



User Manual Of EL7-EC AC Servo

Rev 1.1



Introduction

Thanks for purchasing Leadshine EL7-EC series AC servo drivers, this instruction manual provides knowledge and attention for using this driver.

Contact tech@leadshine.com if you need more technical service .







Incorrect operation may cause unexpected accident, please read this manual carefully before using product.

- ◇ We reserve the right to modify equipment and documentation without prior notice.
- ◇ We won't undertake any responsibility with customer's any modification of product, and the warranty of product will be cancel at the same time.

Safety Items

EL7 Series servo drive, should be mounted in cover type control box during operating. The mounting of drive, wiring and motor should be under the regulations of EN 61800-5-1. Safety items indicate a potential for personal injury or equipment damage if the recommended precautions and safe operating practices are not followed.

The following safety-alert symbols are used on the drive and in the documentation:

 Danger	Indicates great possibility of death or serious injury
 Caution	Indicates something that must be done.
 Warning	Indicates something that must not be done.
	Indicates dangerous voltage.
	Indicates do not touch hot heat sink when power on.
	Protective Earth

Safety precautions

 Warning
<ul style="list-style-type: none"> ● The design and manufacture of product doesn't use in mechanic and system which have a threat to operator. ● The safety protection must be provided in design and manufacture when using this product to prevent incorrect operation or abnormal accident.

Acceptance

 Caution
<ul style="list-style-type: none"> ● The product which is damaged or have fault is forbidden to use.

Transportation



Caution

- The storage and transportation must be in normal condition.
- Don't stack too high, prevent falling.
- The product should be packaged properly in transportation,
- Don't hold the product by the cable, motor shaft or encoder while transporting it.
- The product can't undertake external force and shock.

Installation



Caution

Servo Driver and Servo Motor:

- Don't install them on inflammable substance or near it to preventing fire hazard.
- Avoid vibration, prohibit direct impact.
- Don't install the product while the product is damaged or incomplete.

Servo Driver:

- Must install in control cabinet with sufficient safeguarding grade.
- Must reserve sufficient gap with the other equipment.
- Must keep good cooling condition.
- Avoid dust, corrosive gas, conducting object, fluid and inflammable ,explosive object from invading.

Servo Motor:

- Installation must be steady, prevent drop from vibrating.
- Prevent fluid from invading to damage motor and encoder.
- Prohibit knocking the motor and shaft, avoid damaging encoder.
- The motor shaft can't bear the load beyond the limits.

Wiring



Warning

- The workers of participation in wiring or checking must possess sufficient ability do this job.
- The wiring and check must be going with power off after 10 minutes
- Ground the earth terminal of the motor and driver without fail.
- The wiring should be connected after servo driver and servo motor installed correctly
- After correctly connecting cables, insulate the live parts with insulator.



Caution

- The wiring must be connected correctly and steadily, otherwise servo motor may run incorrectly, or damage the equipment .
- Servo motor U, V, W terminal should be connected correctly , it is forbidden to connect them directly to AC power.
- We mustn't connect capacitors ,inductors or filters between servo motor and servo driver .
- The wire and temperature-resistant object must not be close to radiator of servo driver and motor.
- The freewheel diode which connect in parallel to output signal DC relay mustn't connect reversely.

Debugging and running



Caution

- Make sure the servo driver and servo motor installed properly before power on, fixed steadily, power voltage and wiring correctly.
- The first time of debugging should be run without loaded, debugging with load can be done after confirming parameter setting correctly, to prevent mechanical damage because of error operation.

Using



Caution

- Install a emergency stop protection circuit externally, the protection can stop running immediately to prevent accident happened and the power can be cut off immediately.
- The run signal must be cut off before resetting alarm signal, just to prevent restarting suddenly.
- The servo driver must be matched with specified motor.
- Don't power on and off servo system frequently, just to prevent equipment damaged.
- Forbidden to modify servo system.

Fault Processing



Warning

- The high voltage also will contain in several minutes even if the servo driver is powered off, please don't touch terminal strip or separate the wiring.
- The workers of participation in wiring or checking must possess sufficient ability do this job.



Caution

- The reason of fault must be figured out after alarm occurs, reset alarm signal before restart.
- Keep away from machine, because of restart suddenly if the driver is powered on again after momentary interruption(the design of the machine should be assured to avoid danger when restart occurs)

Introduction	1
List of abbreviations in the manual.....	9
Chapter 1 Introduction.....	10
1.1 Product Introduction.....	10
1.2 Inspection of product.....	10
Chapter 2 Product Specification.....	11
2.1 Driver Technical Specification.....	11
2.2 Accessory selection.....	12
Chapter 3 Installation and Wring.....	13
3.1 Storage and Installation Circumstance.....	13
3.2 Servo Driver Installation.....	13
3.3 Servo Motor Installation.....	14
3.4 <i>Wiring</i>	14
3.4.1 Wire Gauge.....	15
3.4.2 EL7-EC Wiring.....	17
3.5 Driver Terminals Function.....	18
3.5.1 Control Signal Port-CN1 Terminal.....	18
3.5.2 Encoder Input Port-CN2 Terminal.....	19
3.5.3 EtherCAT Communication Port.....	19
3.5.4 USB Communication Port.....	19
3.5.5 Power Port.....	20
3.6 I/O Interface Principle.....	20
3.6.1 Switch Input Interface.....	20
3.6.2 <i>Switch Output Interface</i>	22
Chapter 4 Display and Operation.....	24
4.1 Introduction.....	24
4.2 Panel Display and Operation.....	25
4.2.1 Panel Operation Flow Figure.....	25
4.2.2 Driver Operating Data Monitor.....	26
4.2.3 Auxiliary Function.....	30
4.2.4 Saving parameter.....	30
4.2.5 Initialization of parameter.....	31
4.3 Trial Run.....	32
4.3.1 Inspection Before trial Run.....	33
4.3.2 Trial Run Jog Control.....	33
Chapter 5 Parameter.....	34
5.1 Parameter List.....	34
5.1.1 Drive parameter.....	34
5.1.2 Manufacturer parameter.....	37
5.1.3 Motion parameter starting with object dictionary 6000.....	39
5.2 Parameter Function.....	42
5.2.1 【Class 0】 Basic Setting.....	42
5.2.2 【Class 1】 Gain Adjust.....	45
5.2.3 【Class 2】 Vibration Suppression.....	50
5.2.4 【Class 3】 Velocity/ Torque Control.....	52
5.2.5 【Class 4】 I/F Monitor Setting.....	53
5.2.6 【Class 5】 Extended Setup.....	58
5.2.7 【Class 6】 Special Setup.....	62
5.3 402 Parameters Function.....	64
Chapter6 EtherCAT.....	72
6.1 EtherCAT Introduction.....	72
6.2 Synchronous Mode.....	72
6.2.1 Free Operation Mode.....	72
6.2.2 Distributed clock synchronization mode.....	73
6.3 EtherCAT communication state.....	73

6.4 CANopen Over EtherCAT	74
6.4.1 Network structure of EL7-EC	74
6.4.2 Object dictionary	75
6.4.3 Service Data Objects(SDO)	75
6.4.4 Process Data Objects(PDO)	75
6.5 Slave station alias and network status display	77
6.5.1 Setting	77
6.5.2 Network status display	77
Chapter7 EL7-EC Control Mode	79
7.1 EL7-EC motion control procedure	79
7.2 CIA402 State Machine	79
7.2.1 State machine switchover diagram	79
7.3 Drive Mode Setting	80
7.3.1 Driver Mode Description (6502h)	80
7.3.2 Operation mode setting(6060h) and Opreation mode display (6061h)	81
7.4 Common Functions for All Modes	81
7.4.1 Digital Input/Output	81
7.4.2 Motor Rotation Direction	83
7.4.3 Drive Stop	83
7.4.4 Electronic Gear Ratio	83
7.4.5 Position Limits	84
7.4.6 Control Word	84
7.4.7 Status Word	85
7.4.8 Drive Enable	86
7.4.9 Communication Cycle	86
7.5 Position Mode (CSP、PP、HM)	87
7.5.1 Common Functions of Position Mode	87
7.5.2 Cyclic Synchronous Position Mode (CSP)	88
7.5.3 Profile Position Mode (PP)	91
7.5.4 Homing Mode (HM)	94
7.6 Velocity Mode (CSV、PV)	112
7.6.1 Common Functions of Velocity Mode	112
7.6.2 Cyclic Synchronous Velocity Mode (CSV)	113
7.6.3 Profile Velocity Mode (PV)	115
7.7 Torque Mode (CST、PT)	117
7.7.1 Common Functions of torque Mode	117
7.7.2 Cyclic Synchronous Torque Mode (CST)	118
7.7.3 Profile Torque Mode (PT)	119
Chapter 8 Application Case	121
8.1 Multi-turn absolute encoder	121
8.1.1 Parameters setting	121
8.1.2 Read absolute position	121
8.1.3 Alarm	122
8.2 Touch Probe Function (Latch Function)	123
8.2.1 Block Diagram	124
8.2.2 Related Objects	125
8.2.3 Signal Input of EXT1 and EXT2	125
8.2.4 Touch Probe Control Word 60B8h	125
8.2.5 Touch Probe Statue Word 60B9h	126
8.2.6 Latch Position Register	126
8.2.7 Latch Counter Register	127
8.2.8 Touch Probe mode	127
8.3 Security Features	128
8.3.1 Torque Limit (TL-SEL)	128
8.3.2 Emergency Stop Time at Alarm	129
8.3.5 Emergency Stop	129
8.4 Gain Adjustment	129

8.5 Inertia Ratio Identification	130
8.5.1 On-line Inertia Ratio Identification	130
8.5.2 Off-line Inertia Ratio Identification	130
8.6 Vibration Suppression	131
8.7 Other Functions	132
8.7.1 Zero Speed Output (ZSP)	132
8.7.2 Position Setup Unit Select	133
8.7.3 EtherCAT slave ID	133
8.7.4 Friction Torque compensation	133
Chapter 9 Alarm and Processing	134
9.1 Alarm List	134
9.2 Alarm Processing Method	136
9.3 EtherCAT Communication Alarm	142
9.4 Alarm clear	142
9.4.1 Servo Drive Alarm	142
9.4.2 EtherCAT Communication Alarm	142
Contact us	143

List of abbreviations in the manual

Abbreviation	Full name in English
Bit/S	Bit Per Second
COE	CANopen Over EtherCAT
IP	Init To Pre-Operation
PI	Pre-Operational To Init
PS	Pre-Operational To Safe-Operational
SP	Safe-Operational To Pre-Operational
SO	Safe-Operational To Operational
OS	Operational To Safe-Operational
OI	Operational To Init
SI	Safe-Operational To Init
VS	Versus
PDO	Process Data Objects
SDO	Service Data Objects
SM	Synchronization Manager
FMMU	Fieldbus Memory Management Uint
h	Hex
U8	Unsigned Char
U16	Unsigned Short
U32	Unsigned Long
I8	signed Char
I16	signed Short
I32	signed Long
RW	Read Write
RO	Read Only
WO	Write Only
Var	Variable
Array	Array
ETG	EtherCAT Technology Group
ESC	EtherCAT Slave Controller
ESM	EtherCAT State Machine
SIn	Signal Input
SO _n	Signal Output
PP	Profile Position Mode
PV	Profile Velocity Mode
PT	Profile Torque Mode
HM	Homing Mode
CSP	Cyclic Synchronous Position Mode
CSV	Cyclic Synchronous Velocity Mode
CST	Cyclic Synchronous Torque Mode
Uint	——
Uint/S	——
Uint/S ²	——
P	Pulse
S	Second
RPM	Revolutions Per Minute

Chapter 2 Product Specification



Notice

Servo driver must be matched with relevant servo motor, this manual describes Leadshine EL7 series servo motor.

Contact tech@leadshine.com if you need more technical service .

2.1 Driver Technical Specification

Table 2.1 Driver Specification

Parameter	EL7-EC400Z	EL7-EC750Z	EL7-EC1000Z	EL7-EC1500Z	EL7-EC2000Z
Rated output power	400W	750W	1KW	1.5KW	2KW
Rated output current	2	3.7	5	7.5	10.5
Max output current	8.5	16	22	25	30
Main power	Single phase or three phase 220V -15%~+10% 50/60HZ				
Control power	Single phase 220V -15%~+10%				
Control mode	IGBT SVPWM sinusoidal wave control				
Feedback mode	17bit single-turn incremental encoder/23bit multi-turn absolute encoder				
Command source	EtherCAT				
Adjust speed ratio	6000:1				
Position bandwidth	200HZ				
Electronic gear ratio	1~32767/1~32767				
Velocity bandwidth	500HZ				
Input signal	DI: 14 inputs (Support common + and common - two wiring modes) over-travel inhibition, gain switching, command pulse inhibition, speed zero clamp, deviation counter clear, alarm clear				
Output signal	DO: 6 outputs (4 single-ended, 2 differential) Alarm output, servo-ready, at-speed, zero-detection, velocity coincidence, HOME-OK				
Encoder signal output	A phase, B phase, Z phase, long-distance drive mode output				
Alarm function	Over-voltage, under-voltage, over-current, over-load, encoder error, position deviation error, brake alarm, limit alarm, over-speed error etc.				
Operation and display	jog, trapezoidal wave test, each parameter and input output signal can be modified and saved, six-bit LED to display rotational speed, current, position deviation, driver type version and address ID value etc.				
Debug software	Can adjust the parameters of current loop, velocity loop, position loop , and change the value of input and output signals and the parameter of motor and save the values to the files which can be downloaded and uploaded, monitor the waveform of velocity and position in the ladder.				
Communication interface	USB: Based on Modbus protocol (according to USB2.0 specification) RS485				
Brake mode	Built-in brake 50Ω/50W				
Adapt load inertia weight	Less than 30 times motor inertia About 1.5-3Kg				
Environment	Environment	Avoid dust, oil fog and corrosive gases			
	Ambient Temp	0 to +40℃			
	Humidity	40% RH to 90%RH, no condensation			
	Vibration	5.9 m/s ² MAX			
	Storage Temperature	-20~80℃			
	Installation	Vertical installation			

2.2 Accessory selection

1. Motor cable
CABLE-RZ3M0-S (V3.0)
2. Encoder cable
CABLE-7BM3M0-Z(V3.0)
3. Brake cable (if necessary)
CABLE-SC3M0-S(V3.0)
4. Software configuration cable
CABLE-USB1M5
5. Control signal terminal CN1 (44 pin)
6. Control signal shell CN1

Chapter 3 Installation and Wring

3.1 Storage and Installation Circumstance

Table 3.1 Servo Driver, Servo Motor Storage Circumstance Requirement

Item	EL7 series driver	servo motor
Temperature	-20-80°C	-25-70°C
Humility	Under 90%RH (free from condensation)	Under 80%RH (free from condensation)
Atmospheric environment	Indoor(no exposure)no corrosive gas or flammable gas, no oil or dust	Indoor(no exposure)no corrosive gas or flammable gas, no oil or dust
Altitude	Lower than 1000m	Lower than 2500m
Vibration	Less than 0.5G (4.9m/s ²) 10-60Hz (non-continuous working)	
Protection level	IP00(no protection)	IP54

Table 3.2 Servo Driver, Servo Motor Installation Circumstance Requirement

Item	EL7 series driver	servo motor
Temperature	0-55°C	-25-40°C
Humility	Under 90%RH (free from condensation)	Under 90%RH (free from condensation)
Atmospheric environment	Indoor(no exposure)no corrosive gas or flammable gas, no oil or dust	Indoor(no exposure)no corrosive gas or flammable gas, no oil or dust
Altitude	Lower than 1000m	Lower than 2500m
Vibration	Less than 0.5G (4.9m/s ²) 10-60Hz (non-continuous working)	
Protection level	IP00(no protection)	IP54

Contact tech@leadshine.com if you need more technical service .

3.2 Servo Driver Installation

Notice

- Must install in control cabinet with sufficient safeguarding grade.
- Must install with specified direction and intervals, and ensure good cooling condition.
- Don't install them on inflammable substance or near it to prevent fire hazard.

Install in vertical position ,and reserve enough space around the servo driver for ventilation.

The user may install the product in the mode of bottom plate installation or panel installation, and the installation direction is perpendicular to the installation face. In order to ensure good heat dissipation conditions, at least 10MM of installation space should be set aside in the actual installation.

When mounting drives compactly, consider installation tolerances and leave at least 1MM between each two drives. Use it below 75% of the actual load rate.

Here is the installation diagram:

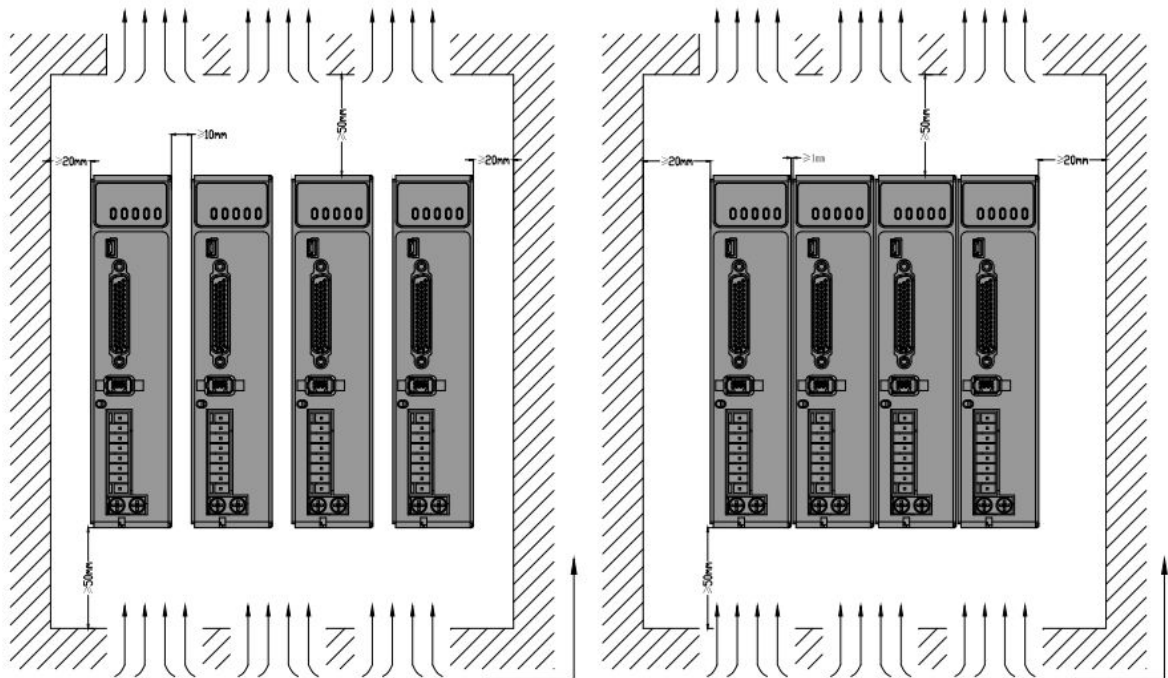

3.3 Servo Motor Installation



Notice

- Don't hold the product by the cable, motor shaft or encoder while transporting it.
- No knocking motor shaft or encoders, prevent motor by vibration or shock.
- The motor shaft can't bear the load beyond the limits.
- Motor shaft does not bear the axial load, radial load, otherwise you may damage the motor.
- Use a flexible with high stiffness designed exclusively for servo application in order to make a radial thrust caused by micro misalignment smaller than the permissible value.
- Install must be steady, prevent drop from vibrating.

3.4 Wiring



Warning

- The workers of participation in wiring or checking must possess sufficient ability do this job.
- The wiring and check must be going with power off after five minutes.



Caution

- Ground the earth terminal of the motor and driver without fail.
- The wiring should be connected after servo driver and servo motor installed correctly

3.4.1 Wire Gauge

- (1) Power supply terminal TB
- Diameter:

Table 3.3 Power wiring specification

Driver	Wire diameter (mm ² /AWG)			
	r, t	P+, BR	U, V, W	PE
EL7-*0400	0.81/AWG18	2.1/AWG14	1.3/AWG16	2.1/AWG14
EL7-*0750	0.81/AWG18	2.1/AWG14	1.3/AWG16	2.1/AWG14
EL7-*1000	0.81/AWG18	2.1/AWG14	2.1/AWG14	2.1/AWG14

- Grounding: The grounding wire should be as thick as possible, drive servo motor the PE terminal point ground, ground resistance <100 Ω.
- Use noise filter to remove external noise from the power lines and reduce an effect of the noise generated by the servo driver.
- Install fuse (NFB) promptly to cut off the external power supply if driver error occurs.

(2) The control signal CN1 feedback signal CN2

- Diameter: shielded cable (twisting shield cable is better), the diameter $\geq 0.14\text{mm}^2$ (AWG24-26), the shield should be connected to FG terminal.
- Length of line: cable length should be as short as possible and control CN1 cable is no more than 3 meters, the CN2 cable length of the feedback signal is no more than 20 meters.
- Wiring: be away from the wiring of power line, to prevent interference input.
- Install a surge absorbing element for the relevant inductive element (coil); DC coil should be in parallel connection with freewheeling diode reversely; AC coil should be in parallel connection with RC snubber circuit.

(3) Regenerative resistor

When the torque of the motor is opposite to the direction of rotation (common scenarios such as deceleration, vertical axis descent, etc.), energy will feedback from the load to the driver. At this time, the energy feedback is first received by the capacitor in the driver, which makes the voltage of the capacitor rise. When it rises to a certain voltage value, the excess energy needs to be consumed by the regenerative resistance

The recommended regenerative resistance specifications for the EL7 series are as follows:

Table 3.4 Regenerative resistance specification sheet

Driver	Built-in resistor value (Ω)	Built-in resistor power (W)
EL7-*0400	100	50
EL7-*0750	50	50
EL7-*1000	50	100

Method for determining regenerative resistance specification

- Firstly, use the built-in resistance of the driver to run for a long time to see if it can meet the requirements: ensure that the driver temperature $d33 < 60^\circ\text{C}$, the braking circuit does not alarm (Regeneration load factor $d14 < 80$), and the driver does not report overvoltage error
- If the driver temperature is high, try to reduce the regenerative energy power, or external resistance of the same specification (in this case, cancel the built-in resistance).
- If the brake resistance burns out, try to reduce the regenerative energy power, or put an external resistance of the same specification or even more power (in this case, cancel the built-in resistance).
- If $d14$ is too large or accumulates too fast, it means that the regenerative energy is too large,

and the built-in resistance cannot consume the generated energy, the regenerative energy power will be reduced, or the external resistance with higher resistance value or power will be reduced.

- If an overvoltage error is reported by the driver, the regenerative energy power is reduced, or a resistance with a smaller external resistance, or a parallel resistance.

**Attention**

- Match the colors of the motor lead wires to those of the corresponding motor output terminals (U.V.W)
- Never start nor stop the servo motor with this magnetic contactor.
- Cable must be fixed steadily, avoid closing to radiator and motor to prevent reducing the properties of heat insulation

3.4.2 EL7-EC Wiring

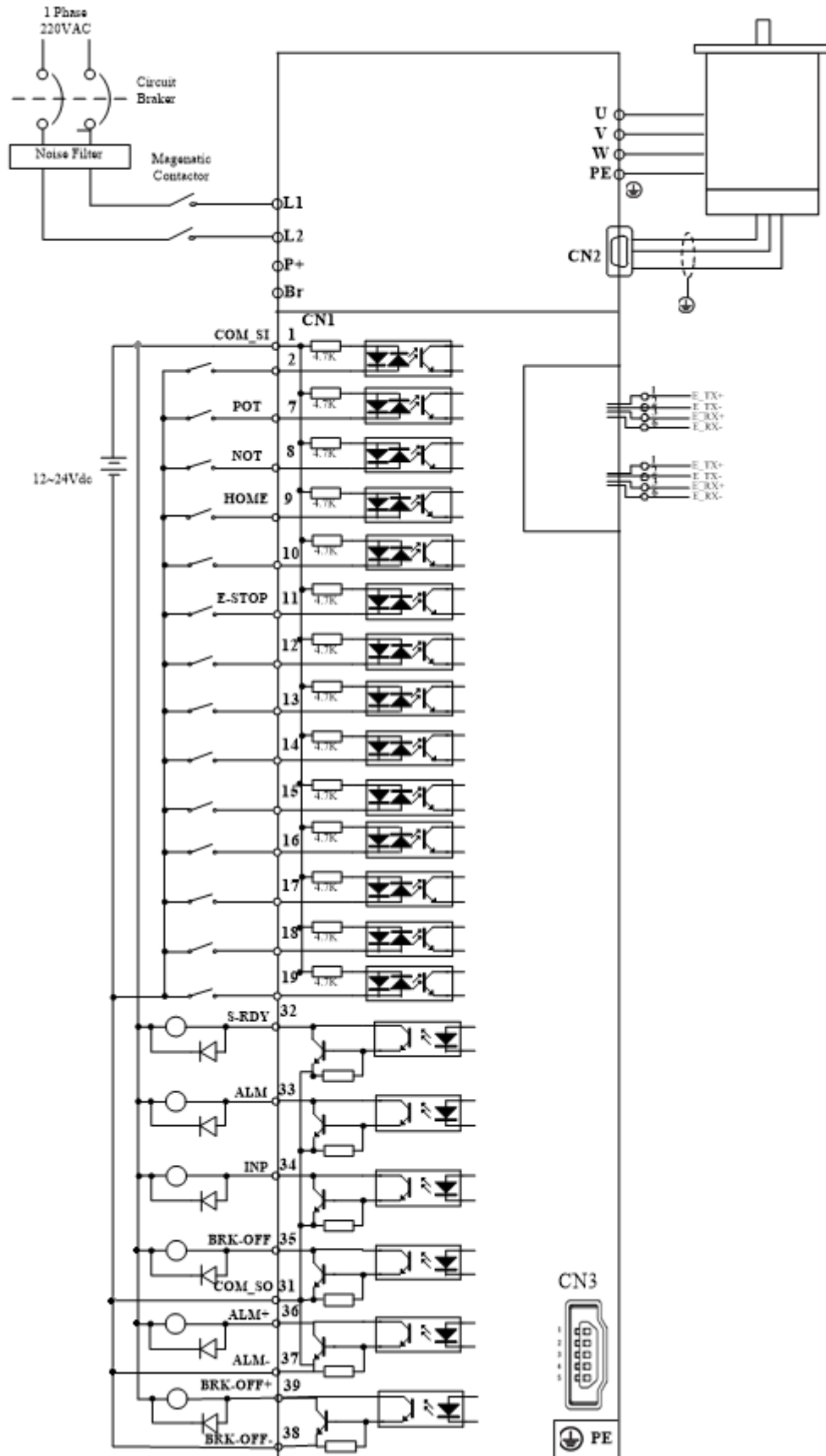

3.5 Driver Terminals Function

Table 3.5 Functions of driver port

Port	Function
CN1	Control Signal Port
CN2	Encoder Input Port
CN3	USB Communication Port
CN4	EtherCAT Communication Port
CN5	EtherCAT Communication Port
X1	Power Port

3.5.1 Control Signal Port-CN1 Terminal

Table3.6 Signal Explanation of Control Signal Port-CN1

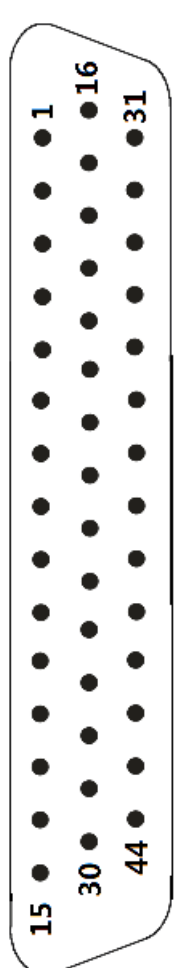
Port		Pin	Signal	I/O	Name	Explanation
CN1		1	COM_SI	input	Digital input common terminal, Com+/Com-, 12VDC~24VDC	Two-way digital input with common terminal, function can be configured. 12VDC ~ 24VDC
		2	SI1	input	Digital input 1	
		3	EXT1 +	Touch	Differential input,24VDC	
		4	EXT1 -	Probe 1		
		5	EXT2 +	Touch	Differential input,24VDC	
		6	EXT2 -	Probe 2		
		7	SI2	input	Digital input 2	
		8	SI3	input	Digital input 3	
		9	SI4	input	Digital input 4	
		10	SI5	input	Digital input 5	
		11	SI6	input	Digital input 6	
		12	SI7	input	Digital input 7	
		13	SI8	input	Digital input 8	
		14	SI9	input	Digital input 9	
		15	SI10	input	Digital input 10	
		16	SI11	input	Digital input 11	
		17	SI12	input	Digital input 12	
		18	SI13	input	Digital input 13	
		19	SI14	input	Digital input 14	
		31	COM_SO	output	Digital output common- terminal	Low resistor output in default . OC, the maximum voltage/current is no more than 30V, 50mA . Recommend the voltage : 12 V-24V. Current :10mA
		33	SO1 +	output	Digital output 1	
		32	SO2 +	output	Digital output 2	
		34	SO3 +	output	Digital output 3	
35	SO4 +	output	Digital output 4	Differential Digital output , the maximum voltage/current is no more than 30V/50mA . Recommended voltage : 12 -24V. Current :10mA		
36	SO5 +	output	Differential Digital output 5			
37	SO5-	output		Differential Digital output 6		
38	SO6+	output				
39	SO6-	output				
Shell	FG		Shield ground			

3.5.2 Encoder Input Port-CN2 Terminal

Table3.7 Encoder Input Port-CN2 Terminal Signal Explain

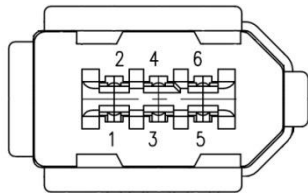
Port		Pin	Signal
CN2		1	VCC5V
		2	GND
		3	BAT+
		4	BAT-
		5	SD+
		6	SD-
			PE

3.5.3 EtherCAT Communication Port

Table3.8 Signal explanation of driver interconnection interface-CN4 CN5

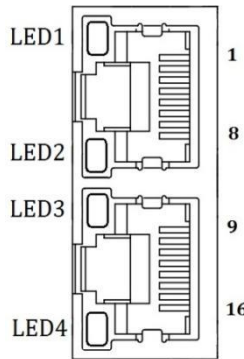
Port		Pin	Signal
CN4 CN5		1, 9	E_TX+
		2, 10	E_TX-
		3, 11	E_RX+
		4, 12	--
		5, 13	--
		6, 14	E_RX-
		7, 15	--
		8, 16	--
		PE	
Notes	① LED1 is "Link/Activity IN" status display, Green; ② LED3 is "Link/Activity OUT" status display, Green; ③ LED2 is "RUN" status display, Orange; ④ LED4 is "ERR" status display, Orange.		

3.5.4 USB Communication Port

Table3.9 USB Communication Port –CN3

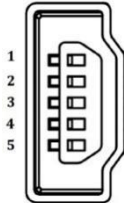
Port		Pin	Signal
CN3		1	VCC5V
		2	D+
		3	D-
		4	
		5	GND
			USB_GND

3.5.5 Power Port

Table3.10 Main Power Input Port-X1

Port	Pin	Signal	Detail						
X1	L1	For single phase 220V	For single phase 220V , +15 ~ -15% , 50/60Hz						
	L2	For single phase 220V							
Notes	① Isolation transformer can be used for power supply; ② Do not access the 380VAC power supply, or it will cause serious damage to the drive; ③ In the case of serious interference, it is recommended to use noise filter for power supply; ④ It is recommended to install a non-fusible circuit breaker to cut off external power supply in time when the driver fails.								
Port	Pin	Signal	Detail						
X1	P +	Dc bus + terminal	① Driver Dc bus + terminal ② External regenerative resistor P terminal						
	Br	External regenerative resistor terminal	External regenerative resistor terminal						
Notes	When using external resistors, the values of resistance and power are selected as follows : <table border="1" style="margin-left: 40px;"> <thead> <tr> <th>Driver</th> <th>Resistor (Ω)</th> <th>Power (W)</th> </tr> </thead> <tbody> <tr> <td>EL7-EC400Z</td> <td>≥ 40</td> <td>100</td> </tr> </tbody> </table>			Driver	Resistor (Ω)	Power (W)	EL7-EC400Z	≥ 40	100
Driver	Resistor (Ω)	Power (W)							
EL7-EC400Z	≥ 40	100							
Port	Pin	Signal	Detail						
X1	U	U	3 phase motor power input						
	V	V							
	W	W							
	PE	PE	Frame ground						
Notes	Connect the driver to the ground end (PE) of the motor and connect it to the earth								

3.6 I/O Interface Principle

3.6.1 Switch Input Interface

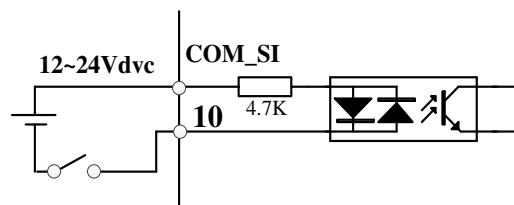
Switch Input Interface

(1)The user provide power supply, DC 12-24V, current \geq 100mA

Pr4.00	Name	Input selection SI1			Mode						F
	Range	0~00FFFFFFh	Unit	—	Default	0		Index		2400h	
Pr4.01	Name	Input selection SI2			Mode						F
	Range	0~00FFFFFFh	Unit	—	Default	000001		Index		2401h	
Pr4.02	Name	Input selection SI3			Mode						F
	Range	0~00FFFFFFh	Unit	—	Default	000002		Index		2402h	
Pr4.03	Name	Input selection SI4			Mode						F
	Range	0~00FFFFFFh	Unit	—	Default	000016		Index		2403h	
Pr4.04	Name	Input selection SI5			Mode						F
	Range	0~00FFFFFFh	Unit	—	Default	000007		Index		2404h	
Pr4.05	Name	Input selection SI6			Mode						F
	Range	0~00FFFFFFh	Unit	—	Default	000014		Index		2405h	
Pr4.06	Name	Input selection SI7			Mode						F
	Range	0~00FFFFFFh	Unit	—	Default	0		Index		2406h	
Pr4.07	Name	Input selection SI8			Mode						F
	Range	0~00FFFFFFh	Unit	—	Default	0		Index		2407h	
Pr4.08	Name	Input selection SI9			Mode						F
	Range	0~00FFFFFFh	Unit	—	Default	0		Index		2408h	
Pr4.09	Name	Input selection SI10			Mode						F
	Range	0~00FFFFFFh	Unit	—	Default	0		Index		2409h	
Pr4.44	Name	Input selection SI11			Mode						F
	Range	0~00FFFFFFh	Unit	—	Default	0		Index		2444h	
Pr4.45	Name	Input selection SI12			Mode						F
	Range	0~00FFFFFFh	Unit	—	Default	0		Index		2445h	
Pr4.46	Name	Input selection SI13			Mode						F
	Range	0~00FFFFFFh	Unit	—	Default	0		Index		2446h	
Pr4.47	Name	Input selection SI14			Mode						F
	Range	0~00FFFFFFh	Unit	—	Default	0		Index		2447h	

Set SI1 input function allocation.

This parameter use 16 binary system to set up the values,

For the function number, please refer to the following Figure.

Signal name	Symbol	Set value		0x60FD(bit)
		a-contact	b- contact	
Invalid	—	00h	Do not setup	×
Positive direction over-travel inhibition input	POT	01h	81h	1
Negative direction over-travel inhibition input	NOT	02h	82h	0
Alarm clear input	A-CLR	04h	Do not setup	
Forced alarm input	E-STOP	14h	94h	
HOME-SWITCH	HOME-SWITCH	16h	96h	2

- a-contact means input signal comes from external controller or component ,for example: PLC .
- b-contact means input signal comes from driver internally.
- Don't setup to a value other than that specified in the table .
- Don't assign specific function to 2 or more signals. Duplicated assignment will cause Err21.0 I/F input multiple assignment error 1or Err21.1 I/F input multiple assignment error 2.
- E-STOP: Associated parameter Pr4.43

I/O input digital filtering

Pr5.15 *	Name	I/F reading filter			Mode							F
	Range	0~255	Unit	0.1ms	Default	0	Index		2515h			
I/O input digital filtering; higher setup will arise control delay.												

3.6.2 Switch Output Interface

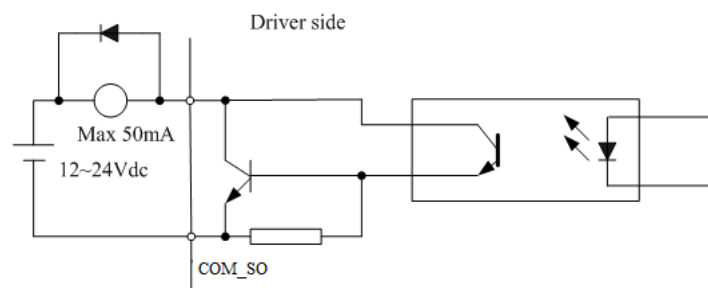

Switch Output Interface

- (1) The user provide the external power supply . However, if current polarity connects reversely, servo driver is damaged.
- (2) The output of the form is open-collector, the maximum voltage is 25V, and maximum current is 50mA. Therefore, the load of switch output signal must match the requirements. If you exceed the requirements or output directly connected with the power supply, the servo drive is damaged.
- (3) If the load is inductive loads relays, etc., there must be anti-parallel freewheeling diode across the load. If the freewheeling diode is connected reversely, the servo drive is damaged.
- (4) 32、 33、 34、 35、 31 Pin: Single-ended output;
36、 37 Pin , 38、 39 Pin: Differential output.

Pr4.10	Name	Output selection SO1			Mode						F
	Range	0~00FFFFFFh	Unit	—	Default	000001h	Index		2410h		
Pr4.11	Name	Output selection SO2			Mode						F
	Range	0~00FFFFFFh	Unit	—	Default	000002h	Index		2411h		
Pr4.12	Name	Output selection SO3			Mode						F
	Range	0~00FFFFFFh	Unit	—	Default	000004h	Index		2412h		
Pr4.13	Name	Output selection SO4			Mode						F
	Range	0~00FFFFFFh	Unit	—	Default	000003h	Index		2413h		
Pr4.14	Name	Output selection SO5			Mode						F
	Range	0~00FFFFFFh	Unit	—	Default	0	Index		2414h		
Pr4.15	Name	Output selection SO6			Mode						F
	Range	0~00FFFFFFh	Unit	—	Default	0	Index		2415h		

Assign functions to SO1 outputs.

This parameter use 16 binary system do setup

For the function number, please refer to the following Figure.

Signal name	Symbol	Setup value	
		a-contact	b- contact
Master control output	—	00h	Do not setup
Alarm output	Alm	01h	81h
Servo-Ready output	S-RDY	02h	82h
Eternal brake release signal	BRK-OFF	03h	83h
Positioning complete output	INP	04h	84h
At-speed output	AT-SPPED	05h	85h
Torque limit signal output	TLC	06h	86h
Zero speed clamp detection output	ZSP	07h	87h
Velocity coincidence output	V-COIN	08h	88h
Positional command ON/OFF output	P-CMD	0Bh	8Bh
Speed limit signal output	V-LIMIT	0Dh	8Dh
Speed command ON/OFF output	V-CMD	0Fh	8Fh
Servo enable state output	SRV-ST	12h	92h
Homing process finish	HOME-OK	22h	A2h

- a contact: Active low b contact: Active high
- In EtherCAT mode, the arrival signal in pp, pv and pt mode is consistent with INP, v-coin and TLC signals respectively, and is reflected in bit24 in 60FD
- Don't setup to a value other than that specified in the table .
- Pr4.10~Pr4.15 correspond to SO1~SO6 respectively. When the parameters are set to all 0, it is the master control output. Bit0 ~bit5 of the object dictionary 0x60FE sub-index 01 corresponds to SO1~SO6 respectively

Chapter 4 Display and Operation

4.1 Introduction

The operation interface of servo driver consists of six LED nixie tubes and five key , which are used for servo driver's status display and parameter setting. The inter face layout is as follows :



Figure 4.1 Front panel

Table 4.1 The name and function of keys

Name	Key	Function
Display	/	There are 6 LED nixie tubes to display monitor value, parameter value and set value
Key of mode switch	M	Press this key to switch among 4 mode: 1.data monitor mode 2.parameter setting mode 3.auxiliary function mode 4.EEPROM written mode
Confirming key	SET	Entrance for submenu, confirming input
Up key	▲	Press this key to increase the set value of current flash bit
Down key	▼	Press this key to decrease the set value of current flash bit
Left key	◀	Press this key to shift to the next digit on the left

4.2 Panel Display and Operation

4.2.1 Panel Operation Flow Figure

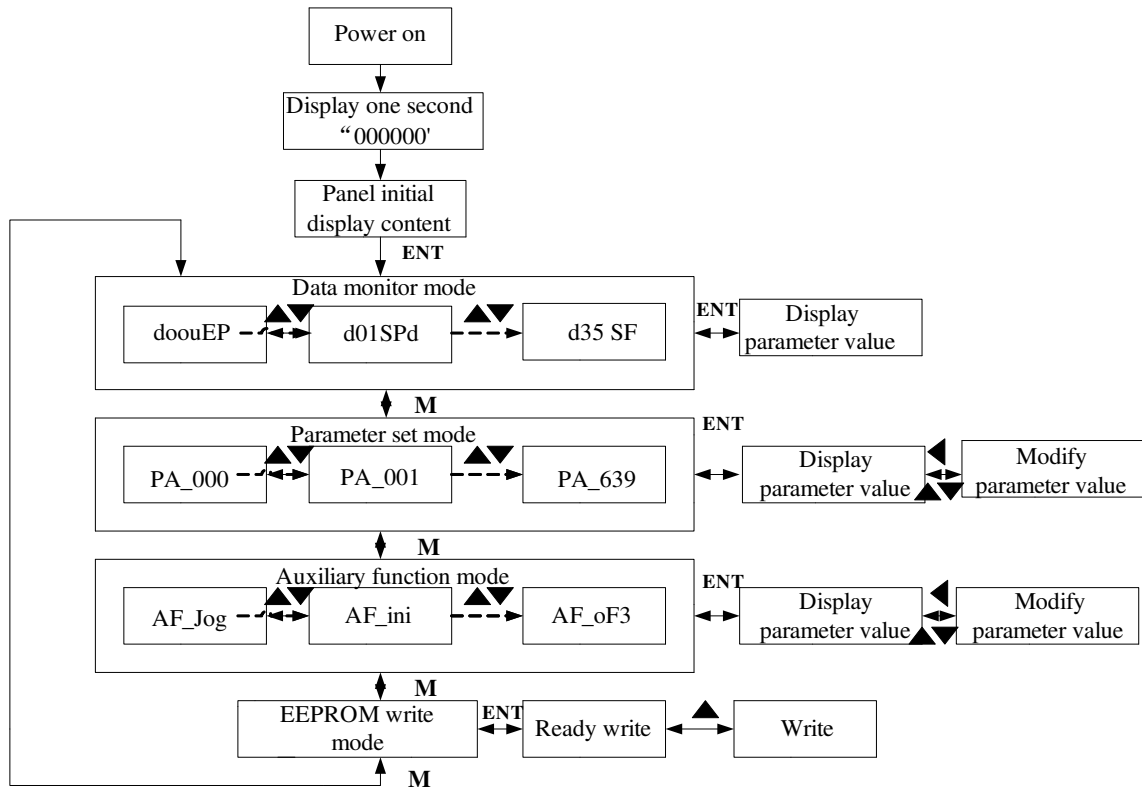

Figure 4.2 The flow diagram of panel operation

- (1) The front panel display **rEAdY** for about one second firstly after turning on the power of the driver. Then if no abnormal alarm occurs, monitor mode is displayed with the value of initial parameter ; otherwise, abnormal alarm code is displayed.
- (2) Press M key to switch the data monitor mode → parameter setting mode → auxiliary function mode → EEPROM written mode.
- (3) If new abnormal alarm occurs, the abnormal alarm will be displayed immediately in abnormal mode no matter what the current mode is, press M key to switch to the other mode.
- (4) In data monitor mode, press ▲ or ▼ to select the type of monitor parameter; Press ENT to enter the parameter type , then press ◀ to display the high 4 bits “H” or low 4 bits “L” of some parameter values.
- (5) In parameter setting mode, press ◀ to select current editing bit of parameter No, press ▲ or ▼ to change current editing bit of parameters No. Press ENT key to enter the parameter setting mode of corresponding parameters No. Press ◀ to select current bit of parameter value when editing it, press ▲ or ▼ to change the value of the bit. Press ENT to save it and switch to the interface of parameter No.

4.2.2 Driver Operating Data Monitor

Table 4.2 Function List of Driver Monitor

Num	Name	Specification	Display	Unit	Data Format (x, y is numerical value)
0	d00uE	Positional command deviation	d00uE	pulse	Low-bit "L xxxx" High-bit "H xxxx"
1	d01SP	Motor speed	d01SP	r/min	"r xxxx"
2	d02cS	Positional command speed	d02CS	r/min	"r xxxx"
3	d03cu	Velocity control command	d03Cu	r/min	"r xxxx"
4	d04tr	Torque command	d04tr	%	"r xxxx"
5	d05nP	Feedback pulse sum	d05nP	pulse	Low-bit "L xxxx" High-bit "H xxxx"
6	d06cP	Command pulse sum	d06CP	pulse	Low-bit "L xxxx" High-bit "H xxxx"
7	d07	Maximum torque during motion	d07	/	" xxxx"
8	d08FP	External scale feedback pulse sum	d08FP	pulse	Low-bit "L xxxx" High-bit "H xxxx"
9	d09cn	Control mode	d09Cn	/	Position: "PoScn" Speed: "SPdcn" Torque: "trqcn" Composite mode: " cnt"
10	d10Io	I/O signal status	d10 Io	/	Refer instructions for details
11	d11Ai	/	d11Ai	v	
12	d12Er	Error factor and reference of history	d12Er	/	"Er xxx"
13	d13 rn	Alarm display	d13rn	/	"m xxx"
14	d14 r9	Regeneration load factor	d14r9	%	"rg xxx"
15	d15 oL	Over-load factor	d15oL	%	"oL xxx"
16	d16Jr	Inertia ratio	d16Jr	%	"J xxx"
17	d17ch	Factor of no-motor running	d17Ch	/	"cP xxx"
18	d18ic	No. of changes in I/O signals	d18ic	/	"n xxx"
19	d19	/	d19	/	" xxxx"
20	d20Ab	Absolute encoder data	d20Ab	pulse	Low-bit "L xxxx" High-bit "H xxxx"
21	d21AE	Absolute external scale position	d21AE	pulse	Low-bit "L xxxx" High-bit "H xxxx"
22	d22rE	No of Encoder/external scale communication errors monitor	d22rE	times	"n xxx"
23	d23 id	Communication axis address	d23id	/	"id xxx" "Fr xxx"
24	d24PE	Encoder positional deviation(encoder unit)	d24PE	pulse	Low-bit "L xxxx" High-bit "H xxxx"
25	d25PF	Encoder scale deviation (external scale unit)	d25PF	pulse	Low-bit "L xxxx" High-bit "H xxxx"
26	d26hy	hybrid deviation (command unit)	d26hy	pulse	Low-bit "L xxxx" High-bit "H xxxx"
27	d27 Pn	Voltage across PN [V]	d27Pn	V	"u xxx"

28	d28 no	Software version	d28no	/	“d xxx” “F xxx” “P xxx”
29	d29AS	Driver serial number	d29AS	/	“n xxx”
30	d30NS	Motor serial number	d30sE	/	Low-bit “L xxxx” High -bit”H xxxx”
31	d31 tE	Accumulated operation time	d31tE	/	Low-bit “L xxxx” High -bit”H xxxx”
32	d32Au	Automatic motor identification	d32Au	/	“r xxx”
33	d33At	Driver temperature	d33At	°C	“th xxx”
34	d34	Servo state	d34	/	“t xxx”
35	d35 SF	Safety condition monitor	d35SF	/	“xxxxxx”
The following are the monitoring parameters associated with the EtherCAT bus					
36	d36	Synchronizing cycle	d36	ms	“xxxxxx”
37	d37	Loss of synchronization	d37	/	“xxxxxx”
38	d38	Synchronization Type	d38	freerun/ DC	“xxxxxx”
39	d39	Whether the DC is running or not	d39	/	“xxxxxx”
40	d40	Acceleration and deceleration state	d40	/	“xxxxxx”
41	d41	Address of object dictionary	d41	/	“xxxxxx” Index(4bit)+subindex(2bit)
42	d42	Value of object dictionary	d42	/	“xxxxxx” 1、 If OD does not exist, display ODNEXT; 2、 If OD is out of range, display ODRNG

Table 4.3 " d34" bus servo state description

LED Display (left to right)	Description
Bit 1	402 State Machine Initialization(1 : The top line power-on)、 Ready(2 : The top and the second line power-on)、 Wait to switch on(3 : The top、 second and the last line power-on)、 Running(O : Enable)、 Stop(II : The left and the right line power-on)
Bit 2	EtherCAT Communication state machine, 0 : No communication between master and slave stations 1: Init 2: Pre-Operational 4: Safe-Operational 8: Operational
Bit 3	Operation mode(1/3/4/6/8/9/A)/
Bit 4、 5	Rn: Runningst: Stop

Instructions:
1、 d01SP Motor speed

11	/	26	Motor mechanical Angle	41	Sub-index of OD index
12	Error factor and reference of history	27	Voltage across PN	42	The value of sub-index of OD index
13	Alarm code	28	Software version		
14	Regenerative load factor	29			

Note: Valid after restart the power.

Table 4. 5 “d17 ch” Motor No Rotate Reason Code Definition

Code	Display Code	Specification	Content
0	cP 1	Working normally	
1	cP 2	DC bus under-voltage	/
2	cP 3	No entry of Srv-On input	The Servo-ON input (SRV-ON) is not connected to COM-
3	cP 4	POT/NOT input is valid	PA_504=0,POT is open , speed command is positive direction NOT is open , speed command is negative direction
4	cP 1	Driver fault	/
5	cP 5	The relay inside the driver isn't closed	/
6	cP 6	Pulse input prohibited (INH)	PA_518=0,INH is open
8	cP 8	CL is valid	PA_517=0,deviation counter clear is connected to COM-
9	cP 9	speed zero-clamp is valid	PA_315=1, speed zero-clamp is open
12	cP 12	The torque limit is too small	In torque mode, the torque limit is too small
13	cP 13	Bus emergency stop in effect	Bus emergency stop in effect
14	cP 14	The synchronization cycle is incorrect in synchronous mode	In CSP/CSV/CST mode, the synchronization cycle is incorrect in synchronous mode
15	cP 15	No startup command in PV mode	No startup command in PV mode
16	cP 16	Double enable IO failed to enable	In EtherCAT mode, external IO enable bus enable are both required to enable the servo drive
17	cP 17	Homing mode received incorrectly	The encoder ID is incorrect or the received homing mode is not supported
20	cP 20	Inactive DC mode	The master station is not configured with DC enablement
21	cP 21	Homing error	A signal that should not be valid under the current homing method is valid
22	cP 22	Software limit valid	Software limit valid
23	cP 23	Unsupported operation mode	Unsupported operation mode, refer to 6502h for the operation mode supported by the driver

4.2.3 Auxiliary Function

Table 4.6 Setting interface System parameter

No	Name	Specification	Display Code	Operation Flow
0	AFjog	Trial run	AFjog	Please refer to the chapter of“trial run”
1	AFInI	Initialization of parameter	AFInI	1. press SET to enter operation, display “InI -”。 2.press ▲ once to display “InI---”, indicated initialization; after finishing it, display“FinSh”。
2	AFunL	Release of front panel lock	AFunL	1. press SET to enter operation, display “unL -”。 2. press ▲ button one time , display “FinSh”,indicated unlock the panel successfully
3	AFAcL	Alarm clear	AFAcL	1. press SET to enter operation, display“AcL -”。 2. press ▲ once , display “FinSh”, indicated alarm clear successfully
4	AFEnc	Motor Angle correction	AFEnc	1、 Press SET once to enter operation, display “Enc -” 2、 press ▲ once , display “StArt”, indicated start to correct the angle, then display“FiniSh”indicated correction finished
5	AFrSt	Soft reset	AFrSt	1、 Press SET once to enter operation, display “rSt -” 2、 Press▲ and hold on, display “StArt” Then, finished
10	AFrSt	Soft reset	AFrSt	3、 Press SET once to enter operation, display “rSt -” 4、 Press▲ and hold on, display “StArt” Then, finished

Table 4.7 The Locked panel conditions

Mode	The Locked panel conditions
Monitor mode	No limitation: all monitored data can be checked.
Parameter set up mode	No parameter can be changed but setting can be checked.
Auxiliary function mode	Cannot be run except for” release of front panel lock”
EEPROM writing mode	No limitation

Set Pr5.35=1 to lock the panel.

4.2.4 Saving parameter

4.2.4.1 Saving parameters by panel operation.

Operation procedure:

1. press M to select EEPROM writing mode, display “EESet”;

2. Press ENT to enter into writing mode operation;
3. Press and hold ▲, display LED from "EP -" to "EP--", then it become "EP---", finally it become "StArt", indicated EEPROM writing operation have been began;
4. "Error" means that writing is unsuccessful, while "Finish" show that the writing is successful; Follow steps 3 and 4 to repeat the operation; the drive may be damaged if repeat of several times still fails. The driver need to repair.
5. The driver need to power off and restart again if writing is successful .

4.2.4.2 Saving parameters by Object Dictionary

Object dictionary	Function	Details
Index 1010h Sub-index 01h	Save all parameters	The master controller can operate 0x1010-01 to save all parameters to EEPROM. If the drive detects that the data of 0x1010-01 sent by the master is 0x65766173, the drive will save the current parameters to EEPROM, and 1010-01=1 after saving process finished.
Index 1010h Sub-index 02h	Save communication parameters	The master controller can operate 0x1010-02 to save all parameters to EEPROM. If the drive detects that the data of 0x1010-02 sent by the master is 0x65766173, the drive will save the communication parameters to EEPROM, and 1010-02=1 after saving process finished.
Index 1010h Sub-index 03h	Save 402 parameters	The master controller can operate 0x1010-03 to save all parameters to EEPROM. If the drive detects that the data of 0x1010-03 sent by the master is 0x65766173, the drive will save the 402 parameters to EEPROM, and 1010-03=1 after saving process finished.
Index 1010h Sub-index 04h	Save manufacturer parameters	The master controller can operate 0x1010-04 to save all parameters to EEPROM. If the drive detects that the data of 0x1010-04 sent by the master is 0x65766173, the drive will save the manufacturer parameters to EEPROM, and 1010-04=1 after saving process finished.

4.2.5 Initialization of parameter

4.2.5.1 Initialization of parameter by Panel Operation

AF_InI	Initialization of parameter	AFInI	2. press SET to enter operation, display "InI -". 2.press ▲ once to display "InI---", indicated initialization; after finishing it, display "FinSh".
--------	-----------------------------	-------	---

4.2.5.2 Initialization of parameter by Object Dictionary

Object dictionary	Function	Details
Index 1011h Sub-index 01h	Initialization all parameters	The master controller can operate 0x1011-01 to save all parameters to EEPROM. If the drive detects that the data of 0x1011-01 sent by the master is 0x64616f6c, the drive will save the current parameters to EEPROM, and 1011-01=1 after saving process finished.
Index 1011h Sub-index 02h	Initialization communication parameters	The master controller can operate 0x1011-02 to save all parameters to EEPROM. If the drive detects that the data of 0x1011-02 sent by the master is 0x64616f6c, the drive will save the communication parameters to EEPROM, and 1011-02=1 after saving process finished.
Index 1011h Sub-index 03h	Initialization 402 parameters	The master controller can operate 0x1011-03 to save all parameters to EEPROM. If the drive detects that the data of 0x1011-03 sent by the master is 0x64616f6c, the drive will save the 402 parameters to EEPROM, and 1011-03=1 after saving process finished.
Index 1011h Sub-index 04h	Initialization manufacturer parameters	The master controller can operate 0x1011-04 to save all parameters to EEPROM. If the drive detects that the data of 0x1011-04 sent by the master is 0x64616f6c, the drive will save the manufacturer parameters to EEPROM, and 1011-04=1 after saving process finished.

4.3 Trial Run



Attention

- Ground the earth terminal of the motor and driver without fail. the PE terminal of driver must be reliably connected with the grounding terminal of equipment.
- The driver power need with isolation transformer and power filter in order to guarantee the security and anti-jamming capability.
- Check the wiring to make sure correct connect before power on.
- Install a emergency stop protection circuit externally, the protection can stop running immediately to prevent accident happened and the power can be cut off immediately.
- If drive alarm occurs, the cause of alarm should be excluded and Svon signal must be invalid before restarting the driver.
- The high voltage also will contain in several minutes even if the servo driver is powered off, please don't touch terminal strip or separate the wiring.

Note: there are two kinds of trial run : trial run without load and trial run with load . The user need to test the driver without load for safety first.

Contact tech@leadshine.com if you need more technical service .

4.3.1 Inspection Before trial Run

Table 4.8 Inspection Item Before Run

No	Item	Content
1	Inspection on wiring	1. Ensure the following terminals are properly wired and securely connected : the input power terminals, motor output power terminal ,encoder input terminal CN2, control signal terminal CN1, communication terminal CN4(it is unnecessary to connect CN1 andCN4 in Jog run mode) 2.short among power input lines and motor output lines are forbidden , and no short connected with PG ground.
2	Confirmation of power supply	1. The range of control power input r, t must be in the rated range. 2. The range of the main power input R, S, T must be in the rated range. 3. Single phase 220VAC input is sufficient if the power of driver is no more 1.5kw .
3	Fixing of position	the motor and driver must be firmly fixed
4	Inspection without load	the motor shaft must not be with a mechanical load.
5	Inspection on control signal	1, all of the control switch must be placed in OFF state. 2, servo enable input Srv_on must be in OFF state.



4.3.2 Trial Run Jog Control





It is unnecessary to connect control signal terminal CN1 and communication terminal CN4 in Jog run mode. It is recommended that motor runs at low speed for safety, while the speed depends on the parameters below:

Table 4.9 Parameter Setup of JOG

No	Parameter	Name	Set Value	Unit
1	Pr0.01	Control mode setting	0、 1	/
2	Pr6.04	JOG trial run command speed	User-specified	rpm
3	Pr6.25	Acceleration of trial running	User-specified	ms/1000rpm

◆JOG trial run operation process

1. set all parameters above corresponding to v JOG ;
2. Enter EEPROM writing mode, and save the value of modified parameters ;
3. The driver need to restart after the value is written successfully;
4. Enter auxiliary function mode, and go to "AFJog "sub-menu;
5. Press ENT once, and display Jog - ";
6. Press  once, and display " Srvon " if no exception occurs; press  once again if "Error " occurs, it should display " Srvon "; If "Error " still occurs, please switch to data monitoring mode "d17 Ch "sub-menu, find the cause why motor doesn't rotate, fix the trouble and try again;
7. In position JOG mode, the motor will rotate directly; if motor doesn't rotate, switch to data monitoring mode d17 Ch "sub-menu, find the cause why motor doesn't rotate, fix the trouble and try again;

In speed JOG mode, press  once, the motor rotates once (hold  will make motor rotating to value of Pr6.04); press  once, the motor rotates once (hold  will make motor rotating to value of Pr 6.04); if motor doesn't rotate, switch to data monitoring mode d17 Ch "sub-menu, find the cause why motor doesn't rotate, fix the trouble and try again;

8. Press SET will exit JOG control in JOG run mode.

Chapter 5 Parameter

5.1 Parameter List

5.1.1 Drive parameter

Mode						Parameter Number		Name	EtherCAT Address	Panel Display	
						Classify	Num				
					F	[Class 0] Basic setting	00	MFC function	2000h	PR_000	
					F		01	control mode setup	2001h	PR_001	
					F		02	real-time auto-gain tuning	2002h	PR_002	
					F		03	selection of machine stiffness at real-time auto-gain tuning	2003h	PR_003	
					F		04	Inertia ratio	2004h	PR_004	
							07	Touch probe polarity setting	2007h	PR_007	
PP	PV		HM	CSP	CSV		08	Command pulse per one motor revolution	2008h	PR_008	
					F		13	1st torque limit	2013h	PR_023	
PP			HM	CSP			14	position deviation excess setup	2014h	PR_014	
							15	Absolute encoder setup	2015h	PR_015	
					F		16	External regenerative discharge resistor setup	2016h	PR_016	
					F		17	External regenerative discharge power value	2017h	PR_017	
					F		23	EtherCAT slave ID	2023h	PR_023	
					F		24	Source of the slave ID	2024h	PR_024	
				CSP			25	Synchronous compensation time 1	2025h	PR_025	
				CSP			26	Synchronous compensation time 2	2026h	PR_026	
PP			HM	CSP			[Class 1] Gain Adjust	00	1st gain of position loop	2100h	PR_100
					F			01	1st gain of velocity loop	2101h	PR_101
					F			02	1st time constant of velocity loop integration	2102h	PR_102
					F			03	1st filter of velocity detection	2103h	PR_103
					F			04	1st time constant of torque filter	2104h	PR_104
PP			HM	CSP				05	2nd gain of position loop	2105h	PR_105
					F			06	2nd gain of velocity loop	2106h	PR_106
					F			07	2nd time constant of velocity loop integration	2107h	PR_107
					F			08	2nd filter of velocity detection	2108h	PR_108
					F			09	2nd time constant of torque filter	2109h	PR_109
PP			HM	CSP		10		Velocity feed forward gain	2110h	PR_110	
PP			HM	CSP		11		Velocity feed forward filter	2111h	PR_111	
PP	PV		HM	CSP	CSV	12	Torque feed forward gain	2112h	PR_112		

Mode						Parameter Number		Name	EtherCAT Address	Panel Display
						Classify	Num			
PP	PV		HM	CSP	CSV		13	Torque feed forward filter	2113h	PR_113
					F		15	Control switching mode	2115h	PR_115
					F		17	Control switching level	2117h	PR_117
					F		18	Control switch hysteresis	2118h	PR_118
					F		19	Gain switching time	2119h	PR_119
					F		37	Special register	2137h	PR_137
						[Class 2] Vibration Restrain Function	00	adaptive filter mode setup	2200h	PR_200
					F		01	1st notch frequency	2201h	PR_201
					F		02	1st notch width selection	2202h	PR_202
					F		03	1st notch depth selection	2203h	PR_203
					F		04	2nd notch frequency	2204h	PR_204
					F		05	2nd notch width selection	2205h	PR_205
					F		06	2nd notch depth selection	2206h	PR_206
					F		07	3rd notch frequency	2207h	PR_207
							14	1st damping frequency	2214h	PR_214
							15	1st damping filter setup	2215h	PR_215
PP			HM	CSP			22	Positional command smooth filter	2222h	PR_222
PP			HM	CSP			23	Positional command FIR filter	2223h	PR_223
	PV				CSV	[Class 3] Speed, Torque Control	12	time setup acceleration	2312h	PR_312
	PV				CSV		13	time setup deceleration	2313h	PR_313
	PV				CSV		14	Sigmoid acceleration/ deceleration time setup	2314h	PR_314
	PV				CSV		16	Speed zero-clamp level	2316h	PR_316
							23	Speed mode zero speed static	2323h	PR_323
					F	[Class 4] I/F Monitor Setting	00	input selection SI1	2400h	PR_400
					F		01	input selection SI2	2401h	PR_401
					F		02	input selection SI3	2402h	PR_402
					F		03	input selection SI4	2403h	PR_403
					F		04	input selection SI5	2404h	PR_404
					F		05	input selection SI6	2405h	PR_405
					F		06	input selection SI7	2406h	PR_406
					F		07	input selection SI8	2407h	PR_407
					F		08	input selection SI9	2408h	PR_408
					F		09	input selection SI10	2409h	PR_409
					F		10	output selection SO1	2410h	PR_410
					F		11	output selection SO2	2411h	PR_411
					F		12	output selection SO3	2412h	PR_412
					F		13	output selection SO4	2413h	PR_413
					F		14	output selection SO5	2414h	PR_414
					F		15	output selection SO6	2415h	PR_415
PP			HM	CSP			31	Positioning complete range	2431h	PR_431
PP			HM	CSP			32	Positioning complete output setup	2432h	PR_432
PP			HM	CSP		33	INP hold time	2433h	PR_433	
					F	34	Zero-speed	2434h	PR_434	
	PV				CSV	35	Speed coincidence range	2435h	PR_435	
	PV				CSV	36	At-speed	2436h	PR_436	
					F	37	Mechanical brake action at stalling setup	2437h	PR_437	
					F	38	Mechanical brake action at	2438h	PR_438	

Mode							Parameter Number		Name	EtherCAT Address	Panel Display
							Classify	Num			
									running setup		
						F		39	Brake action at running setup	2439h	PR_439
						F		43	E-stop function active	2443h	PR_443
						F		44	Input selection SI11	2444h	PR_444
						F		45	Input selection SI12	2445h	PR_445
						F		46	Input selection SI13	2446h	PR_446
						F		47	Input selection SI14	2447h	PR_447
						F		04	Drive inhibit input setup	2504h	PR_504
						F		06	Sequence at servo-off	2506h	PR_506
						F		08	Main power off LV trip selection	2508h	PR_508
						F		09	Main power off detection time	2509h	PR_509
								10	Dynamic braking mode	2510h	PR_510
								11	Torque setup for emergency stop	2511h	PR_511
						F		12	Over-load level setup	2512h	PR_512
						F		13	Over-speed level setup	2513h	PR_513
PP			HM	CSP			[Class 5]	20	Position setup unit select	2520h	PR_520
						F	Extended Setup	21	Selection of torque limit	2521h	PR_521
						F		22	2nd torque limit	2522h	PR_522
						F		28	LED initial status	2528h	PR_528
								33	Touch probe 1 signal compensation time	2533h	PR_533
								34	Touch probe 2 signal compensation time	2534h	PR_534
						F		35	Front panel lock setup	2535h	PR_535
								36	Password for opening group 7 parameter	2536h	PR_536
								37	Torque saturation alarm detection time	2537h	PR_537
								39	3rd torque limit	2539h	PR_539
								01	Encoder zero position compensation	2601h	PR_601
PP			HM	CSP			[Class 6]	04	JOG trial run command speed	2604h	PR_604
PP			HM	CSP			Special Setup	05	Position 3rd gain valid time	2605h	PR_605
PP			HM	CSP				06	Position 3rd gain scale factor	2606h	PR_606
						F		07	Torque command additional value	2607h	PR_607
						F		08	Positive direction torque compensation value	2608h	PR_608
						F		09	Negative direction torque compensation value	2609h	PR_609
								11	Current response setup	2611h	PR_611
								12	Setting of torque limit for zero correction of encoder.	2612h	PR_612

Mode							Parameter Number		Name	EtherCAT Address	Panel Display
							Classify	Num			
						F		13	2nd inertia ratio	2613h	PR_613
						F		14	Emergency stop time at alarm	2614h	PR_614
								20	distance of trial running	2620h	PR_620
								21	waiting time of trial running	2621h	PR_621
								22	cycling times of trial running	2622h	PR_622
								25	Acceleration of trial running	2625h	PR_625
								26	Mode of trial running	2626h	PR_626
								34	Frame error window time	2634h	PR_634
								35	Frame error window	2635h	PR_635
								61	Z signal duration time	2661h	PR_661
								62	Overload warning threshold	2662h	PR_662
								63	upper limit of multi - turn absolute position	2663h	PR_663

5.1.2 Manufacturer parameter

Index	Sub index	Name	Unit	Default	Min	Max	Details
5004	01	RPDO length		8	0	64	
	02	TPDO length		17	0	64	
	03	The number of RPDO		1	0	4	
	04	The number of TPDO		1	0	2	
	05	Sync0 Watchdog counter		0	0	65535	83Bh Alarm detection
	06	Reserved			0	65535	
	07	Sync0 Watchdog limit		4	0	65535	
	08	Sync0 Drift watchdog counter		0	0	65535	83Ch Alarm detection
	09	Sync0 Drift watchdog limit		4	0	65535	
	0A	SM2 watchdog counter		0	0	65535	83Ah Alarm detection
	0B	SM2 Watchdog limit		4	0	65535	
	0C	Application layer SM2/Sync0 watchdog counter		0			
	0D	Application layer SM2/Sync0 watchdog limit		4			
	0E	Reserved			0	500	
	0F	Time interval between SM2 and	ns	0	0	1000000000	832h Alarm detection

Sync0																											
5006	00	Synchronous alarm setting		0xFFFF	0	0xFFFF	Bit0:818h Alarm enable switch Bit1: 819h Bit2: 81Ah Bit3: 824h Bit4: 825h Bit5: Reserved Bit6: Reserved Bit7: 82Ch Bit8: 82Dh Bit9: 832h Bit10~15: Reserved Notes: 0 invalid; 1 valid																				
5010	00	PDO watchdog overtime	ms	0	0	60000	0: invalid; > 0: valid; Unit: ms; Such as RPDO timeout alarm 818h, TPDO timeout alarm 819h																				
5012	04	Homing setting	-	5	Bit0: Abnormal signal protection 0: invalid; 1: valid Bit1: pull back if overtravel while final stop 0: invalid; 1: valid Bit2/Bit3: <table border="1" data-bbox="837 929 1444 1254"> <thead> <tr> <th>Bit2</th> <th>Bit3</th> <th>Positive limit position</th> <th>Negative limit position</th> <th>Feedback after the homing process</th> </tr> </thead> <tbody> <tr> <td>0</td> <td>0</td> <td>607D-02+607C</td> <td>607D-01+607C</td> <td>6064 = 607C</td> </tr> <tr> <td>0</td> <td>1</td> <td>607D-02-607C</td> <td>607D-01-607C</td> <td>6064 = -607C</td> </tr> <tr> <td>1</td> <td>-</td> <td>607D-02</td> <td>607D-01</td> <td>6064 = 0</td> </tr> </tbody> </table> Bit4: Deal with Overtravel between the highspeed and lowspeed during homing process 0: Homing process error (set 6041h bit13=1); 1: As normal, continue homing process			Bit2	Bit3	Positive limit position	Negative limit position	Feedback after the homing process	0	0	607D-02+607C	607D-01+607C	6064 = 607C	0	1	607D-02-607C	607D-01-607C	6064 = -607C	1	-	607D-02	607D-01	6064 = 0
Bit2	Bit3	Positive limit position	Negative limit position	Feedback after the homing process																							
0	0	607D-02+607C	607D-01+607C	6064 = 607C																							
0	1	607D-02-607C	607D-01-607C	6064 = -607C																							
1	-	607D-02	607D-01	6064 = 0																							
5400	01	Set synchronization cycle minimum value	us	250	125	1000																					
5400	02	Set synchronization cycle maximum value	us	10000	4000	20000																					
5500	01	Absolute encoder multiturn number	r	-	-	-	-																				
	02	Encoder single turn position	Pulse	-	-	-	-																				
	03	Encoder feedback position 32 bit low	Pulse	-	-	-	-																				
	04	Encoder feedback position 32 bit high	Pulse	-	-	-	-																				
	05	The actual mechanical position 32 bit low	Unit	-	-	-	-																				
	06	The actual mechanical position 32 bit high	Unit	-	-	-	-																				

	07	Number of encoder communication exceptions		-	-	-	-
5501	01	Motor Speed	r/min	-	-	-	-
	02	Speed of position command	r/min	-	-	-	-
	03	Speed command	r/min	-	-	-	-
	04	Actual torque	0.1%	-	-	-	-
	05	Torque command	0.1%	-	-	-	-
	06	Relative position error	Pulse	-	-	-	-
	07	Internal position command	Pulse	-	-	-	-
	08	Overload ratio	0.1%	-	-	-	-
	09	Discharge load rate	0.1%	-	-	-	-
	0A	Inertia ratio	%	-	-	-	-
	0B	Actual positive torque limit value	0.1%	-	-	-	-
	0C	Actual negative torque limit value	0.1%	-	-	-	-
	0D	U phase current detect value	0.1%	-	-	-	-
	0E	W phase current detect value	0.1%	-	-	-	-
5502	01	SI input signal	-	-	-	-	-
	02	SO output signal	-	-	-	-	-
	03	Reserved	-	-	-	-	-
	04	Reserved	-	-	-	-	-
	05	Bus voltage	V	-	-	-	-
	06	Temperature	°C	-	-	-	-
	07	Power on time	S	-	-	-	-

5.1.3 Motion parameter starting with object dictionary 6000

Index	Sub-index	Name	Unit	Default	Min	Max	Mode
6007	0	Disconnect selection code (communication power supply, etc.)	-				
603F	0	Error code	-	-	-	-	ALL
6040	0	Control word	-	-	-	-	ALL
6041	0	Status word	-	-	-	-	ALL
605A	0	Quick stop option code	-	6	0	7	ALL
605B	0	Shutdowncode	-	0	0	1	ALL
605C	0	Disableoperation code	-	0	0	1	ALL
605D	0	Halt option code	-	1	1	4	ALL
605E	0	Alarm stop code	-	0	0	2	ALL
6060	0	Operation mode	-	8	1	11	ALL
6061	0	Displayed operation mode	-	-	-	-	ALL
6062	0	Position demand value	Command unit	-	-	-	csp/pp/hm
6063	0	Actual internal position value	Encoder	-	-	-	ALL

			unit				
6064	0	Actual feedback position value	Command unit	-	-	-	ALL
6065	0	Follow error window	Command unit	10000	0	2147483647	pp
6066	0	Follow error detection time	ms	10	0	65535	pp
606B	0	Internal command speed	Command unit	-	-	-	csv/pv
606C	0	Actual feedback speed value	Command unit	-	-	-	ALL
606D	0	Speed window	Command unit /s	20000	0	65536	CSV/pv
606E	0	Speed window detection tim	ms	0	0	65536	CSV/pv
6071	0	Target torque	0.001	0	-32768	32767	cst/pt
6072	0	Max torque	0.001	3000	0	65535	ALL
6073	0	Max current	0.001	-	-	-	ALL
6074	0	Internal torque command	0.001	-	-	-	ALL
6075	0	Rated current	mA	-	-	-	ALL
6076	0	Rated torque	mN.M				
6077	0	Actural torque	0.1%	-	-	-	ALL
6079	0	Bus voltage	mV	-	-	-	ALL
607A	0	Target position	Command unit	0	-2147483648	2147483647	csp/pp
607C	0	Homing position offset	Command unit	0	-2147483648	2147483647	ALL
607D	1	Minimum soft limit	Command unit	0	-2147483648	2147483647	csp/pp
	2	Maximum soft limit	Command unit	0	-2147483648	2147483647	csp/pp
607E	0	Motor rotation direction	-	0	0	255	ALL
607F	0	Maximum protocol speed (Restricted by 6080)	Command unit /s				
6080	0	Maximum motor speed	r/min	5000	0	6000	ALL
6081	0	protocol speed (Restricted by 607F)	Command unit /s	10000	0	2147483647	pp
6083	0	Profile acceleration	Command unit /s/s	10000	1	2147483647	pp/pv/
6084	0	Profile deceleration	Command unit /s/s	10000	1	2147483647	pp/pv
6085	0	Quick stop deceleration	Command unit /s/s	10000000	1	2147483647	csp/csv/pp/pv/hm
6087	0	Torque change rate	0.001/s	100	1	2147483647	pt
608F	1	Encoder resolution	Encoder unit	-	-	-	ALL
	2	Motor turns	-				
6091	1	Electron gear molecule	-	1	1	2147483647	ALL
	2	Electronic gear denominator	-	1	1	2147483647	ALL
6092	1	Number of pulses per rotation	Command unit	10000	1	2147483647	ALL

	2	Number of physical axis turns	-				
6098	0	Homing method	-	19	-6	37	hm
6099	1	High speed of homing	Command unit /s	10000	0	2147483647	hm
	2	Low speed of homing	Command unit /s	5000	0	2147483647	hm
609A	0	Homing acceleration	Command unit /s/s	10000	0	2147483647	hm
60B0	0	Position feedforward	Command unit	0	-2147483648	2147483647	csp
60B1	0	Velocity feedforward(Restricted by 6080)	Command unit /s	0	-2147483648	2147483647	csp/csv/pp/pv/hm
60B2	0	Torque feedforward	0.001	0	-32768	32767	ALL
60B8	0	Touch probe control word	-	0	0	65535	ALL
60B9	0	Touch probe statue word	-	-	-	-	ALL
60BA	0	Touch probe 1 rising edge capture position	Command unit	-	-	-	ALL
60BB	0	Touch probe 1 falling edge capture position	Command unit	-	-	-	ALL
60BC	0	Touch probe 2 rising edge capture position	Command unit	-	-	-	ALL
60BD	0	Touch probe 2 falling edge capture position	Command unit	-	-	-	ALL
60C2	1	Interpolation period	-	2	0	255	csp/csv/cst
	2	Interpolation time index	-	-3	-128	127	csp/csv/cst
60C5	0	Protocol maximum acceleration	Command unit /s/s	100000000	1	2147483647	ALL
60C6	0	Protocol maximum deceleration	Command unit /s/s	100000000	1	2147483647	ALL
60D5	0	Touch probe 1 rising edge counter	-	-	-	-	ALL
60D6	0	Touch probe 1 falling edge counter	-	-	-	-	ALL
60D7	0	Touch probe 2 rising edge counter	-	-	-	-	ALL
60D8	0	Touch probe 2 falling edge counter	-	-	-	-	ALL
60E0	0	Positive torque limit	0.001	3000	0	65535	ALL
60E1	0	Negative torque limit	0.001	3000	0	65535	ALL
60F4	0	Actual following error	Command unit	-	-	-	csp/pp/hm
60FA	0	Speed of position loop	Command unit /s	-	-	-	csp/pp/hm
60FC	0	Internal command position	Encoder unit	-	-	-	csp/pp/hm
60FD	0	Status of input	-	-	-	-	ALL
60FE	1	Output valid	-	-	-	-	ALL
	2	Output enable	-	-	-	-	ALL
60FF	0	Target speed (Restricted by	Command	0	-214748	2147483	csv/pv

		6080)	unit /s		3648	647	
6502	0	Supported operation mode	-	-	-	-	ALL

5.2 Parameter Function

5.2.1 【Class 0】 Basic Setting

Pr0.00	Name	Mode loop gain			Mode							F										
	Range	0~2000	Unit	0.1Hz	Default	0	Index	2000h														
Set up the bandwidth of MFC , it is similar to the response bandwidth																						
<table border="1"> <thead> <tr> <th>Setup value</th> <th>Meaning</th> </tr> </thead> <tbody> <tr> <td>0</td> <td>Disable the function.</td> </tr> <tr> <td>1</td> <td>Enable the function , set the bandwidth automatically , recommended for most application .</td> </tr> <tr> <td>2-10</td> <td>Forbidden and reserved .</td> </tr> <tr> <td>11-20000</td> <td>Set the bandwidth manually , 1.1Hz – 2000Hz</td> </tr> </tbody> </table>													Setup value	Meaning	0	Disable the function.	1	Enable the function , set the bandwidth automatically , recommended for most application .	2-10	Forbidden and reserved .	11-20000	Set the bandwidth manually , 1.1Hz – 2000Hz
Setup value	Meaning																					
0	Disable the function.																					
1	Enable the function , set the bandwidth automatically , recommended for most application .																					
2-10	Forbidden and reserved .																					
11-20000	Set the bandwidth manually , 1.1Hz – 2000Hz																					
MFC is used to enhance the performance of dynamic tracing for input command , make positioning faster , cut down the tracking error , run more smooth and steady . It is very useful for multi-axis synchronous movement and interpolation, the performance will be better.																						
The main way to use this function : <ol style="list-style-type: none"> Choose the right control mode : Pr001 = 0 Set up the inertia of ratio : Pr004 Set up the rigidity : Pr003 Set up the Pr000 : <ol style="list-style-type: none"> If no multi-axis synchronous movement , set Pr000 as 1 or more than 10 ; If multi-axis synchronous movement needed , set Pr000 as the same for all the axes . If Pr000 is more than 10 , start with 100 , or 150 , 200 , 250 , 																						
Caution: <ol style="list-style-type: none"> Set up the right control mode , the right inertia of ratio and rigidity firstly . Don't change the value of Pr000 when the motor is running , otherwise vibration occurs Set up a small value from the beginning if using it in manual mode , smaller value means running more smooth and steady , while bigger one means faster positioning																						

Pr0.01	Name	Control Mode Setup			Mode							F															
	Range	0~9	Unit	—	Default	9	Index	2001h																			
Set using control mode:																											
<table border="1"> <thead> <tr> <th>Setup value</th> <th>Content</th> <th>Details</th> </tr> </thead> <tbody> <tr> <td>0</td> <td>Position</td> <td></td> </tr> <tr> <td>1</td> <td>Velocity</td> <td></td> </tr> <tr> <td>2~8</td> <td>Reserved</td> <td>-</td> </tr> <tr> <td>9</td> <td>EtherCAT mode</td> <td>PP/PV/PT/HM/CSP/CSV/CST</td> </tr> </tbody> </table>													Setup value	Content	Details	0	Position		1	Velocity		2~8	Reserved	-	9	EtherCAT mode	PP/PV/PT/HM/CSP/CSV/CST
Setup value	Content	Details																									
0	Position																										
1	Velocity																										
2~8	Reserved	-																									
9	EtherCAT mode	PP/PV/PT/HM/CSP/CSV/CST																									
Note: valid after restart power supply.																											

Pr0.02	Name	Real-time Auto-gain Tuning			Mode							F
	Range	0~2	Unit	—	Default	0	Index	2002h				

You can set up the action mode of the real-time auto-gain tuning.

Setup value	mode	Varying degree of load inertia in motion
0	invalid	Real-time auto-gain tuning function is disabled.
1	standard	Basic mode. do not use unbalanced load, friction compensation or gain switching. It is usually for interpolation movement.
2	positioning	Main application is positioning. it is recommended to use this mode on equipment without unbalanced horizontal axis, ball screw driving equipment with low friction, etc. it is usually for point-to-point movement .

Caution: If pr0.02=1 or 2 , you can't modify the values of Pr1.01 – Pr1.13, the values of them depend on the real-time auto-gain tuning ,all of them are set by the driver itself.

Pr0.03	Name	Selection of machine stiffness at real-time auto-gain tuning			Mode										F
	Range	50 ~ 81	Unit	—	Default	70	Index				2003h				

You can set up response while the real-time auto-gain tuning is valid.

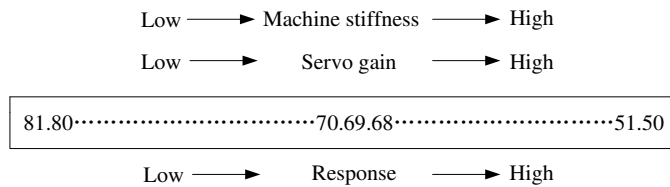

Notice: Lower the setup value, higher the velocity response and servo stiffness will be obtained. However, when decreasing the value, check the resulting operation to avoid oscillation or vibration. Control gain is updated while the motor is stopped. If the motor can't be stopped due to excessively low gain or continuous application of one-way direction command ,any change made to Pr0.03 is not used for update. If the changed stiffness setting is made valid after the motor stopped, abnormal sound or oscillation will be generated. To prevent this problem, stop the motor after changing the stiffness setting and check that the changed setting is enabled.

Pr0.04	Name	Inertia ratio			Mode										F
	Range	0~10000	Unit	%	Default	250	Index				2004h				

You can set up the ratio of the load inertia against the rotor(of the motor)inertia.

$$\text{Pr0.04} = (\text{load inertia} / \text{rotate inertia}) \times 100\%$$

Notice:

If the inertia ratio is correctly set, the setup unit of Pr1.01 and Pr1.06 becomes (Hz). When the inertia ratio of Pr0.04 is larger than the actual value, the setup unit of the velocity loop gain becomes larger, and when the inertia ratio of Pr0.04 is smaller than the actual value, the setup unit of the velocity loop gain becomes smaller.

Pr0.07	Name	Touch probe polarity setting			Mode										F
	Range	0 ~ 3	Unit	—	Default	3	Index				2007h				

Setup value	Details
0	Touch probe 1 and touch probe 2 have reversed polarity
1	Touch probe 2 reversed polarity only
2	Touch probe 1 reversed polarity only
3	Touch probe 1 and touch probe 2 do not have reversed polarity

Note: valid after restart the power.

Pr0.13	Name	1st Torque Limit			Mode						F
	Range	0~500	Unit	%	Default	300	Index	2013h			
You can set up the limit value of the motor output torque, as motor rate current %, the value can't exceed the maximum of output current. Compared with the maximum torque 6072, the actual torque limit value is smaller one.											

Pr0.14	Name	Position Deviation Excess Setup			Mode	PP			HM	CSP	
	Range	0~500	Unit	0.1rev	Default	200	Index	2014h			
Set excess range of positional deviation by the command unit(default).Setting the value too small will cause Err180 (position deviation excess detection)											

Pr0.15	Name	Absolute Encoder Setup			Mode	PP			HM	CSP	
	Range	0~15	Unit	-	Default	0	Index	2015h			
How to use: 0: Incremental position mode: The encoder is used as a incremental encoder, and the position retentive at power failure is not supported. 1: Absolute position linear mode: The encoder is used as an absolute encoder, and the position retentive at power failure is supported.. It is applicable to the scenario where the travel range of device load is fixed and the encoder multi-turn data dose not overflow. 2: Absolute position rotation mode: The encoder is used as an absolute encoder, and the position retentive at power failure is supported.. It is mainly applicable to the scenario where the load travel range is not limited and the number of motor single-direction revolution is less than 0~(Pr6.63+1) 5: Clean multi-turn alarm, and open multi-turn absolute function. It will become 1 when normal clearance, if it's still 5 after 3seconds, please deal with according to 153 alarm processing. 9: Clear multi-turn position and reset multi-turn alarm, open multi-turn absolute function. It will become 1 when normal clearance, if it's still 9 after 3seconds, please deal with according to 153 alarm processing. Please remember to do mechanical homing. Notes: Set to 9 after homing process finished and servo disabled.,valid after restart power-supply											

Pr0.16	Name	External regenerative resistance			Mode						F
	Range	40~500	Unit	Ohm	Default	100	Index	2016h			
Set Pr.0.16 and Pr.0.17 to confirm the threshold value of the discharge loop to give alarm for over current.											

Pr0.17	Name	External regenerative resistor power value			Mode						F
---------------	------	--	--	--	------	--	--	--	--	--	----------

	Range	20~5000	Unit	W	Default	20	Index	2017h
Set Pr.0.16 and Pr.0.17 to confirm the threshold value of the discharge loop to give alarm for over current.								

Pr0.23 *	Name	EtherCAT slave ID		Mode					F
	Range	0~32767	Unit	—	Default	2	Index	2023h	
Setup the ID number of the slave station.									
Pr0.24 *	Name	Source of the slave ID		Mode					F
	Range	0~7	Unit	—	Default	0	Index	2024h	
1: The slave ID = Pr0.23									

Pr0.25	Name	Synchronous compensation time 1		Mode				CSP	
	Range	1~100	Unit	0.1us	Default	10	Index	2025h	
Synchronous jitter compensation range, used in poor synchronization of the master station. Note: Valid after restart power.									

Pr0.26	Name	Synchronous compensation time 2		Mode				CSP	
	Range	1~2000	Unit	0.1us	Default	50	Index	2026h	
Synchronous jitter compensation range, used in poor synchronization of the master station. Note: Valid after restart power.									

5.2.2 【Class 1】 Gain Adjust

Pr1.00	Name	1st gain of position loop		Mode	PP		HM	CSP	
	Range	0~30000	Unit	0.1/s	Default	320	Index	2100h	
You can determine the response of the positional control system. Higher the gain of position loop you set, faster the positioning time you can obtain. Note that too high setup may cause oscillation.									

Pr1.01	Name	1st gain of velocity loop		Mode					F
	Range	1~32767	Unit	0.1Hz	Default	180	Index	2101h	
You can determine the response of the velocity loop. In order to increase the response of overall servo system by setting high position loop gain, you need higher setup of this velocity loop gain as well. However, too high setup may cause oscillation.									

Pr1.02	Name	1st Time Constant of Velocity Loop Integration		Mode					F
	Range	1~10000	Unit	0.1ms	Default	310	Index	2102h	

You can set up the integration time constant of velocity loop, Smaller the set up, faster you can dog-in deviation at stall to 0.The integration will be maintained by setting to"9999".The integration effect will be lost by setting to"10000".

Pr1.03	Name	1st Filter of Velocity Detection			Mode						F																																																																				
	Range	0~31	Unit	—	Default	15	Index		2103h																																																																						
<p>You can set up the time constant of the low pass filter (LPF) after the speed detection, in 32 steps (0 to 31).Higher the setup, larger the time constant you can obtain so that you can decrease the motor noise, however, response becomes slow.</p> <p>You can set the filter parameters through the loop gain, referring to the following table:</p> <table border="1" style="margin-left: 40px; border-collapse: collapse; width: 80%;"> <thead> <tr style="background-color: #00AEEF; color: white;"> <th>Setup Value</th> <th>Speed Detection Filter Cut-off Frequency(Hz)</th> <th>Setup Value</th> <th>Speed Detection Filter Cut-off Frequency(Hz)</th> </tr> </thead> <tbody> <tr><td>0</td><td>2500</td><td>16</td><td>750</td></tr> <tr><td>1</td><td>2250</td><td>17</td><td>700</td></tr> <tr><td>2</td><td>2100</td><td>18</td><td>650</td></tr> <tr><td>3</td><td>2000</td><td>19</td><td>600</td></tr> <tr><td>4</td><td>1800</td><td>20</td><td>550</td></tr> <tr><td>5</td><td>1600</td><td>21</td><td>500</td></tr> <tr><td>6</td><td>1500</td><td>22</td><td>450</td></tr> <tr><td>7</td><td>1400</td><td>23</td><td>400</td></tr> <tr><td>8</td><td>1300</td><td>24</td><td>350</td></tr> <tr><td>9</td><td>1200</td><td>25</td><td>300</td></tr> <tr><td>10</td><td>1100</td><td>26</td><td>250</td></tr> <tr><td>11</td><td>1000</td><td>27</td><td>200</td></tr> <tr><td>12</td><td>950</td><td>28</td><td>175</td></tr> <tr><td>13</td><td>900</td><td>29</td><td>150</td></tr> <tr><td>14</td><td>850</td><td>30</td><td>125</td></tr> <tr><td>15</td><td>800</td><td>31</td><td>100</td></tr> </tbody> </table>												Setup Value	Speed Detection Filter Cut-off Frequency(Hz)	Setup Value	Speed Detection Filter Cut-off Frequency(Hz)	0	2500	16	750	1	2250	17	700	2	2100	18	650	3	2000	19	600	4	1800	20	550	5	1600	21	500	6	1500	22	450	7	1400	23	400	8	1300	24	350	9	1200	25	300	10	1100	26	250	11	1000	27	200	12	950	28	175	13	900	29	150	14	850	30	125	15	800	31	100
Setup Value	Speed Detection Filter Cut-off Frequency(Hz)	Setup Value	Speed Detection Filter Cut-off Frequency(Hz)																																																																												
0	2500	16	750																																																																												
1	2250	17	700																																																																												
2	2100	18	650																																																																												
3	2000	19	600																																																																												
4	1800	20	550																																																																												
5	1600	21	500																																																																												
6	1500	22	450																																																																												
7	1400	23	400																																																																												
8	1300	24	350																																																																												
9	1200	25	300																																																																												
10	1100	26	250																																																																												
11	1000	27	200																																																																												
12	950	28	175																																																																												
13	900	29	150																																																																												
14	850	30	125																																																																												
15	800	31	100																																																																												

Pr1.04	Name	1st torque filter			Mode						F
	Range	0~2500	Unit	0.01ms	Default	126	Index		2104h		
<p>Set the time constant of the first order hysteresis filter for the insertion of torque instruction. Vibration due to torsional resonance can be controlled.</p>											

Pr1.05	Name	2nd gain of position loop			Mode	PP			HM	CSP		
	Range	0~30000	Unit	0.1/s	Default	380	Index		2105h			

Pr1.06	Name	2nd gain of velocity loop			Mode						F
	Range	1~32767	Unit	0.1Hz	Default	180	Index		2106h		

Pr1.07	Name	2nd Time Constant of Velocity Loop Integration			Mode						F
	Range	1~10000	Unit	0.1ms	Default	10000	Index		2107h		

Pr1.08	Name	2nd Filter of Velocity Detection			Mode						F
	Range	0~31	Unit	—	Default	15	Index		2108h		

Pr1.09	Name	2nd Time Constant of torque filter			Mode							F
	Range	0~2500	Unit	0.01ms	Default	126	Index		2109h			
Position loop, velocity loop, velocity detection filter, torque command filter have their 2 pairs of gain or time constant(1st and 2nd).												

Pr1.10	Name	Velocity feed forward gain			Mode	PP			HM	CSP		
	Range	0~1000	Unit	0.10%	Default	300	Index		2110h			
Multiply the velocity control command calculated according to the internal positional command by the ratio of this parameter and add the result to the speed command resulting from the positional control process.												

Pr1.11	Name	Velocity feed forward filter			Mode	PP			HM	CSP		
	Range	0~6400	Unit	0.01ms	Default	50	Index		2111h			
Set the time constant of 1st delay filter which affects the input of speed feed forward. (usage example of velocity feed forward) The velocity feed forward will become effective as the velocity feed forward gain is gradually increased with the speed feed forward filter set at approx.50 (0.5ms). The positional deviation during operation at a constant speed is reduced as shown in the equation below in proportion to the value of velocity feed forward gain. Position deviation [unit of command]=command speed [unit of command /s]/position loop gain[1/s]×(100-speed feed forward gain[%])/100												

Pr1.12	Name	Torque feed forward gain			Mode	PP	PV	HM	CSP	CSV		
	Range	0~1000	Unit	0.1%	Default	0	Index		2112h			
<ul style="list-style-type: none"> ● Multiply the torque control command calculated according to the velocity control command by the ratio of this parameter and add the result to the torque command resulting from the velocity control process. ● To use torque feed forward, correctly set ratio of inertia. Set the inertia ratio that can be calculated from the machine specification to Pr0.04 inertia ratio. ● Positional deviation at a constant acceleration/deceleration can be minimized close to 0 by increasing the torque forward gain .this means that positional deviation can be maintained at near 0 over entire operation range while driving in trapezoidal speed pattern under ideal condition where disturbance torque is not active. 												

Pr1.13	Name	Torque feed forward filter			Mode	PP	PV	HM	CSP	CSV		
	Range	0~6400	Unit	0.01ms	Default	0	Index		2113h			
Set up the time constant of 1st delay filter which affects the input of torque feed forward. zero positional deviation is impossible in actual situation because of disturbance torque. as with the velocity feed forward, large torque feed forward filter time constant decreases the operating noise but increases positional deviation at acceleration change point.												

Pr1.15	Name	Mode of position control switching			Mode							F						
	Range	0~10	Unit	—	Default	0	Index		2115h									
<table border="1" style="width: 100%; border-collapse: collapse;"> <thead> <tr style="background-color: #008000; color: white;"> <th style="width: 15%;">Setup value</th> <th style="width: 20%;">Switching condition</th> <th style="width: 65%;">Gain switching condition</th> </tr> </thead> <tbody> <tr> <td style="text-align: center;">0</td> <td>Fixed to 1st gain</td> <td>Fixed to the 1st gain (Pr1.00-Pr1.04)</td> </tr> </tbody> </table>													Setup value	Switching condition	Gain switching condition	0	Fixed to 1st gain	Fixed to the 1st gain (Pr1.00-Pr1.04)
Setup value	Switching condition	Gain switching condition																
0	Fixed to 1st gain	Fixed to the 1st gain (Pr1.00-Pr1.04)																

1	Fixed to 2nd gain	Fixed to the 2nd gain (Pr1.05-Pr1.09)
2	Reserved	
3	Torque command is large	<ul style="list-style-type: none"> ● Shift to the 2nd gain when the absolute value of the torque command exceeded (level + hysteresis)[%]previously with the 1st gain. ● Return to the 1st gain when the absolute value of the torque command was kept below (level + hysteresis) [%]previously during delay time with the 2nd gain.
4	Reserved	Reserved
5	Speed command is large	<ul style="list-style-type: none"> ● Valid for position and speed controls. ● Shift to the 2nd gain when the absolute value of the speed command exceeded (level + hysteresis)[r/min]previously with the 1st gain. ● Return to the 1st gain when the absolute value of the speed command was kept below (level + hysteresis) [r/min] previously during delay time with the 2nd gain.
6	Position deviation is large	<ul style="list-style-type: none"> ● Valid for position control. ● Shift to the 2nd gain when the absolute value of the positional deviation exceeded (level + hysteresis)[pulse] previously with the 1st gain. ● Return to the 1st gain when the absolute value of the positional deviation was kept below (level + hysteresis)[r/min]previously during delay time with the 2nd gain. <p>◇ Unit of level and hysteresis [pulse] is set as the encoder resolution for positional control.</p>
7	position command exists	<ul style="list-style-type: none"> ● Valid for position control. ● Shift to the 2nd gain when the positional command was not 0 previously with the 1st gain. ● Return to the 1st gain when the positional command was kept 0 previously during delay time with the 2nd gain.
8	Not in positioning complete	<ul style="list-style-type: none"> ● Valid for position control. ● Shift to the 2nd gain when the positioning was not completed previously with the 1st gain. ● Return to the 1st gain when the positioning was kept in completed condition previously during delay time with the 2nd gain.
9	Actual speed is large	<ul style="list-style-type: none"> ● Valid for position control. ● Shift to the 2nd gain when the absolute value of the actual speed exceeded (level + hysteresis) (r/min) previously with the 1st gain. ● Return to the 1st gain when the absolute value of the actual speed was kept below (level - hysteresis) (r/min) previously during delay time with the 2nd gain.
10	Have position command +actual speed	<ul style="list-style-type: none"> ● Valid for position control. ● Shift to the 2nd gain when the positional command was not 0 previously with the 1st gain. ● Return to the 1st gain when the positional command was kept at 0 during the delay time and the absolute value of actual speed was kept below (level - hysteresis) (r/min) previously with the 2nd gain.

In position control mode, setup Pr1.15=3,5,6,9,10;

In speed control mode, setup Pr1.15=3,5,9;

Pr1.17	Name	Level of position control switching			Mode							F
	Range	0~20000	Unit	Mode dependen	Default	50	Index		2117h			
Unit of setting varies with switching mode. switching condition: position :encoder pulse number ; speed : r/min ; torque : % . Notice: set the level equal to or higher than the hysteresis.												

Pr1.18	Name	Hysteresis at position control switching			Mode						F
	Range	0~20000	Unit	Mode dependent	Default	33	Index		2118h		

Combining Pr1.17(control switching level)setup

Notice: when level < hysteresis, the hysteresis is internally adjusted so that it is equal to level.

Pr1.19	Name	position gain switching time			Mode						F
	Range	0~10000	Unit	0.1ms	Default	33	Index		2119h		

For position controlling: if the difference between 1st gain and 2nd gain is large, the increasing rate of position loop gain can be limited by this parameter.

<Position gain switching time>

Notice: when using position control, position loop gain rapidly changes, causing torque change and vibration. By adjusting Pr1.19 position gain switching time, increasing rate of the position loop gain can be decreased and variation level can be reduced.

Example: 1st (pr1.00) <-> 2nd (Pr1.05)

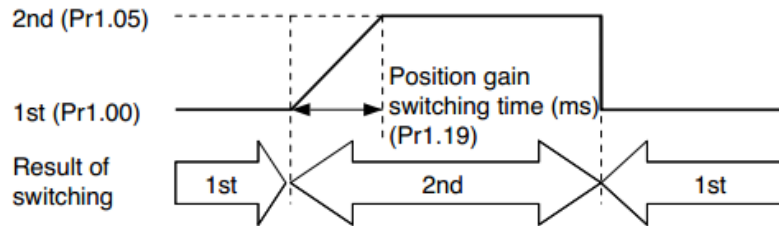

Pr1.37	Name	Special register			Mode						F
	Range	0~0xFFFF	Unit	-	Default	0	Index		2137h		

Bit	Pr1.37	Details	Bit	Pr1.37	Details
0	0x0001	shield the speed out of control alarm (1A1)	7	0x0080	shield the multi-turn data overflow alarm (157)
1	0x0002	shield the over-speed alarm (1A0)	8	0x0100	Turn on torque saturation alarm (105)
2	0x0004	Enable virtual IO in homing mode	9	0x0200	Reserved
3	0x0008	Reserved	10	0x0400	shield UVW wire break alarm (0A3)
4	0x0010	Reserved	11	0x0800	shield the motor vibration alarm (190)
5	0x0020	Torque limit signal output threshold selection in torque mode: shield 6071	12	Reserved	
6	0x0040	shield the position error over-large error (180)	13	Reserved	

5.2.3 【Class 2】Vibration Suppression

Pr2.00	Name	Adaptive filter mode setup			Mode						F															
	Range	0~4	Unit	-	Default	0	Index	2200h																		
Set up the resonance frequency to be estimated by the adaptive filter and the special the operation after estimation.																										
<table border="1"> <thead> <tr> <th>Setup value</th> <th colspan="2">content</th> </tr> </thead> <tbody> <tr> <td>0</td> <td>Adaptive filter: invalid</td> <td>Parameters related to the 3rd and 4th notch filter hold the current value.</td> </tr> <tr> <td>1</td> <td>Adaptive filter, 1 filter is valid, one time</td> <td>One adaptive filter is valid, parameters related to the 3rd notch filter will be updated based on adaptive performance. After updated, Pr2.00 returns to 0, stop self-adaptation.</td> </tr> <tr> <td>2</td> <td>Adaptive filter, 1 filter is valid, It will be valid all the time</td> <td>One adaptive filter is valid, parameters related to the 3rd notch filter will be updated all the time based on adaptive performance.</td> </tr> <tr> <td>3-4</td> <td>Not use</td> <td>Non-professional forbidden to use</td> </tr> </tbody> </table>												Setup value	content		0	Adaptive filter: invalid	Parameters related to the 3rd and 4th notch filter hold the current value.	1	Adaptive filter, 1 filter is valid, one time	One adaptive filter is valid, parameters related to the 3rd notch filter will be updated based on adaptive performance. After updated, Pr2.00 returns to 0, stop self-adaptation.	2	Adaptive filter, 1 filter is valid, It will be valid all the time	One adaptive filter is valid, parameters related to the 3rd notch filter will be updated all the time based on adaptive performance.	3-4	Not use	Non-professional forbidden to use
Setup value	content																									
0	Adaptive filter: invalid	Parameters related to the 3rd and 4th notch filter hold the current value.																								
1	Adaptive filter, 1 filter is valid, one time	One adaptive filter is valid, parameters related to the 3rd notch filter will be updated based on adaptive performance. After updated, Pr2.00 returns to 0, stop self-adaptation.																								
2	Adaptive filter, 1 filter is valid, It will be valid all the time	One adaptive filter is valid, parameters related to the 3rd notch filter will be updated all the time based on adaptive performance.																								
3-4	Not use	Non-professional forbidden to use																								

Pr2.01	Name	1st notch frequency			Mode						F
	Range	50~2000	Unit	Hz	Default	2000	Index	2201h			
Set the center frequency of the 1st notch filter Notice: the notch filter function will be invalidated by setting up this parameter to “2000”.											

Pr2.02	Name	1st notch width selection			Mode						F
	Range	0~20	Unit	-	Default	2	Index	2202h			
Set the width of notch at the center frequency of the 1st notch filter. Notice: Higher the setup, larger the notch width you can obtain. Use with default setup in normal operation.											

Pr2.03	Name	1st notch depth selection			Mode						F
	Range	0~99	Unit	-	Default	0	Index	2203h			
Set the depth of notch at the center frequency of the 1st notch filter. Notice: Higher the setup, shallower the notch depth and smaller the phase delay you can obtain.											

Pr2.04	Name	2nd notch frequency			Mode						F
	Range	50~2000	Unit	Hz	Default	2000	Index	2204h			
Set the center frequency of the 2nd notch filter Notice: the notch filter function will be invalidated by setting up this parameter to “2000”.											

Pr2.05	Name	2nd notch width selection			Mode							F
	Range	0~20	Unit	-	Default	2	Index	2205h				
Set the width of notch at the center frequency of the 2nd notch filter. Notice: Higher the setup, larger the notch width you can obtain. Use with default setup in normal operation.												

Pr2.06	Name	2nd notch depth selection			Mode							F
	Range	0~99	Unit	-	Default	0	Index	2206h				
Set the depth of notch at the center frequency of the 2nd notch filter. Notice: Higher the setup, shallower the notch depth and smaller the phase delay you can obtain.												

Pr2.07	Name	3rd notch frequency			Mode							F
	Range	50~2000	Unit	Hz	Default	2000	Index	2207h				
Set the center frequency of the 3rd notch filter Notice: the notch filter function will be invalidated by setting up this parameter to “2000”. Setup invalid after opening self-adaptation function.												

Pr2.14	Name	1st damping frequency			Mode							F
	Range	10~2000	Unit	0.1Hz	Default	0	Index	2214h				
0: close Setup damping frequency, to suppress vibration at the load edge.												

Pr2.15	Name	2nd damping frequency			Mode							F
	Range	10~2000	Unit	0.1Hz	Default	0	Index	2215h				
0: close Setup damping frequency, to suppress vibration at the load edge.												

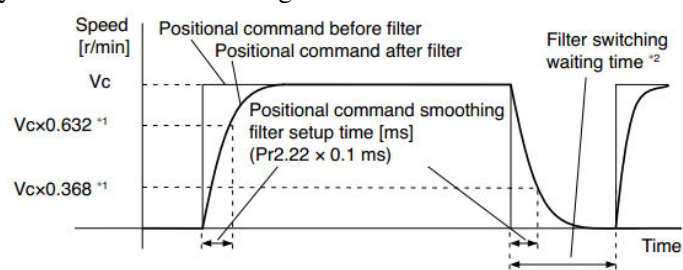
Pr2.22	Name	positional command smoothing filter			Mode	PP			H	CS		
	Range	0~32767	Unit	0.1ms	Default	0	Index	2222h				
<ul style="list-style-type: none"> ● Set up the time constant of the 1st delay filter in response to the positional command. ● When a square wave command for the target speed V_c is applied, set up the time constant of the 1st delay filter as shown in the figure below. 												
												

Pr2.23	Name	positional command FIR filter			Mode	PP		H	CS		
	Range	0~10000	Unit	0.1ms	Default	0	Index	M	P		2223h

- Set up the time constant of the 1st delay filter in response to the positional command.
- When a square wave command for the target speed V_c is applied, set up the V_c arrival time as shown in the figure below.

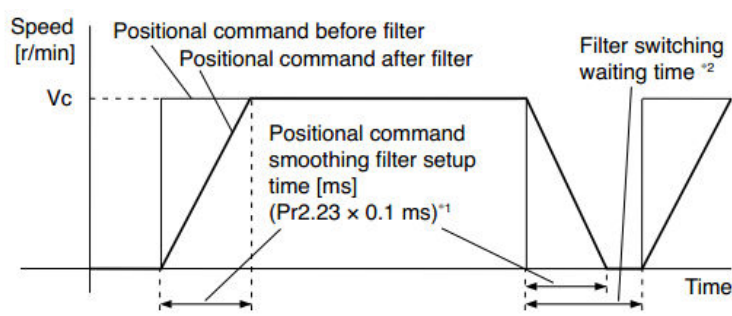

5.2.4 【Class 3】 Velocity/ Torque Control

Pr3.12	Name	time setup acceleration			Mode	PV				CSV
	Range	0~10000	Unit	Ms/ (1000RPM)	Default	100	Index			2312h
Pr3.13	Name	time setup deceleration			Mode	PV				CSV
	Range	0~10000	Unit	Ms/ (1000RPM)	Default	100	Index			2313h

Set up acceleration/deceleration processing time in response to the speed command input. Set the time required for the speed command(stepwise input)to reach 1000r/min to Pr3.12 Acceleration time setup. Also set the time required for the speed command to reach from 1000r/min to 0 r/min, to Pr3.13 Deceleration time setup.

Assuming that the target value of the speed command is V_c (r/min), the time required for acceleration/deceleration can be computed from the formula shown below.

$$\text{Acceleration time (ms)} = V_c / 1000 * \text{Pr3.12} * 1 \text{ms}$$

$$\text{Deceleration time (ms)} = V_c / 1000 * \text{Pr3.13} * 1 \text{ms}$$

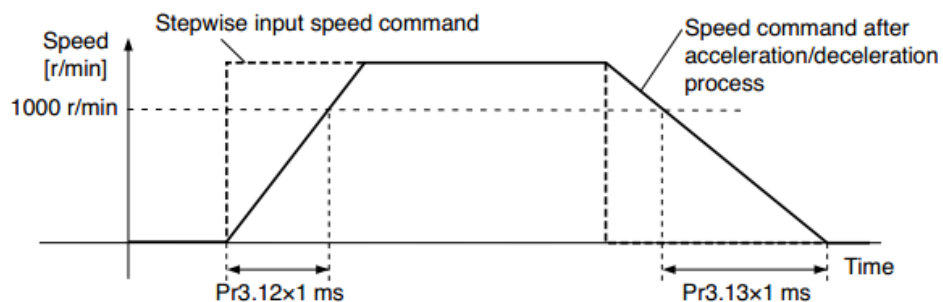

Pr3.14	Name	Sigmoid acceleration/deceleration time setup			Mode	PV				CSV
	Range	0~1000	Unit	ms	Default	0	Index			2314h

Set S-curve time for acceleration/deceleration process when the speed command is applied. According to Pr3.12 Acceleration time setup and Pr3.13 Deceleration time setup, set up sigmoid time with time width

centering the inflection point of acceleration/deceleration.

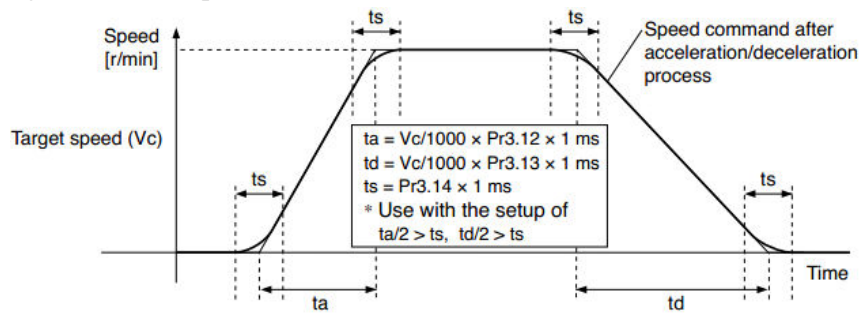

Pr3.16	Name	Speed zero-clamp level			Mode		PV			CSV
	Range	10~2000	Unit	RPM	Default	30	Index		2316h	
When speed given value under speed control mode less than zero speed clamp level setup, speed command will set to 0 strongly.										

Pr3.23	Name	Speed mode zero speed static			Mode		PV			CSV
	Range	0~32767	Unit	ms	Default	0	Index		2323h	
Prevent motion when speed mode is stationary.										

5.2.5 【Class 4】 I/F Monitor Setting

Pr4.00	Name	Input selection S11			Mode					F
	Range	0~00FFFFFFh	Unit	—	Default	0	Index		2400h	
Pr4.01	Name	Input selection S12			Mode					F
	Range	0~00FFFFFFh	Unit	—	Default	000001	Index		2401h	
Pr4.02	Name	Input selection S13			Mode					F
	Range	0~00FFFFFFh	Unit	—	Default	000002	Index		2402h	
Pr4.03	Name	Input selection S14			Mode					F
	Range	0~00FFFFFFh	Unit	—	Default	000016	Index		2403h	
Pr4.04	Name	Input selection S15			Mode					F
	Range	0~00FFFFFFh	Unit	—	Default	000007	Index		2404h	
Pr4.05	Name	Input selection S16			Mode					F
	Range	0~00FFFFFFh	Unit	—	Default	000014	Index		2405h	
Pr4.06	Name	Input selection S17			Mode					F
	Range	0~00FFFFFFh	Unit	—	Default	0	Index		2406h	
Pr4.07	Name	Input selection S18			Mode					F
	Range	0~00FFFFFFh	Unit	—	Default	0	Index		2407h	
Pr4.08	Name	Input selection S19			Mode					F
	Range	0~00FFFFFFh	Unit	—	Default	0	Index		2408h	
Pr4.09	Name	Input selection S110			Mode					F

	Range	0~00FFFFFFh	Unit	—	Default	0	Index	2409h
Pr4.44	Name	Input selection SI11			Mode			F
	Range	0~00FFFFFFh	Unit	—	Default	0	Index	2444h
Pr4.45	Name	Input selection SI12			Mode			F
	Range	0~00FFFFFFh	Unit	—	Default	0	Index	2445h
Pr4.46	Name	Input selection SI13			Mode			F
	Range	0~00FFFFFFh	Unit	—	Default	0	Index	2446h
Pr4.47	Name	Input selection SI14			Mode			F
	Range	0~00FFFFFFh	Unit	—	Default	0	Index	2447h

Set SI1 input function allocation.

This parameter use 16 binary system to set up the values,

For the function number, please refer to the following Figure.

Signal name	Symbol	Set value		0x60FD(bit)
		Normally open	Normally closed	
Invalid	—	00h	Do not setup	×
Positive direction over-travel inhibition input	POT	01h	81h	1
Negative direction over-travel inhibition input	NOT	02h	82h	0
Alarm clear input	A-CLR	04h	Do not setup	
Forced alarm input	E-STOP	14h	94h	
HOME-SWITCH	HOME-SWITCH	16h	96h	2

- Normally open contact means when input signal is on and function is triggered.
- Normally closed contact means when input signal is off and function is triggered.
- Don't setup to a value other than that specified in the table .
- Don't assign specific function to 2 or more signals. Duplicated assignment will cause Err21.0 I/F input multiple assignment error 1or Err21.1 I/F input multiple assignment error 2.
- E-STOP: Associated parameter Pr4.43

Pr4.10	Name	Output selection SO1			Mode				F
	Range	0~00FFFFFFh	Unit	—	Default	000001h	Index	2410h	
Pr4.11	Name	Output selection SO2			Mode				F
	Range	0~00FFFFFFh	Unit	—	Default	000002h	Index	2411h	
Pr4.12	Name	Output selection SO3			Mode				F
	Range	0~00FFFFFFh	Unit	—	Default	000004h	Index	2412h	
Pr4.13	Name	Output selection SO4			Mode				F
	Range	0~00FFFFFFh	Unit	—	Default	000003h	Index	2413h	
Pr4.14	Name	Output selection SO5			Mode				F
	Range	0~00FFFFFFh	Unit	—	Default	0	Index	2414h	
Pr4.15	Name	Output selection SO6			Mode				F

Range	0~00FFFFFFh	Unit	—	Default	0	Index	2415h
Assign functions to SO1 outputs. This parameter use 16 binary system do setup For the function number, please refer to the following Figure.							
Signal name		symbol		Setup value			
				Normally open		Normally closed	
Master control output		—		00h		Do not setup	
Alarm output		Alm		01h		81h	
Servo-Ready output		S-RDY		02h		82h	
Eternal brake release signal		BRK-OFF		03h		83h	
Positioning complete output		INP		04h		84h	
At-speed output		AT-SPPED		05h		85h	
Torque limit signal output		TLC		06h		86h	
Zero speed clamp detection output		ZSP		07h		87h	
Velocity coincidence output		V-COIN		08h		88h	
Positional command ON/OFF output		P-CMD		0Bh		8Bh	
Speed limit signal output		V-LIMIT		0Dh		8Dh	
Speed command ON/OFF output		V-CMD		0Fh		8Fh	
Servo enable state output		SRV-ST		12h		92h	
Homing process finish		HOME-OK		22h		A2h	
<ul style="list-style-type: none"> • Normally open: Active low • Normally closed: Active high • In EtherCAT mode, the arrival signal in pp, pv and pt mode is consistent with INP, v-coin and TLC signals respectively, and is reflected in bit24 in 60FD • Don't setup to a value other than that specified in the table . • Pr4.10~Pr4.15 correspond to SO1~SO6 respectively. When the parameters are set to all 0, it is the master control output. Bit16 ~bit21 of the object dictionary 0x60FE sub-index 01 corresponds to SO1~SO6 respectively 							

Pr4.31	Name	Positioning complete range			Mode	PP		H	M	CSP		
	Range	0~10000	Unit		Default	10	Index	2431h				
Set up the timing of positional deviation at which the positioning complete signal (INP1) is output.												

Pr4.32	Name	Positioning complete range			Mode	PP		H	M	CSP		
	Range	0~4	Unit	-	Default	0	Index	2432h				

Select the condition to output the positioning complete signal (INP1).

Setup value	Action of positioning complete signal
0	The signal will turn on when the positional deviation is smaller than Pr4.31 [positioning complete range].
1	The signal will turn on when there is no position command and position deviation is smaller than Pr4.31 [positioning complete range].
2	The signal will turn on when there is no position command, the zero-speed detection signal is ON and the positional deviation is smaller than Pr4.31 [positioning complete range].
3	The signal will turn on when there is no position command and the positional deviation is smaller than Pr4.31 [positioning complete range]. Then holds "ON" states until the next position command is entered. Subsequently, ON state is maintained until Pr4.33 INP hold time has elapsed. After the hold time, INP output will be turned ON/OFF according to the coming positional command or condition of the positional deviation.
4	When there is no command, the position determination starts after the delay time set by Pr4.33 The signal will turn on when there is no position command and positional deviation is smaller than Pr4.31 [positioning complete range]

Pr4.33	Name	INP hold time			Mode	PP			H	M	CSP		
	Range	0~15000	Unit	ms	Default	0	Index					2433h	

Set up the hold time when Pr 4.32 positioning complete output setup=3.

Setup value	State of Positioning complete signal
0	The hold time is maintained definitely, keeping ON state until next positional command is received.
1-15000	ON state is maintained for setup time (ms)but switched to OFF state as the positional command is received during hold time.

Pr4.34	Name	Zero-speed			Mode							F
	Range	10~2000	Unit	RPM	Default	50	Index					2434h

The rotation speed (RPM) was used to set the output timing sequence of the zero speed detection output signal (ZSP). When the motor speed is lower than the setting speed of this parameter, zero speed detection signal (ZSP) is output.

You can set up the timing to feed out the zero-speed detection output signal(ZSP or TCL) in rotate speed (r/min).
The zero-speed detection signal(ZSP) will be fed out when the motor speed falls below the setup of this parameter, Pr4.34

- the setup of pr4.34 is valid for both positive and negative direction regardless of the motor rotating direction.
- There is hysteresis of 10[r/min].

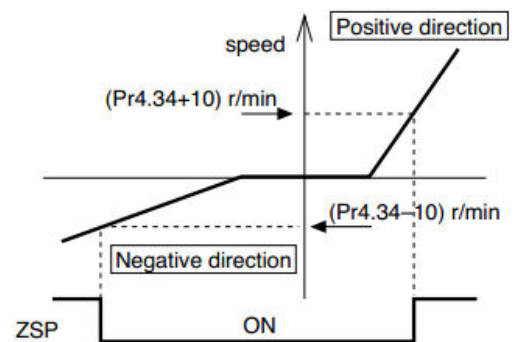

Pr4.35	Name	Speed coincidence range			Mode	PV				CSV
	Range	10~2000	Unit	RPM	Default	50	Index			2435h

Set the speed coincidence (V-COIN) output detection timing.
Output the speed coincidence (V-COIN) when the difference between the speed command and the motor speed is equal to or smaller than the speed specified by this parameter.

Because the speed coincidence detection is associated with 10 r/min hysteresis, actual detection range is as shown below.

Speed coincidence output OFF -> ON timing (Pr4.35 -10) r/min

Speed coincidence output ON -> OFF timing (Pr4.35 +10) r/min

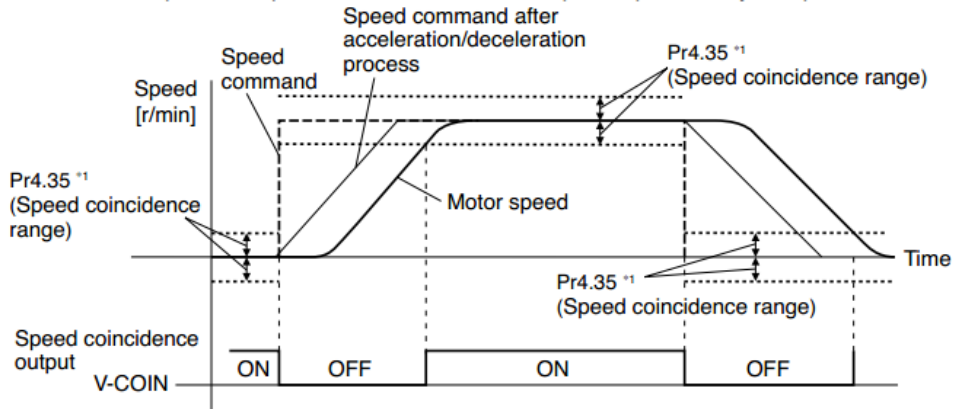

Pr4.36	Name	At-speed(Speed arrival)			Mode		PV				CSV
	Range	10~2000	Unit	RPM	Default	1000	Index				2436h

Set the detection timing of the speed arrival output (AT-SPEED).
When the motor speed exceeds this setup value, the speed arrive output (AT-SPEED) is output.
Detection is associated with 10r/min hysteresis .

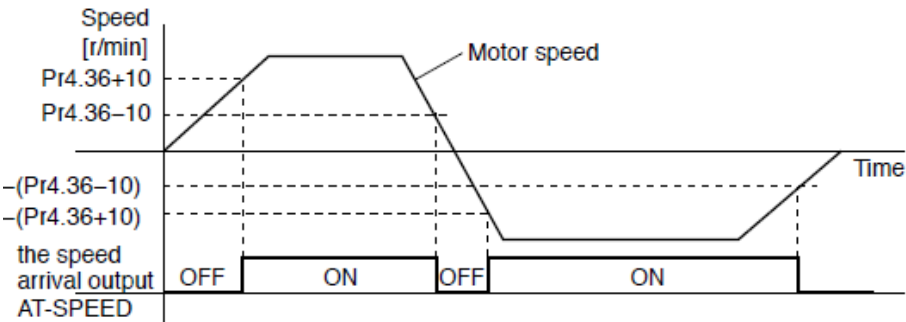

Pr4.37	Name	Mechanical brake action at stopping			Mode						F
	Range	0~10000	Unit	1ms	Default	0	Index				2437h

Motor brake delay time setup, mainly used to prevent servo on “galloping “phenomenon.
Set up the time from when the brake release signal(BRK-OFF) turns off to when the motor is de-energized (servo-free),when the motor turns to servo-off while the motor is at stall

- Set up to prevent a micro-travel/drop of the motor (work) due to the action delay time(tb) of the brake.
- After setting up $Pr4.37 \geq tb$, then compose the sequence

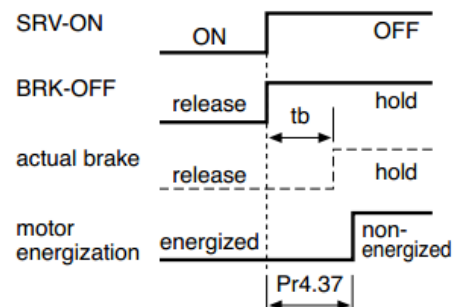

so as the driver turns to servo-off after the brake is actually activated.

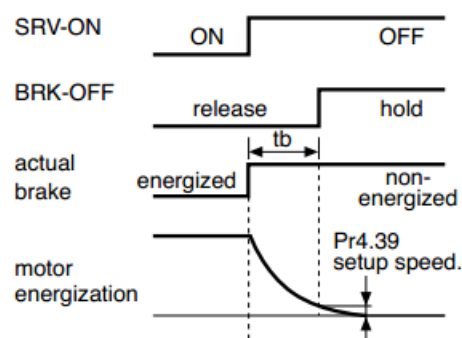
Pr4.38	Name	Mechanical brake action at running setup			Mode							F
	Range	0~10000	Unit	1ms	Default	0	Index	2438h				
<p>Mechanical brake start delay time setup, mainly used to prevent servo off “galloping” phenomenon. Set up time from when detecting the off of servo-on input signal(SRV-ON)is to when external brake release signal(BRK-OFF)turns off, while the motor turns to servo off during the motor in motion.</p> <ul style="list-style-type: none"> ● Set up to prevent the brake deterioration due to the motor running. ● At servo-OFF during the motor is running , t_b of the right fig will be a shorter one of either Pr4.38 setup time, or time lapse till the motor speed falls below Pr4.39 setup speed. 												
												
Pr4.39	Name	Brake release speed setup			Mode							F
	Range	30~3000	Unit	1ms	Default	30	Index	2439h				
<p>When servo off, rotate speed less than this setup vale, and mechanical brake start delay time arrive, motor lost power.</p>												

Pr4.43	Name	E-stop function			Mode							F
	Range	0~1	Unit	-	Default	0	Index	2443h				
<p>0: When E-STOP is effective, the servo will forced to STOP and servo-disabled, and alarm showing (Err570) . 1: When E-STOP is effective, the servo will forced to STOP and keep in servo-enable, no alarm showing.</p>												

5.2.6 【Class 5】 Extended Setup

Pr5.04	Name	Over-travel inhibit input setup			Mode							F								
	Range	0~2	Unit	—	Default	0	Index	2504h												
<p>set to 1, no effect on homing mode.</p> <table border="1" data-bbox="311 1489 1316 1680"> <thead> <tr> <th>Setup value</th> <th>Details</th> </tr> </thead> <tbody> <tr> <td>0</td> <td>positive and negative limit effective, no alarm output</td> </tr> <tr> <td>1</td> <td>positive and negative limit effective invalid</td> </tr> <tr> <td>2</td> <td>positive and negative limit effective, alarm Err26.0</td> </tr> </tbody> </table> <p>In homing mode, POT/NOT invalid Settings please set the object dictionary 5012-04 bit0=1</p>													Setup value	Details	0	positive and negative limit effective, no alarm output	1	positive and negative limit effective invalid	2	positive and negative limit effective, alarm Err26.0
Setup value	Details																			
0	positive and negative limit effective, no alarm output																			
1	positive and negative limit effective invalid																			
2	positive and negative limit effective, alarm Err26.0																			

Pr5.06	Name	STOP mode			Mode							F						
	Range	0~1	Unit	—	Default	0	Index	2506h										
<p>Specify the status during deceleration and after stop, after servo-off.</p> <table border="1" data-bbox="311 1904 1436 2027"> <thead> <tr> <th>Setup value</th> <th>Details</th> </tr> </thead> <tbody> <tr> <td>0</td> <td>Disabled when disable signal effective and speed reduce to Pr4.39</td> </tr> <tr> <td>1</td> <td>Disabled when disable signal effective, free-run to stop</td> </tr> </tbody> </table>													Setup value	Details	0	Disabled when disable signal effective and speed reduce to Pr4.39	1	Disabled when disable signal effective, free-run to stop
Setup value	Details																	
0	Disabled when disable signal effective and speed reduce to Pr4.39																	
1	Disabled when disable signal effective, free-run to stop																	

Pr5.08	Name	LV trip selection at main power OFF			Mode															F						
	Range	0~1	Unit	—	Default	1	Index		2508h																	
You can select whether or not to activate Err0d.0 (main power under-voltage protection)function while the main shutoff continues for the setup of Pr5.09(The main power-OFF detection time).																										
<table border="1"> <thead> <tr> <th>Setup value</th> <th>Action of main power low voltage protection</th> </tr> </thead> <tbody> <tr> <td>0</td> <td>When the main power is shut off during Servo-On,Err0d.0 will not be triggered and the driver turns to Servo-OFF. The driver returns to Servo-On again after the main power resumption.</td> </tr> <tr> <td>1</td> <td>When the main power is shut off during Servo-On, the driver will trip due to Err0d.0</td> </tr> </tbody> </table>																					Setup value	Action of main power low voltage protection	0	When the main power is shut off during Servo-On,Err0d.0 will not be triggered and the driver turns to Servo-OFF. The driver returns to Servo-On again after the main power resumption.	1	When the main power is shut off during Servo-On, the driver will trip due to Err0d.0
Setup value	Action of main power low voltage protection																									
0	When the main power is shut off during Servo-On,Err0d.0 will not be triggered and the driver turns to Servo-OFF. The driver returns to Servo-On again after the main power resumption.																									
1	When the main power is shut off during Servo-On, the driver will trip due to Err0d.0																									
Caution: Err0d.0(main power under-voltage protection) is trigged when setup of Pr5.09 is long and P-N voltage of the main converter falls below the specified value before detecting the main power shutoff , regardless of the Pr5.08 setup.																										

Pr5.09	Name	The main power-OFF detection time			Mode																F
	Range	70~2000	Unit	1ms	Default	70	Index		2509h												
You can set up the time to detect the shutoff while the main power is kept shut off continuously. The main power off detection is invalid when you set up this to 2000.																					

Pr5.10	Name	Dynamic braking mode			Mode																F
	Range	0~2	Unit	-	Default	0	Index		2510h												
0: Dynamic braking is valid in both normal and abnormal situations 1: Dynamic braking is valid in normal situation, invalid in abnormal situation (To prevent abnormal situation, high speed and large inertia burn off the dynamic brake) 2: Dynamic braking is invalid in both normal and abnormal situations																					

Pr5.11	Name	Torque setup for emergency stop			Mode																F
	Range	0~500	Unit	%	Default	0	Index		2511h												
Set up the torque limit at emergency stop When setup value is 0, the torque limit for normal operation is applied. Compared with the maximum torque 6072, the actual torque limit value is smaller one.																					

Pr5.12	Name	Over-load level setup			Mode																F
	Range	0~115	Unit	%	Default	0	Index		2512h												
You can set up over-load level. The overload level becomes 115% by setting up this value to 0. Use this with 0 setup in normal operation, set up other value only when you need to low this over-load level. The setup value of this parameter is limited by 115% of the motor rating.																					

Pr5.13	Name	Over-speed level setup			Mode																F
	Range	0~1000 0	Unit	RPM	Default	0	Index		2513h												

If the motor speed exceeds this setup value, Err1A.0 [over-speed protect] occurs.
 The over-speed level becomes 1.2 times of the motor max, speed by setting up this to 0.

Pr5.20	Name	Position setup unit select			Mode					F
	Range	0~2	Unit	—	Default	2	Index	2520h		
Specify the unit to determine the range of positioning complete and excessive positional deviation										
Setup value					unit					
0					Encoder unit					
1					Command unit					
2					Standard 2500-line unit					

Pr5.21	Name	Selection of torque limit			Mode					F
	Range	0~2	Unit	—	Default	0	Index	2521h		
Set up the torque limiting method;										
Setup value		Positive limit value			Negative limit value					
0		Pr0.13			Pr0.13					
1		Pr0.13			Pr5.22					
2		60E0			60E1					
Compared with the maximum torque 6072, the actual torque limit value is smaller one										

Pr5.22	Name	2nd torque limit			Mode					F
	Range	0~500	Unit	%	Default	300	Index	2522h		
Set up the 2 nd limit value of the motor torque output The value of the parameter is limited to the maximum torque of the applicable motor. Compared with the maximum torque 6072, the actual torque limit value is smaller one										

Pr5.28	Name	LED initial status			Mode					F				
	Range	0~42	Unit	—	Default	34	Index	2528h						
You can select the type of data to be displayed on the front panel LED (7-segment) at the initial status after power-on.														
Setup value		content			Setup value		content			Setup value		content		
0		Positional command deviation			15		Over-load factor			30		Motor serial number		
1		Motor speed			16		Inertia ratio			31		Accumulated operation time		
2		Positional command speed			17		Factor of no-motor running			32		Automatic motor identification		
3		Velocity control command			18		No. of changes in I/O signals			33		Temperature information		
4		Torque command			19		Number of overcurrent signals			34		Servo state		
5		Feedback pulse sum			20		Absolute encoder data			35		/		
6		Command pulse sum			21		Absolute external scale position			36		Synchronous period		
7		Maximum torque during motion			22		Absolute multi-turn position			37		Synchronous loss time		
8					23		Communication axis			38		Synchronous type		

				address		
9	Control mode	24		Encoder positional deviation[encoder unit]	39	Whether DC is running or not
10	I/O signal status	25		Motor electromechanical angle	40	ACC/DEC
11	/	26		Motor mechanical Angle	41	Sub-index of OD index
12	Error factor and reference of history	27		Voltage across PN	42	The value of sub-index of OD index
13	Alarm code	28		Software version		
14	Regenerative load factor	29				

Note: Valid after restart the power.

Pr5.33	Name	Touch probe 1 signal compensation time			Mode							F
	Range	0~32767	Unit	25ns	Default	0	Index	2533h				
Time compensation for signal acquisition of touch probe 1 to provide more accurate capture position and prevent the instantaneous jitter of capture during master and slave cooperation												

Pr5.34	Name	Touch probe 2 signal compensation time			Mode							F
	Range	0~32767	Unit	25ns	Default	0	Index	2534h				
Time compensation for signal acquisition of touch probe 2 to provide more accurate capture position and prevent the instantaneous jitter of capture during master and slave cooperation												

Pr5.35	Name	Front panel lock setup			Mode							F
	Range	0~1	Unit	-	Default	0	Index	2535h				
Lock the operation on the front panel.												
		Setup value	content									
		0	No limit on the front panel operation									
		1	Lock the operation on the front panel									

Pr5.36	Name	7th setting parameters open			Mode							F
	Range	0/102	Unit	-	Default	0	Index	2536h				
7 th setting parameters open.												
		Setup value	content									
		0										
		102	Open 7 th setting parameters modification authority.									

Pr5.37	Name	Torque saturation alarm detection time			Mode							F
	Range	0~5000	Unit	ms	Default	500	Index	2537h				
When the duration of torque saturation reaches this value, the torque saturation signal will turn on.												

- 1、 Enable the torque saturation alarm, this parameter can be set to specify the output time of the torque saturation signal
- 2、 Disable the torque saturation alarm, this parameter can be set to specify the output time after the torque limit arrives while the homing method is torque detection.

Pr5.39	Name	3rd torque limit			Mode															F
	Range	0~500	Unit	%	Default	80	Index	2539h												
Set the torque limit of torque limit detection homing method. Compared with the maximum torque 6072, the actual torque limit value is smaller one.																				

5.2.7 【Class 6】 Special Setup

Pr6.01	Name	Encoder zero position compensation			Mode																F
	Range	0~360	Unit	°	Default	0	Index	2601h													
The Angle of the encoder after zero correction.																					

Pr6.04	Name	JOG trial run command speed			Mode																F
	Range	0~10000	Unit	r/min	Default	300	Index	2604h													
You can set up the command speed used for JOG trial run (velocity control).																					

Pr6.05	Name	Position 3rd gain valid time			Mode	PP				HM	CSP										
	Range	0~10000	Unit	0.1ms	Default	0	Index	2605h													
Set up the time at which 3 rd gain becomes valid. When not using this parameter, set PR6.05=0, PR6.06=100 This is valid for only position control/full-closed control.																					
Pr6.06	Name	Position 3rd gain scale factor			Mode	PP				HM	CSP										
	Range	0~1000	Unit	100%	Default	100	Index	2606h													
Set up the 3 rd gain by multiplying factor of the 1 st gain 3rd gain= 1st gain * Pr6.06/100																					

Pr6.07	Name	Torque command additional value			Mode																F
	Range	-100~100	Unit	%	Default	0	Index	2607h													
Pr6.08	Name	Positive direction torque compensation value			Mode																F
	Range	-100~100	Unit	%	Default	0	Index	2608h													
Pr6.09	Name	Negative direction torque compensation value			Mode																F
	Range	-100~100	Unit	%	Default	0	Index	2609h													
These three parameters may apply feed forward torque superposition directly to torque command.																					

Pr6.11	Name	Current response setup			Mode							F
	Range	50~100	Unit	%	Default	100	Index	2611h				
Set the effective value ratio of driver current loop related parameters.												

Pr6.12	Name	Setting of torque limit for zero correction of encoder.			Mode							F
	Range	-300~300	Unit	%	Default	50	Index	2612h				
Setting of torque limit for zero correction of encoder.												

Pr6.13	Name	2nd inertia ratio			Mode							F
	Range	0~10000	Unit	%	Default	0	Index	2613h				
Set up 2nd inertia ratio Set up the ratio of the load inertia against the rotor of the motor ratio. $PR6.13 = (\text{load inertia} / \text{rotor inertia}) * 100$ 【%】												

Pr6.14	Name	Emergency stop time at alarm			Mode							F
	Range	0~3000	Unit	ms	Default	200	Index	2614h				
Set up the time allowed to complete emergency stop in an alarm condition, exceeding this time puts this system in alarm state.												

Pr6.20	Name	Trial run distance			Mode							F
	Range	0~1200	Unit	0.1rev	Default	10	Index	2620h				
The distance of running each time in JOG run(position control)												

Pr6.21	Name	Trial run waiting time			Mode							F
	Range	0~30000	Unit	ms	Default	100	Index	2620h				
The waiting time after running each time in JOG run(position control)												

Pr6.22	Name	Trial run cycle times			Mode							F
	Range	0~32767	Unit	—	Default	1	Index	2622h				
The cycling times of JOG run(position control)												

Pr6.25	Name	Acceleration of trial running			Mode							F
	Range	0~32767	Unit	ms	Default	100	Index	2625h				
Acceleration of trial running												

Pr6.26	Name	Mode of trial running			Mode							F
	Range	0~32767	Unit	—	Default	0	Index	2626h				

0: Normal trial run mode
1: Aging mode for manufacturers

Pr6.34	Name	Frame error window time			Mode							F
	Range	0~32767	Unit	ms	Default	100	Index		2634h			
Set the EtherCAT data frame error alarm detection window time												

Pr6.35	Name	Frame error window			Mode							F
	Range	0~32767	Unit	ms	Default	50	Index		2635h			
Set the EtherCAT data frame error alarm detection window												

Pr6.61	Name	Z signal duration time			Mode							F
	Range	0~1000	Unit	ms	Default	10	Index		2661h			
Set the high level holding time of Z signal												
1、 Z signal for 60FDH; 2、 Z signal for homing process												

Pr6.62	Name	Overload warning threshold			Mode							F
	Range	0~99	Unit	%	Default	0	Index		2662h			
Before an overload alarm, pre-alarm.												

Pr6.63	Name	upper limit of multi - turn absolute position			Mode							F
	Range	0~32766	Unit	r	Default	0	Index		2663h			
While Pr0.15=2, the feedback position will loop between 0 - (Pr6.63+1)*Encoder resolution												

5.3 402 Parameters Function

Index 603FH	Name	Error code			-	Structure	VAR	Type	Uint 16
	Access	R0	Mapping	TPDO	Mode	ALL	Range	0-65535	Default

Index 6040H	Name	Control word				Structure	VAR	Type	Uint 16
	Access	RW	Mapping	RPDO	Mode	ALL	Range	0-65535	Default

	Mode Bit	15~11	10~9	8	7	6~4	3	2	1	0
	Definition	None	None	Pause	Error reset	Mode depends	Permitted operation	Quick stop	Voltage output	Start

Index 6041H	Name	Status word					Structure	VAR	Type	Uint 16
	Access	R0	Mapping	TPDO	Mode	ALL	Range	0-0XF FFF	Default	0
	Mode Bit	7	6	5	4	3	2	1	0	
	Definition	Reserved	Not started	Quick stop	Voltage output	Error	Permitted operation	Start	Ready to start	
	Mode Bit	15	14	13	12	11	10	9	8	
	Definition	Reserved	Reserved	Mode depends	Mode depends	Limit valid	Position arrived	Distance	Mode depends	

Index 605AH	Name	Quick stop option code					Structure	VAR	Type	INT 16
	Access	RW	Mapping	-	Mode	ALL	Range	0-7	Default	0
	pp, csp, ip, csv, pv 0 : Stop according to 3506h(Sequence at Servo-off), keeping Switch on disabled 1 : Stop according to 6084h(Profile deceleration), keepng Switch on disabled 2 : Stop according to 6085h(Quick stop deceleration), keeping Switch on disabled 3 : Stop according to 60C6h(Max deceleration), keeping Switch on disabled 5 : Stop according to 6084h(Profile deceleration), keeping Quick stop active 6 : Stop according to 6085h(Quick stop deceleration), keeping Quick stop active 7 : Stop according to 60C6h(Max deceleration), keeping Quick stop active hm 0 : Stop according to 3506h(Sequence at Servo-off), keeping Switch on disabled 1 : Stop according to 609Ah(Homing acceleration), keeping Switch on disabled 2 : Stop according to 6085h(Quick stop deceleration), keeping Switch on disabled 3 : Stop according to 60C6h(Max deceleration), keeping Switch on disabled 5 : Stop according to 609Ah(Homing acceleration), keeping Quick stop active 6 : Stop according to 6085h(Quick stop deceleration), keeping Quick stop active 7 : Stop according to 60C6h(Max deceleration), keeping Quick stop active cst 0 : Stop according to 3506h(Sequence at Servo-off), keeping Switch on disabled 1, 2 : Stop according to 6087h(Torque slope), keeping Switch on disabled 3 : Stop according to torque=0, keeping Switch on disabled 5, 6 : Stop according to 6087h(Torque slope), keeping Quick stop active 7 : Stop according to torque=0, keeping Quick stop active									

Index 605DH	Name	Halt option code					Structure	VAR	Type	INT 16
	Access	RW	Mapping	-	Mode	ALL	Range	1-3	Default	1

pp, csp, csv, pv

- 1 : Stop according to 6084h(Profile deceleration), keeping Operation enabled
- 2 : Stop according to 6085h(Quick stop deceleration), keeping Operation enabled
- 3 : Stop according to 6072h(Max torque)、60C6h(Max deceleration), Stop according to torque=0Operation enabled

hm

- 1 : Stop according to 609Ah(Homing acceleration), keeping Operation enabled
- 2 : Stop according to 6085h(Quick stop deceleration), keeping Operation enabled
- 3 : Stop according to 6072h(Max torque)、60C6h(Max deceleration), keeping peration enabled

cst

- 1, 2 : Stop according to 6087h(Torque slope), keeping Operation enabled
- 3 : Stop according to torque=0, keeping Operation enabled

Index	Name	Shutdown code			Mode						F
605BH	Range		Unit		Default		Index				
(1) When the PDS command 「Shutdown」 receives pp, csp, csv, pv 0 : Stop according to 3506h(Sequence at Servo-off), keeping Ready to switch on 1 : Stop according to 6084h(Profile deceleration), keeping Ready to switch on hm 0 : Stop according to 3506h(Sequence at Servo-off), keeping Ready to switch on 1 : Stop according to 609Ah(Homing acceleration), keeping Ready to switch on cst 0 : Stop according to 3506h(Sequence at Servo-off), keeping Ready to switch on 1 : Stop according to 6087h(Torque slope), keeping Ready to switch on (2) When the PDS command 「Disable voltage」 receives pp, csp, csv, pv 0 : Stop according to 3506h(Sequence at Servo-off), keeping Switch on disabled 1 : Stop according to 6084h(Profile deceleration), keeping Switch on disabled hm 0 : Stop according to 3506h(Sequence at Servo-off), keeping Switch on disabled 1 : Stop according to 609Ah(Homing acceleration), keeping Switch on disabled cst 0 : Stop according to 3506h(Sequence at Servo-off), keeping Switch on disabled 1 : Stop according to 6087h(Torque slope), keeping Switch on disabled											

Index	Name	Disableoperation code			Mode						F
605CH	Range		Unit		Default		Index				
(1) When the PDS command 「Disable voltage」 receives pp, csp, csv, pv 0 : Stop according to 3506h(Sequence at Servo-off), keeping Switch on disabled 1 : Stop according to 6084h(Profile deceleration), keeping Switch on disabled hm 0 : Stop according to 3506h(Sequence at Servo-off), keeping Switch on disabled 1 : Stop according to 609Ah(Homing acceleration), keeping Switch on disabled cst 0 : Stop according to 3506h(Sequence at Servo-off), keeping Switch on disabled 1 : Stop according to 6087h(Torque slope), keeping Switch on disabled											

pp, csp, csv, pv

0 : Stop according to 3506h(Sequence at Servo-off), keeping Switched on

1 : Stop according to 6084h(Profile deceleration), keeping Switched on

hm

0 : Stop according to 3506h(Sequence at Servo-off), keeping Switched on

1 : Stop according to 609Ah(Homing acceleration), keeping Switched on

cst

0 : Stop according to 3506h(Sequence at Servo-off), keeping Switched on

1 : Stop according to 6087h(Torque slope), keeping Switched on

Index	Name	Operation mode					Structure	VAR	Type	Int 8																								
	6060H	Access	RW	Mapping	RPDO	Mode	ALL	Range	0-10	Default	0																							
<table border="1"> <thead> <tr> <th>NO</th> <th>Mode</th> <th></th> </tr> </thead> <tbody> <tr> <td>1</td> <td>Profile position mode</td> <td>PP</td> </tr> <tr> <td>3</td> <td>Profile velocity mode</td> <td>PV</td> </tr> <tr> <td>4</td> <td>profile Torque mode</td> <td>PT</td> </tr> <tr> <td>6</td> <td>Homing mode</td> <td>HM</td> </tr> <tr> <td>8</td> <td>Cyclic synchronous position mode</td> <td>CSP</td> </tr> <tr> <td>9</td> <td>Cyclic synchronous velocity mode</td> <td>CSV</td> </tr> <tr> <td>10</td> <td>Cyclic synchronous torque mode</td> <td>CST</td> </tr> </tbody> </table>											NO	Mode		1	Profile position mode	PP	3	Profile velocity mode	PV	4	profile Torque mode	PT	6	Homing mode	HM	8	Cyclic synchronous position mode	CSP	9	Cyclic synchronous velocity mode	CSV	10	Cyclic synchronous torque mode	CST
NO	Mode																																	
1	Profile position mode	PP																																
3	Profile velocity mode	PV																																
4	profile Torque mode	PT																																
6	Homing mode	HM																																
8	Cyclic synchronous position mode	CSP																																
9	Cyclic synchronous velocity mode	CSV																																
10	Cyclic synchronous torque mode	CST																																

Index	Name	Displayed operation mode					Structure	VAR	Type	Int 8																								
	6061H	Access	RO	Mapping	TPDO	Mode	ALL	Range	0-10	Default	0																							
<table border="1"> <thead> <tr> <th>NO</th> <th>Mode</th> <th></th> </tr> </thead> <tbody> <tr> <td>1</td> <td>Profile position mode</td> <td>PP</td> </tr> <tr> <td>3</td> <td>Profile velocity mode</td> <td>PV</td> </tr> <tr> <td>4</td> <td>profile Torque mode</td> <td>PT</td> </tr> <tr> <td>6</td> <td>Homing mode</td> <td>HM</td> </tr> <tr> <td>8</td> <td>Cyclic synchronous position mode</td> <td>CSP</td> </tr> <tr> <td>9</td> <td>Cyclic synchronous velocity mode</td> <td>CSV</td> </tr> <tr> <td>10</td> <td>Cyclic synchronous torque mode</td> <td>CST</td> </tr> </tbody> </table>											NO	Mode		1	Profile position mode	PP	3	Profile velocity mode	PV	4	profile Torque mode	PT	6	Homing mode	HM	8	Cyclic synchronous position mode	CSP	9	Cyclic synchronous velocity mode	CSV	10	Cyclic synchronous torque mode	CST
NO	Mode																																	
1	Profile position mode	PP																																
3	Profile velocity mode	PV																																
4	profile Torque mode	PT																																
6	Homing mode	HM																																
8	Cyclic synchronous position mode	CSP																																
9	Cyclic synchronous velocity mode	CSV																																
10	Cyclic synchronous torque mode	CST																																

Index	Name	Actual internal position value				-	Structure	VAR	Type	Dint 32
	6063H	Access	RO	Mapping	TPDO	Mode	ALL	Range	Encoder unit	Default
Actual internal position value, Encoder unit										

Index	Name	Actual feedback position value				-	Structure	VAR	Type	Dint 32
	6064H	Access	RO	Mapping	TPDO	Mode	ALL	Range	Command Unit	Default

Actual feedback position value, Command Unit.

6064h * gear ratio = 6063h

Index	Name	Motor rotation direction					Structure	VAR	Type	Uint 8
	607EH	Access	RW	Mapping	RPDO	Mode	ALL	Range	00-FF	Default
		Mode		Value						
		Position mode	PP	0: Rotate in the same direction as the position command 128: Rotate in the opposite direction as the position command						
			HM							
			CSP							
		Velocity mode	PV	0: Rotate in the same direction as the position command 64: Rotate in the opposite direction as the position command						
			CSV							
		Torque mode	PT	0: Rotate in the same direction as the position command 32: Rotate in the opposite direction as the position command						
			CST							
		ALL mode		0: Rotate in the same direction as the position command 224: Rotate in the opposite direction as the position command						
Index	Name	Encoder resolution				-	Structure	VAR	Type	Dint 32
	608FH-01	Access	R0	Mapping	TPDO	Mode	ALL	Range	Default	
Read motor encoder resolution										
Index	Name	Electron gear molecule				-	Structure	VAR	Type	Dint 32
	6091H-01	Access	RW	Mapping	RPDO	Mode	ALL	Range	Default	
Set the resolution of motor encoder										
Index	Name	Electronic gear denominator				-	Structure	VAR	Type	Dint 32
	6091H-02	Access	RW	Mapping	RPDO	Mode	ALL	Range	Command unit	Default -
Set the number of pulses required for one motor rotation.										
Index	Name	Number of pulses per rotation				-	Structure	VAR	Type	Dint 32
	6092H-01	Access	RW	Mapping	RPDO	Mode	ALL	Range	Command unit	Default -
If 6092h_01(Feed constant) is not equal to 608Fh(Position encoder resolution), then: Electronic gear ratio = Encoder resolution / 6092h_01 If 6092h_01(Feed constant) is equal to 608Fh(Position encoder resolution), then: Electronic gear ratio = 6091_01 / 6092h_01										

Index	Name	Homing method					Structure	VAR	Type	Uint 8
	6098H	Access	RW	Mapping	RPDO	Mode	ALL	Range	0-35	Default
		-6	Search the homing point with low speed negative direction, when the torque reached then stop immediately							
		-5	Search the homing point with low speed positive direction, when the torque reached then stop immediately							
		-4	Search the homing point with low speed negative direction, when the torque reached then change the motion direction, when the torque is gone then stop immediately							
		-3	Search the homing point with low speed positive direction, when the torque reached then change the motion direction, when the torque is gone then stop immediately							
		-2	Search the homing point with low speed negative direction, when the torque reached then reverse the direction, when the torque is gone and Z signal coming then stop immediately							
		-1	Search the homing point with low speed positive direction, when the torque reached then reverse							

	the direction, when the torque is gone and Z signal coming then stop immediately
1	Search the homing point in negative direction, deceleration point is negative limit switch, homing point is motor Z signal, the negative limit switch falling edge must come before Z signal
2	Search the homing point in positive direction, deceleration point is positive limit switch, homing point is motor Z signal, the positive limit switch falling edge must come before Z signal
3	Search the homing point in positive direction, deceleration point is homing switch, homing point is motor Z signal, the falling edge on the same side of homing switch must come before Z signal
4	Search the homing point in negative direction, deceleration point is homing switch, homing point is motor Z signal, the rising edge on the same side of homing switch must come before Z signal
5	Search the homing point in negative direction, deceleration point is homing switch, homing point is motor Z signal, the falling edge on the same side of homing switch must come before Z signal
6	Search the homing point in positive direction, deceleration point is homing switch, homing point is motor Z signal, the rising edge on the same side of homing switch must come before Z signal
7	Search the homing point in positive direction, deceleration point is homing switch, homing point is motor Z signal, the falling edge on the same side of homing switch must come before Z signal
8	Search the homing point in positive direction, deceleration point is homing switch, homing point is motor Z signal, the rising edge on the same side of homing switch must come before Z signal
9	Search the homing point in positive direction, deceleration point is homing switch, homing point is motor Z signal, the rising edge on the other side of homing switch must come before Z signal
10	Search the homing point in positive direction, deceleration point is homing switch, homing point is motor Z signal, the falling edge on the other side of homing switch must come before Z signal
11	Search the homing point in negative direction, deceleration point is homing switch, homing point is motor Z signal, the falling edge on the same side of homing switch must come before Z signal
12	Search the homing point in negative direction, deceleration point is homing switch, homing point is motor Z signal, the rising edge on the same side of homing switch must come before Z signal
13	Search the homing point in negative direction, deceleration point is homing switch, homing point is motor Z signal on the other side of homing switch, the rising edge on the other side of homing switch must come before Z signal
14	Search the homing point in negative direction, deceleration point is homing switch, homing point is motor Z signal on the other side of homing switch, the falling edge on the other side of homing switch must come before Z signal
15	
16	
17-3	Similar with 1-14, but the deceleration point coincides with the homing point
2	
33	Search the homing point in negative direction, homing point is motor Z signal
34	Search the homing point in positive direction, homing point is motor Z signal
35	Set the current position as homing point

Index 60B8H	Name	Touch probe control word					Structure	VAR	Type	Uint 16
	Access	RW	Mapping	RPDO	Mode	ALL	Range	0-65535	Default	0

Index 60FDH	Name	Status of input					Structure	VAR	Type	DINT 32
	Access	R0	Mapping	TPDO	Mode	ALL	Range	0-ffff	Default	
The bits of a 60FDh object are functionally defined as follow:										
Bit31	Bit30	Bit29	Bit28	Bit27	Bit26	Bit25	Bit24			
Z signal	Reserved	Reserved	Reserved	Touch Probe 2	Touch Probe 1	BRAKE	INP/V-C OIN /TLC			
Bit23	Bit22	Bit21	Bit20	Bit19	Bit18	Bit17	Bit16			
E-STOP	Reserved	Reserved	Reserved	Reserved	Reserved	SI14	SI13			
Bit15	Bit14	Bit13	Bit12	Bit11	Bit10	Bit9	Bit8			
SI12	SI11	SI10	SI9	SI8	SI7	SI6	SI5			
Bit7	Bit6	Bit5	Bit4	Bit3	Bit2	Bit1	Bit0			
SI4	SI3	SI2	SI1	Reserved	HOME	POT	NOT			

Index 60FEH-01	Name	Output valid					Structure	VAR	Type	UintT 32
	Access	RW	Mapping	RPDO	Mode	ALL	Range	0-ffff	Default	0
The bits of a 60FEh object are functionally defined as follow:										
Bit	31~21	21	20	19	18	17	16	15~0		
Sub-index										
01h	Reserved	SO6 valid	SO5 valid	SO4 valid	SO3 valid	SO2 valid	SO1 valid	Reserved		

Index 60FEH-02	Name	Output enable					Structure	VAR	Type	UintT 32
	Access	RW	Mapping		Mode	ALL	Range	0-ffff	Default	0
The bits of a 60FEh object are functionally defined as follow:										
Bit	31~21	21	20	19	18	17	16	15~0		
Sub-index										
02h	Reserved	SO6 enable	SO5 enable	SO4 enable	SO3 enable	SO2 enable	SO1 enable	Reserved		

Chapter 6 EtherCAT

6.1 EtherCAT Introduction

In the traditional Ethernet network, each device can receive all packets in the network, and the useful information of the specified device must be extracted one by one in the application layer, which seriously affects the execution efficiency of the application layer.

EtherCAT technology breaks through the system limitations of traditional Ethernet solutions and does not have to accept all the packets in Ethernet at every connection point like other Ethernet. When a data frame passes through each device, the EtherCAT slave device reads the corresponding addressing data as a message passes through its node. Also, the input data can be inserted into the message when a message through the frame is passed a few nanoseconds (delay) in the past, from the station to identify relevant orders, and processing the process is out of the station controller through hardware implementation, thus has nothing to do with the protocol stack processor performance with Ethernet frames to a lot of equipment data, in the direction of sending and receiving, the available data rate increase to more than 90%, to 100 basetx full-duplex more full use of the function, make the effective data rate > 100 MBit/S (> 2 100 MBit/S (90%) can be achieved.

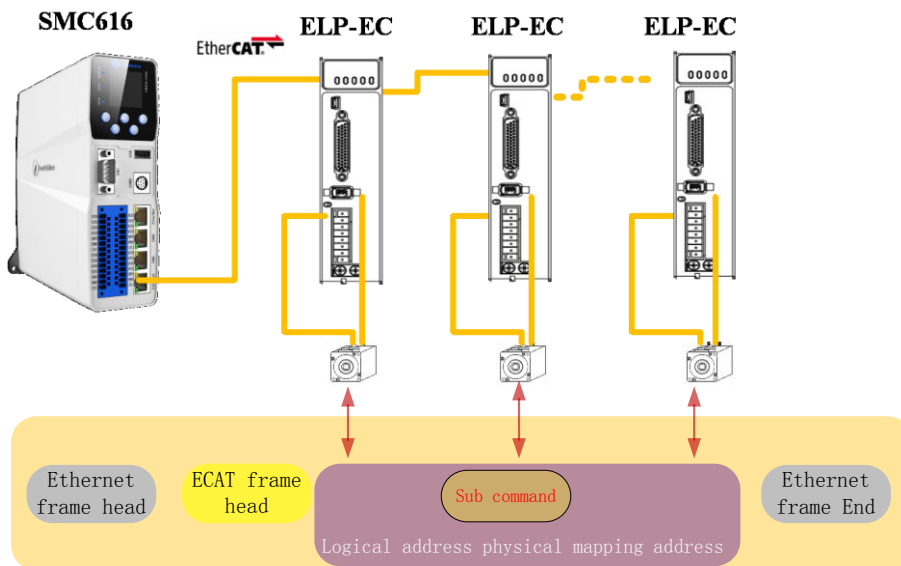

Figure 6.1 Packet loading of process data

6.2 Synchronous Mode

6.2.1 Free Operation Mode

In the free operation mode, EL7-EC processes the process data sent by the master station asynchronously. It only applies to asynchronous motion mode, such as origin mode, protocol position mode, etc

6.2.2 Distributed clock synchronization mode

EL7-EC adopts the synchronous mode of distributed clock as shown in figure 6.2. When the master station sends the process data to the slave station, the slave station immediately reads the process data, and then waits for the synchronization signal to trigger the process data to act on the driver

The process data must arrive at the EL7-EC driver before the time of SYNC0 signal T_1 . The driver has completed the analysis of the process data and relevant control calculation before the arrival of SYNC0 event. After receiving SYNC0 event, EL7-EC immediately implements the control action, which has a high synchronization performance.

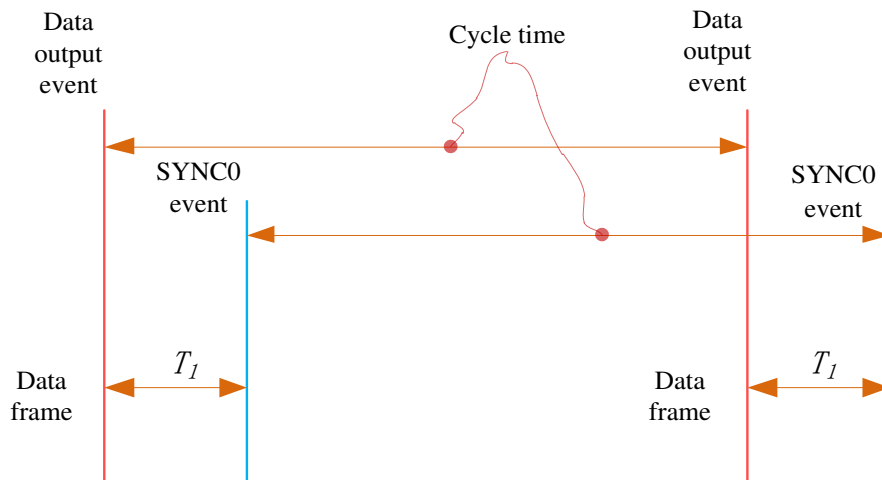

Figure 6.2 High performance synchronization mode

6.3 EtherCAT communication state

EtherCAT state, commonly known as "communication state", is mainly used to manage communication between master and slave stations. The communication function mainly includes mailbox and process data communication. The EtherCAT state transition relationship is shown in figure 6.3

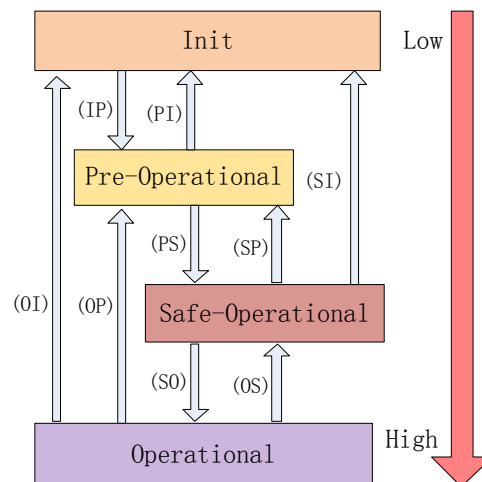

Figure 6.3 EtherCAT state transitions

EtherCAT state transitions have the following characteristics:

- ① From initialization to operational, the conversion must be carried out strictly in the order of initializing > pre-operational > safe operational > operational, from low to high, and no grade skipping is allowed
- ② When converting from high to low, grade skipping is allowed.
- ③ If the state transition for the master station request fails, the slave station sends an error message to the master station.

Table 6.1 EtherCAT Communication function of state

State and transition	Communicating function
Init	No communication between master and slave stations
Pre-Operational	Mailbox communication is effective, no process data communication, SDO function is valid
Safe-Operational	Mailbox communication and sending process data object is valid, SDO and TXPDO are valid
Operational	Mailbox communication, receive and send process data object valid, SDO、RXPDO and TXPDO valid

6.4 CANopen Over EtherCAT

6.4.1 Network structure of EL7-EC

The structure of EL7-EC servo system network module is shown in figure 6.4

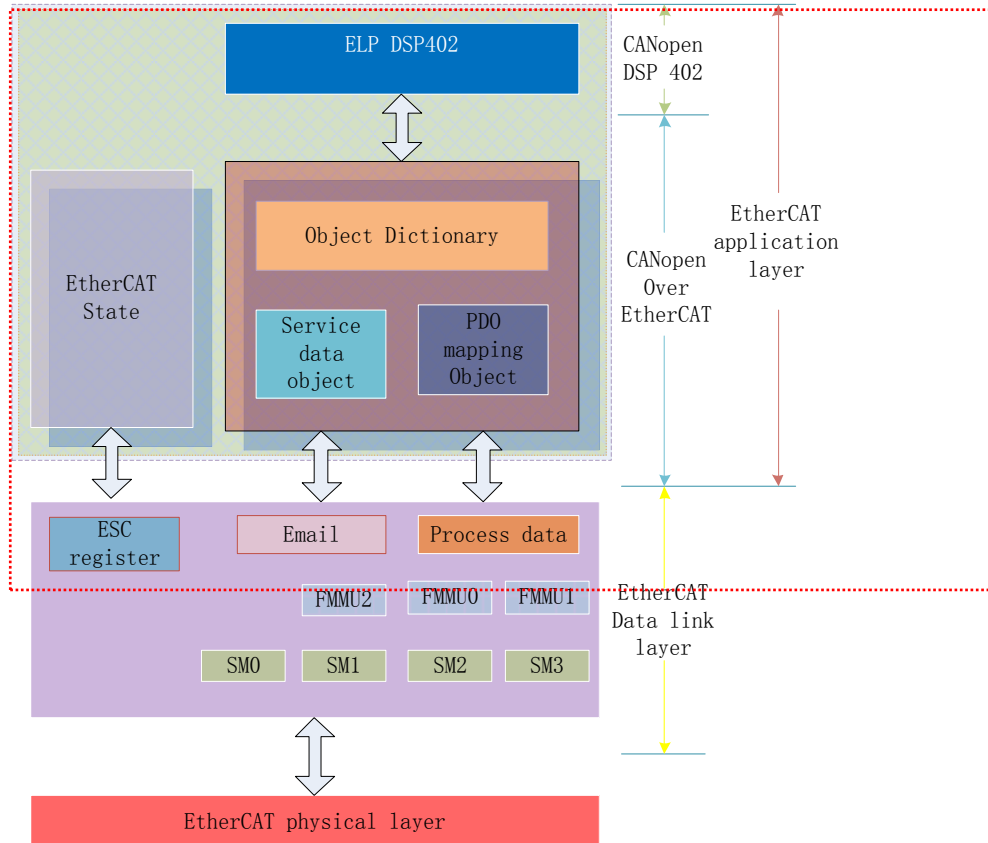

Figure 6.4 The structure of EL7-EC network module

The data link layer implementation is mainly implemented by EtherCAT slave station controller (ESC). EL7-EC EtherCAT application layer protocol mainly includes application part (CANopen DSP402), object dictionary and communication function (red frame part), among which object dictionary and communication function can be jointly called COE part.

Object dictionary——Bridge of communication function and application part.

Communication function——Implementation of communication rules (SDO, PDO, etc.)

Application part——Define the specific function of the device, such as the driver, IO module.

6.4.2 Object dictionary

The EtherCAT master controls the EL7-EC drive by writing and reading device state /information. To do this, the drive defines read-write parameters and read-only state values, The collection of these parameters and states is the object dictionary.

The EL7-EC object dictionary contains all DSP402 and Coe related data objects in a standardized manner. It is a collection of EL7-EC parameter data structures.

The EL7-EC object dictionary is the interface with which the primary station communicates.

EtherCAT master implements EL7-EC motion control through the interface of object dictionary.

6.4.3 Service Data Objects(SDO)

The EL7-EC series of servos supports SDO services, and the EtherCAT master can configure, monitor, and control EL7-ec servos by using SDO to read and write EL7-ec object dictionaries.

In traditional CANopen DS301 mode, SDO protocol CAN only transfer 8 bytes at a time to match the data length of CAN message. In COE enhancement mode, only the payload data is expanded without changing the protocol head; In this way, the SDO protocol uses mailboxes with larger data lengths, thus improving the transmission efficiency of big data.

6.4.4 Process Data Objects(PDO)

6.4.4.1 PDO Introduction

PDO is generally used for real-time data updates, It is divided into receiving PDO(RXPDO) and sending PDO(TXPDO). The data stream direction of receiving PDO is from the master station to the slave station, while sending PDO is from the master station to the master station

The PDO function of EL7-EC supports both synchronous cycle refresh mode and non-periodic update mode. When the master station selects distributed clock synchronization mode, PDO will update according to the synchronization cycle. If free run mode is selected, updates to PDO data will be aperiodic.

6.4.4.2 PDO mapping

Through PDO mapping, the real-time transmission of mapped objects can be realized.

EL7-EC supports simultaneous transmission of 2 sets of RXPDO and 2 sets of TXPDO. Each PDO object can map 8 object dictionary (maximum length 32 bytes). The format of PDO mapping content is shown in table 6.2

Table 6.2 Format of PDO mapping

Bit	31~16	15~8	7~0
Details	The index of mapped object	The subindex of mapped object	Bit length (Hex)
Example	6040h	00h	10h(16bit)

The default PDO mapping (consistent with the XML file) is shown in table 6.3

Table 6.3 The default PDO mapping

PDO Map object index	PDO Map object Sub-index	Mapping content	Map content decomposition			Details
			Index	Sub-index	Bit length	
RXPDO1 (1600h)	01h	60400010h		00h	10h(16 bit)	01h
	02h	607A0020h		00h	10h(16 bit)	02h
	03h	60B80020h		00h		03h
RXPDO2 (1601h)	01h	60400010h	6040h	00h	10h(16 bit)	Control word
	02h	60FF0020h	60FFh	00h	20h(32 bit)	Target velocity
	03h	60B20010h	60B2h	00h	10h(16 bit)	Torque feedforward
RXPDO3 (1602h)	01h	60400010h	6040h	00h	10h(16 bit)	Control word
	02h	60710010h	6071h	00h	10h(16 bit)	Target torque
	03h	60870020h	6084h	00h	20h(32 bit)	Profile deceleration
RXPDO4 (1603h)	01h	60400010h	6040h	00h	10h(16 bit)	Control word
	02h	60980008h	6098h	00h	08h(8 bit)	Homing method
	03h	60990120h	6099h	01h	20h(32 bit)	High speed of homing
	04h	60990220h	6099h	02h	20h(32 bit)	Low speed of homing
	05h	609A0020h	609Ah	00h	20h(32 bit)	Homing acceleration
	06h	607C0020h	607Ch	00h	20h(32 bit)	Homing position offset
	07h	60600008h	6060h	00h	08h(8 bit)	Operation mode
TXPDO1 (1A00h)	01h	603F0000h				
	02h	60410000h				
	03h	60610000h				
	04h	60640000h				
	05h	60B90020h				
	06h	60BA0020h				
	07h	60FD0020h				
TXPDO2 (1A01h)	No default mapping					

6.4.4.3 dynamic mapping

Different from CIA DS301, COE uses PDO specified objects (1C12h/1C13h) to configure PDO mapped objects (1600h~1603h/1A00h~1A01h) to PDO object synchronization manager (synchronization manager 2/3). PDO specified objects are defined in table 6.4

Table 6.4 PDO specifies object definitions

Index	Sub-index	Range	Data type	Access
RXPDO (1C12h)	00h	0~4	U8*1)	RO *2)
	01h	1600h~1603h	U16	RW
	02h		U16	RW
	03h		U16	RW
	04h		U16	RW
TXPDO (1C13h)	00h	0~2	U8	RO
	01h	1A00h~1A01h	U16	RW
	02h		U16	RW

*1) U represents unsigned type, such as U8 for unsigned 8 bits and U16 for unsigned 16 bits

*2) Access property expression, RO means read only, RW means read and write, WO means write only

6.4.4.4 PDO dynamic mapping setup procedure

- A、 Switch the EtherCAT state to pre-operational, then you can configure the PDO map with SDO.
- B、 Clear the PDO mapping object of the PDO specified object, that is, set 1C12-00h / 1C13-00h to 0.
- C、 Invalidate the PDO mapping object, that is, assign 0 to the subindex 0 of 1600h~1603h /1A00h~1A01h.
- D、 Reconfigure the PDO mapping content, and write the mapping object into the objects in the range of 1600-01h~1600-08h, 1601-01h~1601-08h, 1602-01h~1602-08h 、1603-01h~1603-08h (RXPDO mapping content from 1600h-01)、 1A00-01h ~ 1A00-08h or 1A01-01h~1A01-08h (TXPDO mapping content from 1a00h-01) according to Table 6.3
- E、 Set the total number of PDO mapping objects, write the number of mapping objects into 1600-00h, 1601-00h, 1602-00h, 1603-00h, 1A00-00h or 1A01-00h, and the total number of PDO mapping objects without configured mapping content will be 0.
- F、 Write valid PDO mapping object index to PDO specified object, that is, write valid RXPDO mapping object index 1600h~1603h into 1C12-01h ~ 1C12-04h, write effective TXPDO mapping object index 1A00h、 1A01h into 1C13-01h、 1C13-02h.
- G、 Set the total number of objects specified by PDO, writing the number of mapped objects to 1C12-00h and 1C13-00h.
- H、 Switch the EtherCAT state.
- I、 Reach safe-Operational or above, the configured PDO mapping will be valid.

6.5 Slave station alias and network status display

6.5.1 Setting

EL7-EC can set the site alias through the operation panels Pr0.23(corresponding object dictionary 2023h) and Pr0.24(corresponding object dictionary 2024h).

6.5.2 Network status display

The network connection status is determined by the LED light on CN4 and CN5 port.

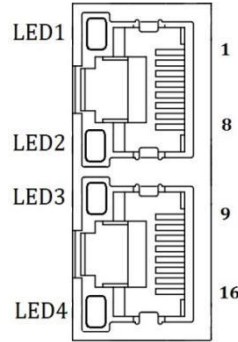
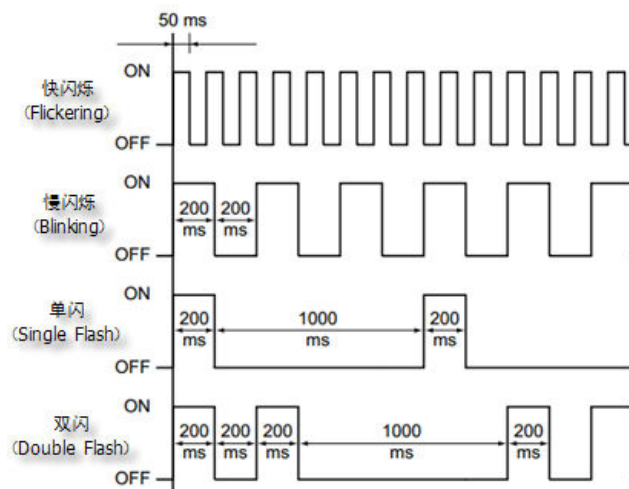

Figure 6.6 CN4 and CN5 port

- ①LED1: Link/Activity IN status, Green.
- ②LED3: Link/Activity OUT status, Green.
- ③LED2: RUN status, Green. EtherCAT state machine.
- ④LED4: ERR status, Red.

Table 6.5 LED Display

Name	Color	Status	Details
RUN	Green	(OFF)	Init
		(Blinking)	Pre-Operational
		(Single flash)	Safe-Operational
		(ON)	Operational
ERR	Red	(OFF)	Refer to chapter4.3 for more details
		(Blinking)	
		(Single flash)	
		(Double flash)	
		(Flickering)	
L/A IN	Green	(OFF)	Physical layer link not established
		(ON)	Physical layer link established
		(Flickering)	Interactive data after link established
L/A OUT	Green	(OFF)	Physical layer link not established
		(ON)	Physical layer link established
		(Flickering)	Interactive data after link established

State description of indicator light is shown in figure 6.7

Figure 6.7 State description of LED

Chapter 7 EL7-EC Control Mode

7.1 EL7-EC motion control procedure

- A. The EtherCAT master sends "control word (6040h)" to initialize the drive.
- B. Driver feedback "status word (6041h)" to the main station to show ready status (status word indication) .
- C. Master station send enable command (control word switch).
- D. The driver enables and feeds back to the master station.
- E. The master station sends homing command to return to homing point (return to homing point motion parameters and control word switch)
- F. Driver returns to homing point complete and notifies master station (status word indication)
- G. The master station sends the position mode command for position movement (position motion parameters and control word switch) or sends the speed command for speed movement (speed motion parameters and control word switch).
- H. When the driver is finished executing the movement (position movement), EL7-EC feeds back the position/speed to the master station for monitoring during the movement
- I. The master station sends commands for the next movement.

7.2 CIA402 State Machine

7.2.1 State machine switchover diagram

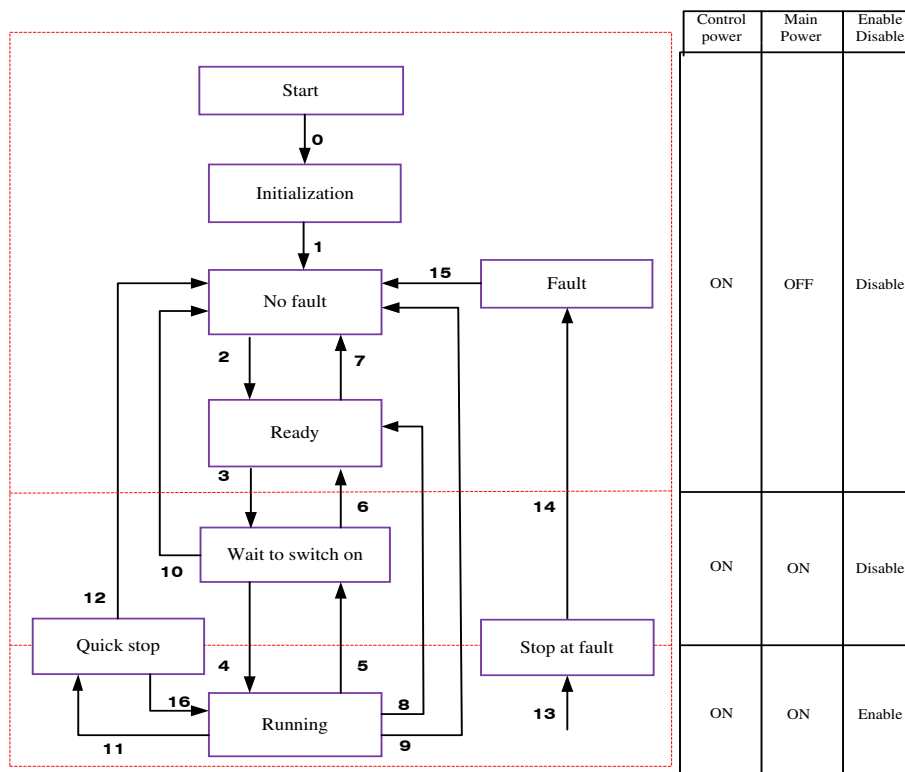

Figure 7.1 EL7-EC 402 State Machine switchover diagram

The states are described in the following stable 7.1

Table 7.1 State description

States	Details
Initialization	Initialization of the servo drive and self-check have been done. Parameter setting or drive function cannot be implemented. If there is brake, the brake will not release, servo disabled.
No fault	No fault exists in the servo drive or the fault is eliminated Parameter setting of the servo drive is allowed.
Ready	The servo drive is ready. Parameter setting of the servo drive is allowed.
Wait to switch on	The servo drive waits to swich on. Parameter setting of the servo drive is allowed.
Running	The servo drive is in normal running state; a certain control mode is enabled; The motor is energized, and rotates when the reference is not 0. Parameters with the setting condition of 'during running' can be set.
Quick stop	The quick stop function is enabled, and the servo drive executes quick stop. Parameters with the setting condition of 'during running' can be set.
Stop at fault	A fault occurs, and the servo drive stops. Parameters with the setting condition of 'during running' can be set.
Fault	The stop process is completed, and all the drive function are inhibited. Parameter setting is allowed for users to eliminate faults.

The conversion of CIA402 state machine is accomplished by the control word (6040h) of the EL7-EC servo system operated by the master station.

7.3 Drive Mode Setting

7.3.1 Driver Mode Description (6502h)

The EL7-EC supports seven mode, as defined in 6502h.

Bit	31~10	9	8	7	6	5	4	3	2	1	0
Mode	Reserved	CST	CSV	CSP	Reserved	HM	Reserved	PT	PV	Reserved	PP
1:Supported	0	1	1	1	0	1	0	1	1	0	1

Description	Short Name
Profile position mode	PP
Profile velocity mode	PV
profile Torque mode	PT
Homing mode	HM
Cyclic synchronous position mode	CSP
Cyclic synchronous velocity mode	CSV
Cyclic synchronous torque mode	CST

7.3.2 Operation mode setting(6060h) and Opreation mode display (6061h)

The operation mode of the servo drive is set in 6060h. The operation mode of the servo drive is viewed in 6061h.

Value	Description	Short Name
1	Profile position mode	PP
3	Profile velocity mode	PV
4	profile Torque mode	PT
6	Homing mode	HM
8	Cyclic synchronous position mode	CSP
9	Cyclic synchronous velocity mode	CSV
10	Cyclic synchronous torque mode	CST

7.4 Common Functions for All Modes

7.4.1 Digital Input/Output

7.4.1.1 Digital input setting and status display

The selection of digital IO input function and polarity setting are introduced in detail in the chapter IO setting of parameters in chapter 5. EL7-EC provides a mapping method for two IO input states. The lower 16 bits of 3000h object are used to indicate the physical state of digital IO input. The definition is shown in the table.

Bit	IO
0	SI1 status
1	SI2 status
2	SI3 status
3	SI4 status
4	SI5 status
5	SI6 status
6	SI7 status
7	SI8 status
8	SI9 status
9	SI10 status
10	SI11 status
11	SI12 status
12	SI13 status
13	SI14 status
14~15	Reserved

60FDh object is an input IO state mapping object conforming to IEC61800-200 standard. Different from 3000h , it does not correspond to the physical port state. The bits of 60FDh object are functionally defined, as listed in the table.

Bit31	Bit30	Bit29	Bit28	Bit27	Bit26	Bit25	Bit24
Z signal	Reserved	Reserved	Reserved	Touch Probe 2	Touch Probe 1	BRAKE	INP/V-COIN /TLC
Bit23	Bit22	Bit21	Bit20	Bit19	Bit18	Bit17	Bit16
E-STOP	Reserved	Reserved	Reserved	Reserved	Reserved	SI14	SI13
Bit15	Bit14	Bit13	Bit12	Bit11	Bit10	Bit9	Bit8
SI12	SI11	SI10	SI9	SI8	SI7	SI6	SI5
Bit7	Bit6	Bit5	Bit4	Bit3	Bit2	Bit1	Bit0
SI4	SI3	SI2	SI1	Reserved	HOME	POT	NOT

7.4.1.2 Digital output setting and control operation method

Digital IO output function selection and polarity Settings detailed description of the IO Settings section. The higher 16bit of 3000h is used to indicate the physical state of the output of digital IO, and its definition is shown in the table.

Bit	IO
16	SO1 status
17	SO2 status
18	SO3 status
19	SO4 status
20	SO5 status
21	SO6 status
22~31	Reserved

In addition to the internal operation of the servo system, EL7-ec also provides a function for the master station to operate the servo digital IO output.

When the digital IO output function is set up for the master station control, the master station can operate EL7-EC servo digital IO output through 60FEh object. The specific definition of 60FEh is shown in the table.

Bit Sub-index	31~21	21	20	19	18	17	16	15~0
01h	Reserved	SO6 valid	SO5 valid	SO4 valid	SO3 valid	SO2 valid	SO1 valid	Reserved
02h		SO6 enable	SO5 enable	SO4 enable	SO3 enable	SO2 enable	SO1 enable	

The digital IO output function is defined in 3005h.

Bit	Function
0	Alarm output
1	Servo-Ready output
2	Eternal brake release signal
3	Positioning complete output
4	At-speed output
5	Torque limiting signal
6	Zero-speed detection output
7	Velocity coincidence output

8	Positional command ON/OFF output
9	Speed limit signal output
10	Speed command ON/OFF output

7.4.2 Motor Rotation Direction

The Rotation Direction is defined in 607Eh.

Mode		Value
Position mode	PP	0: Rotate in the same direction as the position command 128: Rotate in the opposite direction as the position command
	HM	
	CSP	
Velocity mode	PV	0: Rotate in the same direction as the position command 64: Rotate in the opposite direction as the position command
	CSV	
Torque mode	PT	0: Rotate in the same direction as the position command 32: Rotate in the opposite direction as the position command
	CST	
ALL mode		0: Rotate in the same direction as the position command 224: Rotate in the opposite direction as the position command

7.4.3 Drive Stop

If the 6085h is not 0, the 6085h object will be used as the deceleration speed for quick stop. If the 6085h is 0, the servo will be stopped quickly according to the maximum current limit.

The emergency stop when meet limit switch, motor will stop rapidly according to the maximum current limit.

When the state machine is switched to an enable state the motor will stop freely.

When bit8(Halt) of 6040h is 1, the motor will stop with deceleration set in 6083h/6084h.

7.4.4 Electronic Gear Ratio

EL7-EC position mode consists of cyclic synchronous position mode (CSP), protocol position mode (PP) and homing mode (HM), only in these three modes does the electronic gear ratio valid.

Electronic gear ratio range is 1/1000~8000, otherwise Er A00 warning will appear (the warning is not saved, after modification to a reasonable range, the operation panel alarm will automatically disappear, but the 402 state will still be in the "error" state, write 0x80 into 6040h.

The electronic gear ratio setting is defined by 608Fh(Position encoder resolution),6091h(Gear ratio) and 6092h(Feed constant), which can only be effectively changed in the pre-operational state.

608Fh(Position encoder resolution) is the resolution of the encoder, which is read internally without additional setting. 6092h_01 represents the number of pulses that can be set for each rotation of the motor. 6091h_01/6091h_02 is real-time update effective.

The electronic gear subdivision method can be determined by modifying 6092h_01(Feed constant)

The subdivision method of electronic gear can be determined by modifying 6092h_01(Feed constant) .

1、 If 6092h_01(Feed constant) is not equal to 608Fh(Position encoder resolution), then:

$$\text{Electronic gear ratio} = \text{encoder resolution} / 6092h_01$$

2、 If 6092h_01(Feed constant) is equal to 608Fh(Position encoder resolution), then:

$$\text{Electronic gear ratio} = 6091_01/6092h_01$$

Electronic gear ratio range is 1/1000~8000.

Note: when the setting value exceeds this range, the error will be reported and automatically reset to the default value. The default values of 6091_01, 6091_02 and 6092_01 are 1, 1 and 10000.

7.4.5 Position Limits

The hardware limit is valid in all operation modes, and the software limit is valid only in the absolute operation mode of cyclic synchronous position mode (CSP) and profile position mode (PP)

The limit of the software is defined by 607Dh. The maximum position in the negative direction is defined in 607d-01h and the maximum position in the positive direction is defined in 607d-02h, the unit are consistent with the instruction unit. These settings are not supported for saving into NVM.

The setting of object dictionary 0x5012-04 not only affects the homing offset of 607C, but also affects the software limit, 607D needs to be modified before the operational state

5012-04		Actural Positive Position Limit	Actural Negative Position Limit
Bit2	Bit3		
0	0	607D-02 + 607C	607D-01 + 607C
0	1	607D-02 - 607C	607D-01 - 607C
1	X	607D-02	607D-01

EL7-EC Software position limit valid conditions:

- A、 It can only be set in the pre-operational state of ESM. It is recommended to configure it by SDO when the system starts.
- B、 Only in the absolute mode of CSP and PP, in CSP mode, it is recommended to use the software limit function of the master station to achieve the fastest limit performance.
- C、 The incremental encoder motor is not effective until the homing process completed.
- D、 The setting rule is 607d-01h < 607d-02h, that is, the negative position limit value is less than the positive position limit value.

7.4.6 Control Word

Bit definition of Control Word 6040h.

Bit	15~11	10~9	8	7	6~4	3	2	1	0
Definition	-	-	Halt	Fault reset	Related to modes	Operation enable	Quick stop	Voltage output	Switch on

Command	Bit7 and Bit0 to Bit3					6040 Value	402 State machine *1)
	7: Fault reset	3: Operation enable	2: Quick stop	1: Voltage output	0: Start		
Power off	0	×	1	1	0	0006h	2;6;8
Switch on	0	0	1	1	1	0007h	3*
Switch on	0	1	1	1	1	000Fh	3**
No voltage outout	0	×	×	0	×	0000h	7;9;10;12

Quick stop	0	×	0	1	×	0002h	7;10;11
Operation disable	0	0	1	1	1	0007h	5
Operation enable	0	1	1	1	1	000Fh	4;16
Fault reset	Rising edge	×	×	×	×	0080h	15

× is not affected by this bit state

* indicates that this transition is performed in the device start state

** indicates that it has no effect on the start state and remains in the start state

*1) The state machine switch corresponds to figure 7.1

The definition of bit 8 and bit 6~4 in different operation modes are shown in the following table

Bit	Operation Mode						
	Profile Position (PP)	Profile Velocity (PV)	Profile Torque (PT)	Homing (HM)	Cyclic Sync Position (CSP)	Cyclic Sync Velocity (CSV)	Cyclic Sync Torque (CST)
8	Stop with deceleration	Stop with deceleration	Stop with deceleration	Stop with deceleration	-	-	-
6	Absolute/Increment	-	-	-	-	-	-
5	Immediately trigger	-	-	-	-	-	-
4	New Position	-	-	Start	-	-	-

7.4.7 Status Word

Bit definition of Status Word 6041h.

Bit	Definition
15~14	Reserved
13~12	Related to modes
11	Position limit valid
10	Position arrival
9	Distance
8	Related to modes
7	Reserved
6	Not switch on
5	Quick stop
4	Voltage output
3	Fault
2	Operation enable
1	Switch on
0	Ready to switch on

Bit 11 is valid when the software or hardware limit is in effect.

The combination of bit 6 and bit 3~0 represents the device state shown in following table

Combination of bit 6 and bit 3~0	Description
xxxx,xxxx,x0xx,0000	Not ready to switch on
xxxx,xxxx,x1xx,0000	Switch on disabled
xxxx,xxxx,x01x,0001	Ready to switch on
xxxx,xxxx,x01x,0011	Switch on
xxxx,xxxx,x01x,0111	Operation enabled
xxxx,xxxx,x00x,0111	Quick stop active
xxxx,xxxx,x0xx,1111	Fault reaction active
xxxx,xxxx,x0xx,1000	Fault

x is not affected by this bit state

The definition of bit 8 and bit 13~12 in different operation modes are shown in the following table

Bit	Operation Mode						
	Profile Position (PP)	Profile Velocity (PV)	Profile Torque (PT)	Homing (HM)	Cyclic Sync Position (CSP)	Cyclic Sync Velocity (CSV)	Cyclic Sync Torque (CST)
13	Position error is too large	-	-	Homing Process error	-	-	-
12	-	Velocity is 0	-	Homing Process completed	Following valid	Following valid	Following valid
8	Abnormal stop	-	-	Abnormal stop	Abnormal stop	-	-

7.4.8 Drive Enable

This section describes how to enable the drive by control word (6040h), how to view the drive enable states by status word (6041h)

Steps:

- 1: Write 0 to the control word 6040h, and then AND 0x250 by bit, whether it is equal to 0x250
- 2: Write 6 to the control word 6040h, and then AND 0x231 by bit, whether it is equal to 0x231
- 3: Write 7 to the control word 6040h, and then AND 0x233 by bit, whether it is equal to 0x233
- 4: Write 15 to the control word 6040h, and then AND 0x237 by bit, whether it is equal to **0x1237**

7.4.9 Communication Cycle

The synchronization cycle of EL7-EC supported by the 250us integer multiplier relation in the range of 250us~10ms. The minimum and maximum synchronization cycles can be set, the minimum can be set as 125us and the maximum parameters can be set as 20ms.

7.5 Position Mode (CSP, PP, HM)

7.5.1 Common Functions of Position Mode

Index	Sub-Index	Name	Units	Range	Data Type	Access	PDO	Mode		
								PP	CSP	HM
6040	0	Control word		0 - 65535	U16	rw	RxPDO			
6072	0	Max torque	0.1 %	0 - 65535	U16	rw	RxPDO			
607A	0	Target position	Command unit	-2147483648 -2147483647	I32	rw	RxPDO			
607D	1	Minimum soft limit	Command unit	-2147483648 -2147483647	I32	rw	RxPDO			
	2	Maximum soft limit	Command unit	-2147483648 -2147483647	I32	rw	RxPDO			
607F	0	Maximum protocol speed (Restricted by 6080)	Command unit /s		U32	rw	RxPDO			
6080	0	Maximum motor speed	r/min		U32	rw	RxPDO			
6081	0	Profile speed (Restricted by 607F)	Command unit /s		U32	rw	RxPDO			
6083	0	Profile acceleration	Command unit /s/s		U32	rw	RxPDO			
6084	0	Profile deceleration	Command unit /s/s		U32	rw	RxPDO			
60C5	0	Protocol maximum acceleration	Command unit /s/s		U32	rw	RxPDO			
60C6	0	Protocol maximum deceleration	Command unit /s/s		U32	rw	RxPDO			

Index	Sub-Index	Name	Units	Range	Data Type	Access	PDO	Mode		
								PP	CSP	HM
6041	0	Status word	-							
6062	0	Position demand value	Command unit							
6063	0	Actual internal position value	Encoder unit							
6064	0	Actual feedback position value	Command unit							
6065	0	Follow error	Command							

		window	unit							
6066	0	Follow error detection time	ms							
606C	0	Actual feedback speed value	Command unit							
6074	0	Internal torque command	0.001							
6076	0	Rated torque	mN.M							
6077	0	Actual torque	0.1%							
60F4	0	Actual following error	Command unit							
60FA	0	Speed of position loop	Command unit /s							
60FC	0	Internal command position	Encoder unit							

7.5.2 Cyclic Synchronous Position Mode (CSP)

7.5.2.1 Block Diagram

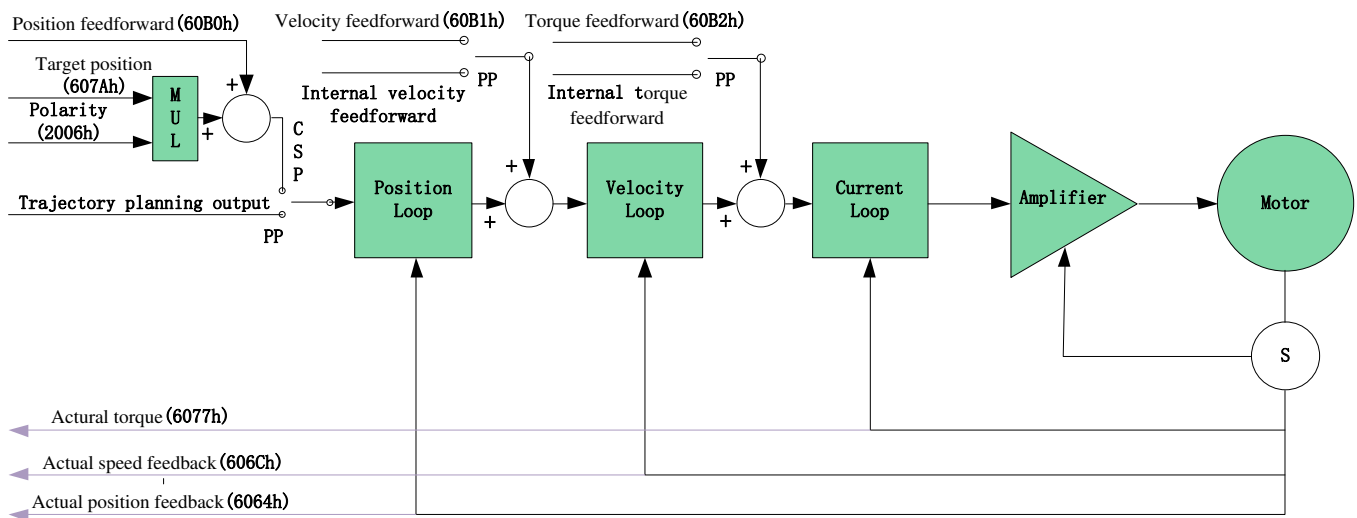

7.5.2.2 Related Objects

Basic object

PDO	Index+Sub-Index	Name	Data Type	Access	Unit	Notes
(RXPDO)	6040-00h	Control word	U16	RW	—	Required
	607A-00h	Target position	I32	RW	Uint	Required
	60B0-00h	Position feedforward	I32	RW	Uint	Optional
	60B1-00h	Velocity feedforward	I32	RW	Uint /S	Optional
	60B2-00h	Torque feedforward	I16	RW	0.1%	Optional

(TXPDO)	6041-00h	Status word	U16	RO	—	Required
	6064-00h	Actual position feedback value	I32	RO	Uint	Required
	606C-00h	Actual speed feedback value	I32	RO	Uint /S	Optional
	60F4-00h	Actual following error	I32	RO	Uint	Optional
	6077-00h	Actual torque	I16	RO	0.1%	Optional

Extended object

Index+Sub-Index	Name	Data Type	Access	Unit
603F-00h	Error code	U16	RO	—
6060-00h	Operation mode	I8	RW	—
6061-00h	Displayed operation mode	I8	RO	—
6062-00h	Position demand value	I32	RO	Uint
606B-00h	Internal command speed	I32	RO	Uint
607D-01h	Negative position soft limit	I32	RO	Uint
607D-02h	Positive position soft limit	I32	RO	Uint
605A-00h	Quick stop option code	I16	RW	—
6085-00h	Quick stop deceleration	U32	RW	Uint /S
608F-01h	Encoder resolution	U32	RO	P
608F-02h	Motor turns	U32	RO	—
6091-01h	Electron gear molecule	U32	RW	—
6091-02h	Electronic gear denominator	U32	RW	—
6092-01h	Number of pulses per rotation	U32	RW	—
6092-02h	Number of physical axis turns	U32	RO	—

This function can make position instruction smoother and motor rotation more stable.

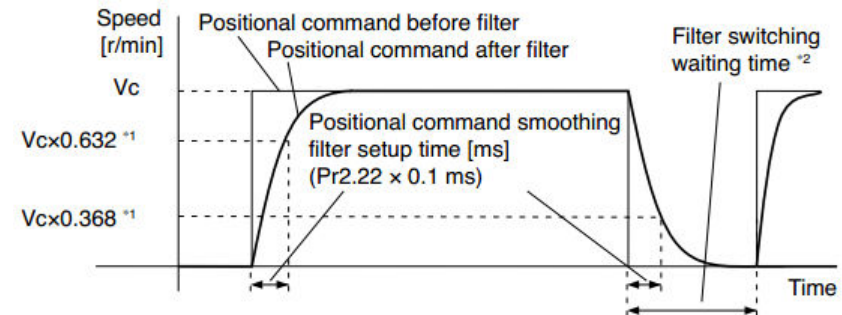
Pr2.22	Name	positional command smoothing filter			Mode	PP			H	CS		
	Range	0~32767	Unit	0.1ms	Default	0	Index		M	P		2222h
<ul style="list-style-type: none"> ● Set up the time constant of the 1st delay filter in response to the positional command. ● When a square wave command for the target speed V_c is applied ,set up the time constant of the 1st delay filter as shown in the figure below. 												
												

Pr2.23	Name	positional command FIR filter	Mode	PP			H	CS				
							M	P				

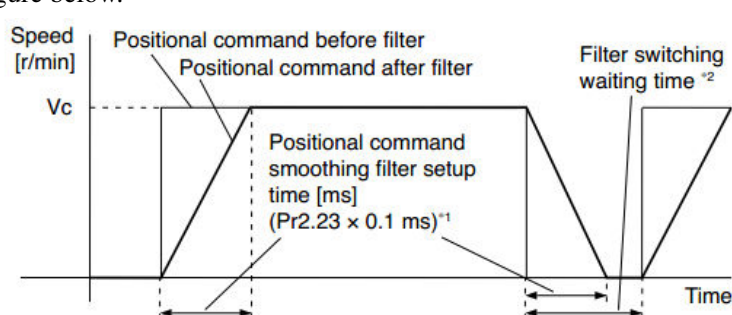
Range	0~10000	Unit	0.1ms	Default	0	Index	2223h
<ul style="list-style-type: none"> ● Set up the time constant of the 1st delay filter in response to the positional command. ● When a square wave command for the target speed V_c is applied, set up the V_c arrival time as shown in the figure below. 							
							

This function can be configured through IO output function parameters, refer to IO Pr4.10 parameter description. When the position error meets the set condition, the set corresponding output IO port can output ON

The position arrival signal of PP/HM mode is synchronized with the INP signal.

Pr4.31	Name	Positioning complete range		Mode	PP	H	M	CSP		
	Range	0~10000	Unit	Default	10	Index		2431h		
Set up the timing of positional deviation at which the positioning complete signal (INP1) is output.										

Pr4.32	Name	Positioning complete range		Mode	PP	H	M	CSP		
	Range	0~4	Unit	Default	0	Index		2432h		
Select the condition to output the positioning complete signal (INP1).										
Setup value		Action of positioning complete signal								
0		The signal will turn on when the positional deviation is smaller than Pr4.31 [positioning complete range].								
1		The signal will turn on when there is no position command and position deviation is smaller than Pr4.31 [positioning complete range].								
2		The signal will turn on when there is no position command, the zero-speed detection signal is ON and the positional deviation is smaller than Pr4.31 [positioning complete range].								
3		The signal will turn on when there is no position command and the positional deviation is smaller than Pr4.31 [positioning complete range]. Then holds "ON" states until the next position command is entered. Subsequently, ON state is maintained until Pr4.33 INP hold time has elapsed. After the hold time, INP output will be turned ON/OFF according to the coming positional command or condition of the positional deviation.								
4		When there is no command, the position determination starts after the delay time set by Pr4.33 The signal will turn on when there is no position command and positional deviation is smaller than Pr4.31 [positioning complete range]								

Pr4.33	Name	INP hold time		Mode	PP	H	M	CSP		

	Range	0~15000	Unit	1ms	Default	0	Index	2433h
Set up the hold time when Pr 4.32 positioning complete output setup=3.								
Setup value		State of Positioning complete signal						
0		The hold time is maintained definitely, keeping ON state until next positional command is received.						
1-15000		ON state is maintained for setup time (ms)but switched to OFF state as the positional command is received during hold time.						

7.5.3 Profile Position Mode (PP)

In asynchronous motion mode, the master station is only responsible for sending motion parameters and control commands. EL7-EC servo driver will conduct trajectory planning according to the motion parameters sent by the master station after receiving the motion start command from the master station. In asynchronous motion mode, the motion between each motor shaft is asynchronous.

7.5.3.1 Block Diagram

The difference between PP and CSP mode is that PP needs EL7-EC to have the function of track generator, so PP needs to add track generator in the entry part of track generation in figure 7.5. The input and output structure of the track generator is shown in figure 7.8

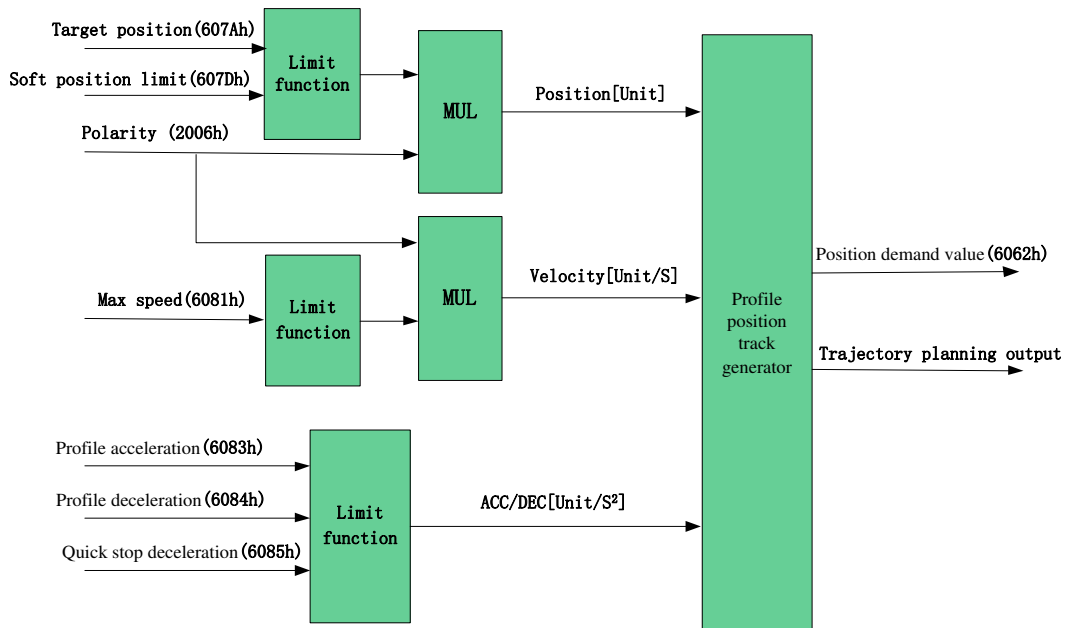

7.5.3.2 Related Objects

Basic object

PDO	Index+Sub-Index	Name	Data Type	Access	Unit	Notes
(RXPDO)	6040-00h	Control word	U16	RW	—	Required
	607A-00h	Target Position	I32	RW	Uint	Required
	6081-00h	Max speed	U32	RW	Uint	Required

	6083-00h	Acceleration	I32	RW	Uint /S	Optional
(TXPDO)	6041-00h	Status word	U16	RO	—	Required
	6064-00h	Position feedback	I32	RO	Uint	Required
	606C-00h	Speed feedback	I32	RO	Uint /S	Optional
	60F4-00h	Actual following error	I32	RO	Uint	Optional
	6077-00h	Actual torque	I16	RO	0.1%	Optional

Extended object

Index+Sub-Index	Name	Data Type	Access	Unit
603F-00h	Error code	U16	RO	—
6060-00h	Operation mode	I8	RW	—
6061-00h	Displayed operation mode	I8	RO	—
6062-00h	Position demand value	I32	RO	Uint
606B-00h	Internal command speed	I32	RO	Uint
607D-01h	Negative position soft limit	I32	RO	Uint
607D-02h	Positive position soft limit	I32	RO	Uint
605A-00h	Quick stop option code	I16	RW	—
6084-00h	Deceleration	U32	RW	Uint /S
6085-00h	Quick stop deceleration	U32	RW	Uint /S
608F-01h	Encoder resolution	U32	RO	P
608F-02h	Motor turns	U32	RO	—
6091-01h	Electron gear molecule	U32	RW	—
6091-02h	Electronic gear denominator	U32	RW	—
6092-01h	Number of pulses per rotation	U32	RW	—
6092-02h	Number of physical axis turns	U32	RO	—

7.5.3.3 Control Word and Status Word for Profile Position Mode

Control Word for Profile Position Mode

Table7. Bit6~4 of Control word (6040h) for Profile Position Mode

Bit (Name)	Value	Details
4 (New Position)	0→1	Start position movement with the latest target position (607Ah), maximum speed (6081h), ACC/DEC(6083h/6084h)
5 (Immediately trigger)	0	The new position motion cannot be triggered until the current position motion is completed.
	1	Interrupt the current position motion and start a new position motion immediately.
6 (Absolute/ Relative)	0	Absolute motion.
	1	Relative motion.

Table7. Bit5 of Control word (6040h) for Profile Position Mode

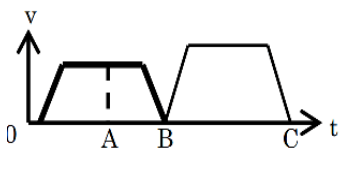
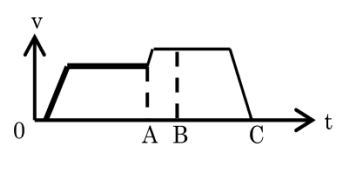
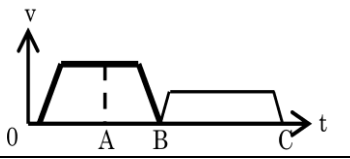
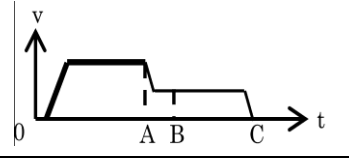
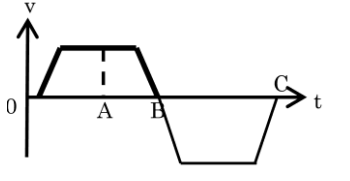
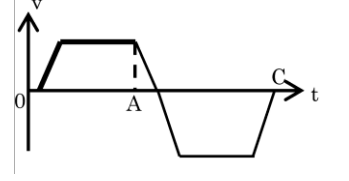
Bit 5	Bit 5 = 0	Bit 5 = 1
Update the target position in the same direction in the ACC/ constant speed		
Update the target position in the same direction in the DEC speed		
Update the target position in the opposite direction		

A: Command change time from host.

B: Target position (before update) arrival time.

C: Target position (updated) arrival time.

Status Word for Profile Position Mode

Table 7. Bit15~12,10,8 of Status word (6041h) for Profile Position Mode

Bit (Name)	Value	Details
8 (Abnormal stop)	0	Normal motion
	1	Abnormal stop *1)
10 (Position arrival)	0	Position not finish yet
	1	Position arrival
12 (Response to new position)	0	Current movement completed/can be interrupt, new target position can be updated *2)
	1	Current movement incomplete/can not be interrupt, new target position cannot be updated
14 (Motion parameters)	0	The motion parameters are valid and none of the necessary parameters are 0
	1	The necessary parameter is 0, the maximum velocity (6081h), acceleration (6083h) and deceleration (6084h) have at least one parameter of 0
15 (Trigger response)	0	Current movement incomplete/can not be interrupt, new target position cannot be updated
	1	Current movement completed/can be interrupt, new target position can be updated

*1) Abnormal stop of bit 8 is generally effective when hardware limit, deceleration stop and quick stop valid.

*2) Bit 12 of 6041h will reset to 0 when bit5=1 (6040h) and bit4=0 (6040h) (Such as 6040h = 0x2F/4F), switch to can be interrupt state.

7.5.3.4 Example of Relative Position Control

Steps:

- 1: Setup Operation mode 6060h =1, check whether 6061h =1, make sure the drive has changed to PP mode.
- 2: Setup target position 607Ah, max speed 6081h, acceleration 6083h and deceleration 6084h.
- 3: In enable status, setup bit6=1 (6040h) and bit4=1 (6040h) to trigger relative position control.

7.5.4 Homing Mode (HM)

7.5.4.1 Block Diagram

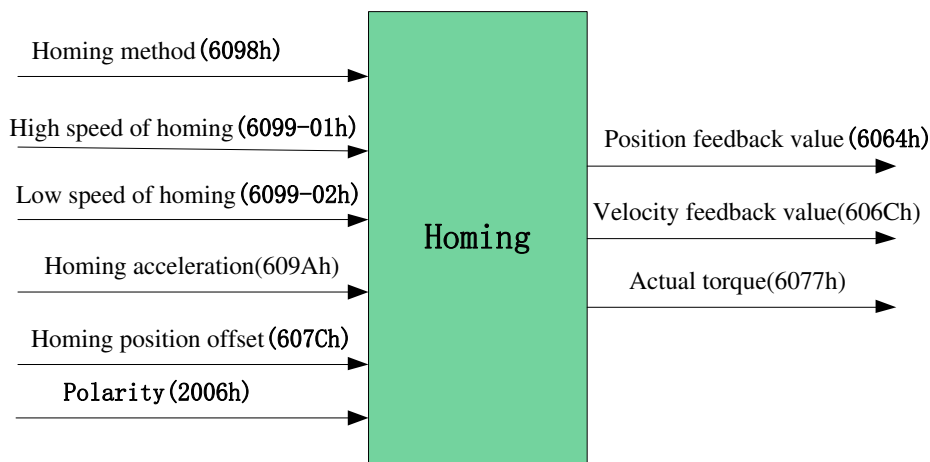

7.5.4.2 Related Objects

Basic object

PDO	Index+Sub-Index	Name	Data Type	Access	Unit
(RXPDO)	6040-00h	Control word	U16	RW	—
	6098-00h	Target torque	I8	RW	—
	6099-01h	High speed of homing	U32	RW	Uint /S
	6099-02h	Low speed of homing	U32	RW	Uint /S
	609A-00h	Homing acceleration	U32	RW	Uint /S ²
	607C-00h	Homing position offset	I32	RW	Uint
(TXPDO)	6041-00h	Status word	U16	RO	—
	6064-00h	Position feedback value	I32	RO	Uint
	606C-00h	Velocity feedback value	I32	RO	Uint /S
	60F4-00h	Actual following error	I32	RO	Uint
	6077-00h	Actual torque	I16	RO	0.1%

Extended object

Index+Sub-Index	Name	Data Type	Access	Unit
-----------------	------	-----------	--------	------

603F-00h	Error code	U16	RO	—
6060-00h	Operation mode	I8	RW	—
6061-00h	Displayed operation mode	I8	RO	—
6062-00h	Position demand value	I32	RO	Uint
606B-00h	Internal command speed	I32	RO	Uint
608F-01h	Encoder resolution	U32	RO	P
608F-02h	Motor turns	U32	RO	—
6091-01h	Electronic gear molecule	U32	RW	—
6091-02h	Electronic gear denominator	U32	RW	—
6092-01h	Number of pulses per rotation	U32	RW	—
6092-02h	Number of physical axis turns	U32	RO	—

7.5.4.3 Control Word and Status Word for Homing Mode

Control Word for Homing Mode

Table7. Bit6~4 of Control word (6040h) for Homing Mode

Bit (Name)	Value	Details
4 (Homing start/stop)	0 → 1	Homing start
	1 → 0	Homing stop
5 (Reserved)	0	
	1	
6 (Reserved)	0	
	1	

Status Word for Homing Mode

Table7. Bit15~12、10、 8 of Status word (6041h) for Homing Mode

Bit (Name)	Value	Details
8 (Abnormal stop)	0	Normal motion
	1	Abnormal stop *1)
10 (Position arrival)	0	Position not finish yet
	1	Position arrival
12 (Homing finish)	0	Homing not finish yet
	1	Homing finished, Bit12 will setup to 1 after Bit10 setup to 1 *2)
13 (Homing error)	0	No homing error
	1	Homing timeout or deviation excessive
14 (Motion parameters)	0	The motion parameters are valid and none of the necessary parameters are 0
	1	The necessary parameter is 0, the maximum velocity (6081h), acceleration (6083h) and deceleration (6084h) have at least one parameter of 0

15 (Trigger response)	0	Homing process have been triggered/finished
	1	Homing process can be triggered

*1) Abnormal stop of bit 8 is generally effective when hardware limit, deceleration stop and quick stop valid.

*2) To check whether the homing process is complete, it is necessary to check whether bits 10 and 12 are all set.

7.5.4.4 Homing Method

Method -6: Search the homing point with low speed negative direction, when the torque reached then stop immediately.

● Start Position ■ Stop Position → Low speed of homing 6099h-02h

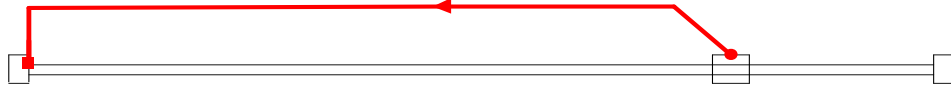

Method -5: Search the homing point with low speed positive direction, when the torque reached then stop immediately.

● Start Position ■ Stop Position → Low speed of homing 6099h-02h

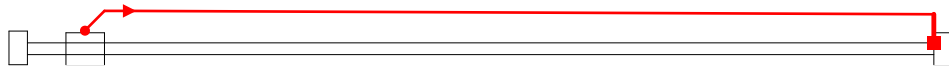

Method -4: Search the homing point with low speed negative direction, when the torque reached then change the motion direction, when the torque is gone then stop immediately.

● Start position ■ Stop Position → High speed 6099h-01h → Low speed 6099h-02h

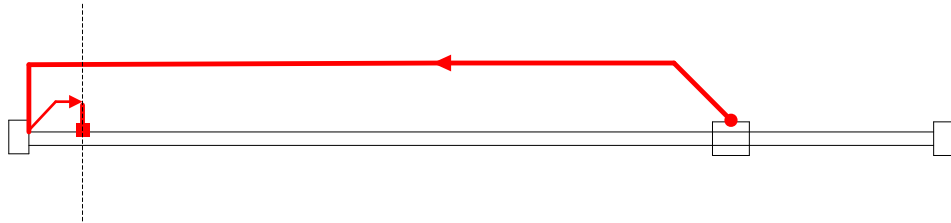

Method -3: Search the homing point with low speed positive direction, when the torque reached then change the motion direction, when the torque is gone then stop immediately.

● Start Position ■ Stop Position → High speed 6099h-01h → Low speed 6099h-02h

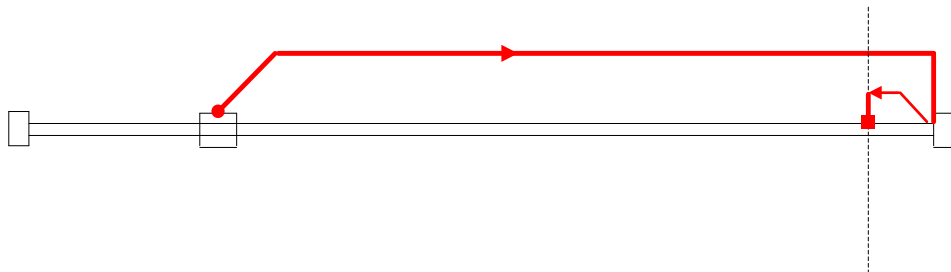

Method -2: Search the homing point with low speed negative direction, when the torque reached then reverse the direction, when the torque is gone and Z signal coming then stop immediately.

● Start Position ■ Stop Position → High speed 6099h-01h → Low speed 6099h-02h

Z signal 

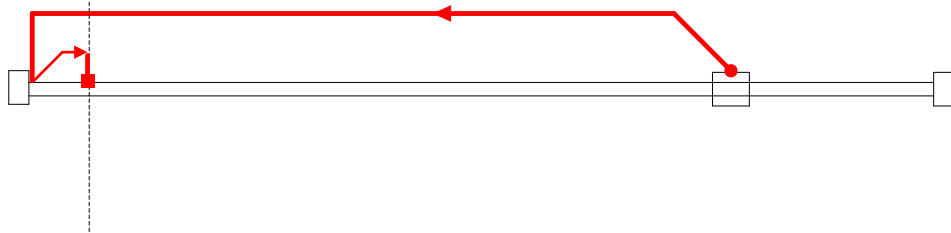

Method -1: Search the homing point with low speed positive direction, when the torque reached then reverse the direction, when the torque is gone and Z signal coming then stop immediately.

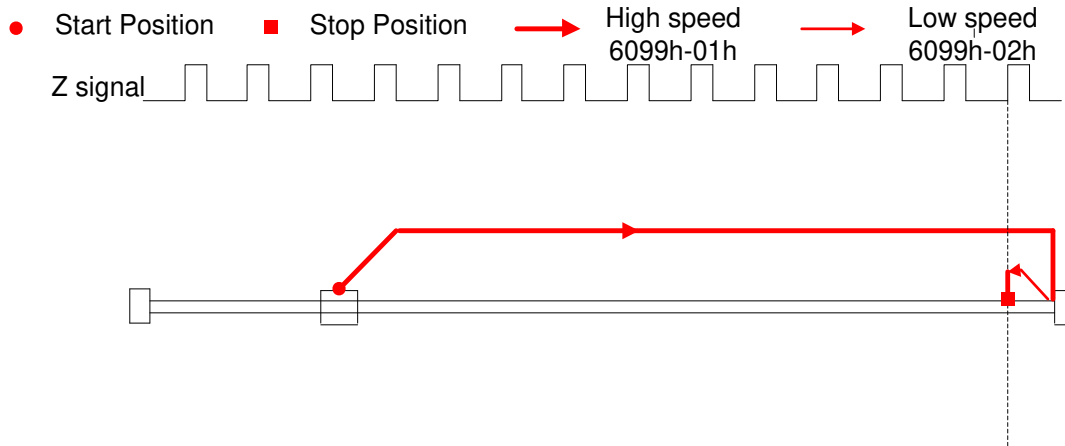

Method 1:

If the negative limit switch is invalid, the motor will move in negative direction at high speed until the negative limit switch signal is valid. The motor stops and starts moving at low speed in positive direction. The motor stops after leaving the negative limit switch and the first encoder Z signal is valid, as shown in figure.

If the motor stops at the negative limit position when it starts to move, the motor will move in positive direction at low speed. The motor stops after leaving the negative limit switch and the first encoder Z signal is valid, as shown in figure.

If the positive limit signal is valid during the homing process, the status word (6041h) bit 13 will be valid, indicating that the homing error and the motor will stop immediately.

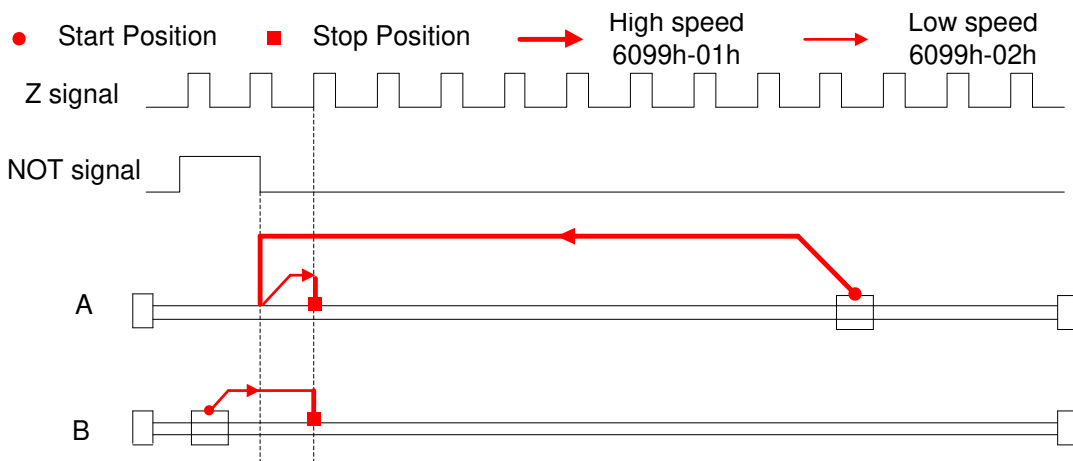

Method 2:

If the positive limit switch is invalid, the motor will move in positive direction at high speed until the positive limit switch signal is valid. The motor stops and starts moving at low speed in negative direction. The motor stops after leaving the positive limit switch and the first encoder Z signal is valid, as shown in figure.

If the motor stops at the positive limit position when it starts to move, the motor will move in negative direction at low speed. The motor stops after leaving the positive limit switch and the first encoder Z signal is valid, as shown in figure.

If the negative limit signal is valid during the homing process, the status word (6041h) bit 13 will be valid, indicating that the homing error and the motor will stop immediately.

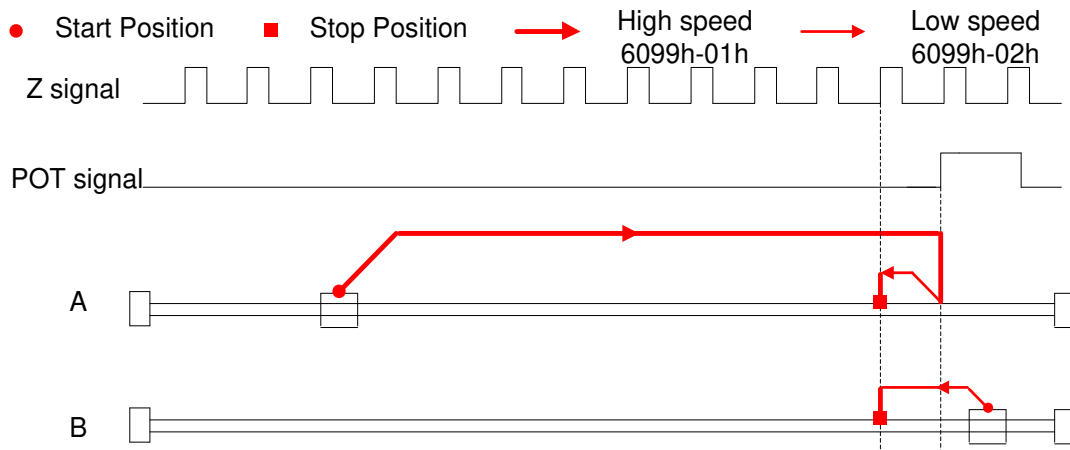
Method 3:

If the homing switch is invalid, the motor will move in positive direction at high speed until the homing switch signal is valid. The motor stops and starts moving at low speed in negative direction. The motor stops after leaving the homing switch and the first encoder Z signal is valid, as shown in figure.

If the motor stops at the homing switch position when it starts to move, the motor will move in negative direction at low speed. The motor stops after leaving the homing switch and the first encoder Z signal is valid, as shown in figure.

If the positive/negative limit switch signal is valid during the homing process, the status word (6041h) bit 13 will be valid, indicating that the homing error and the motor will stop immediately.

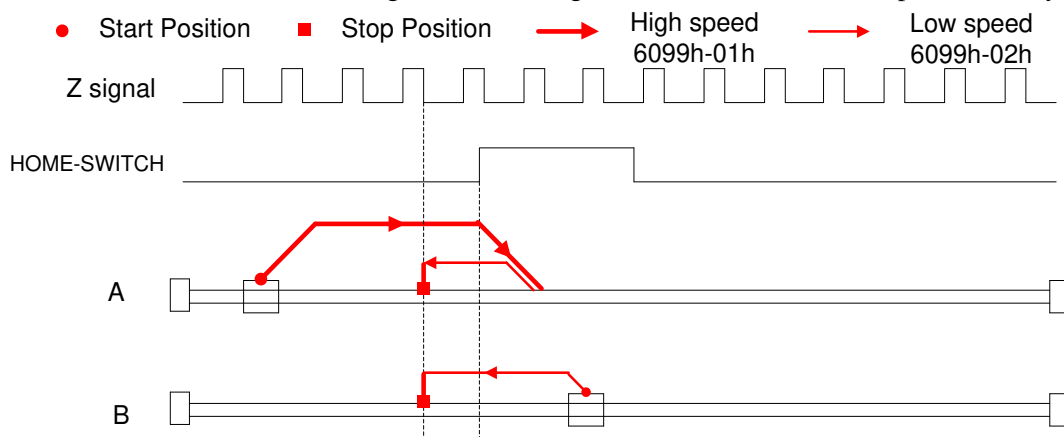

Method 4:

If the homing switch is invalid, the motor will move in positive direction at low speed until the homing switch signal is valid. The motor stops after leaving the homing switch and the first encoder Z signal is valid, as shown in figure.

If the motor stops at the homing switch position when it starts to move, the motor will move in negative direction at high speed until the homing switch invalid. Then the motor reverse the direction at low speed. The motor stops after the homing switch valid and the first encoder Z signal is valid, as shown in figure.

If the positive/negative limit switch signal is valid during the homing process, the status word (6041h) bit 13 will be valid, indicating that the homing error and the motor will stop immediately.

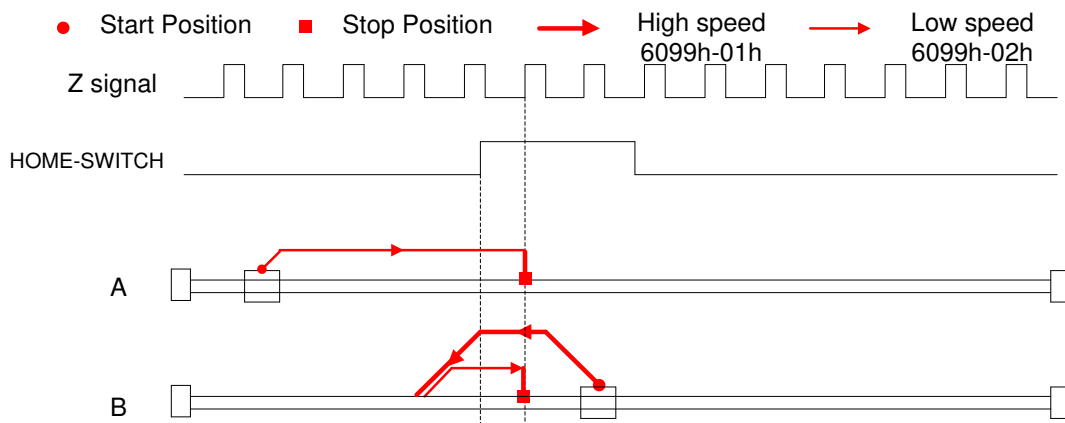
Method 5:

If the homing switch is invalid, the motor will move in negative direction at high speed until the homing switch signal is valid. Then the motor reverse the direction at low speed. The motor stops after leaving the homing switch and the first encoder Z signal is valid, as shown in figure.

If the motor stops at the homing switch position when it starts to move, the motor will move in positive direction at low speed. The motor stops after the homing switch invalid and the first encoder Z signal is valid, as shown in figure.

If the positive/negative limit switch signal is valid during the homing process, the status word (6041h) bit 13 will be valid, indicating that the homing error and the motor will stop immediately.

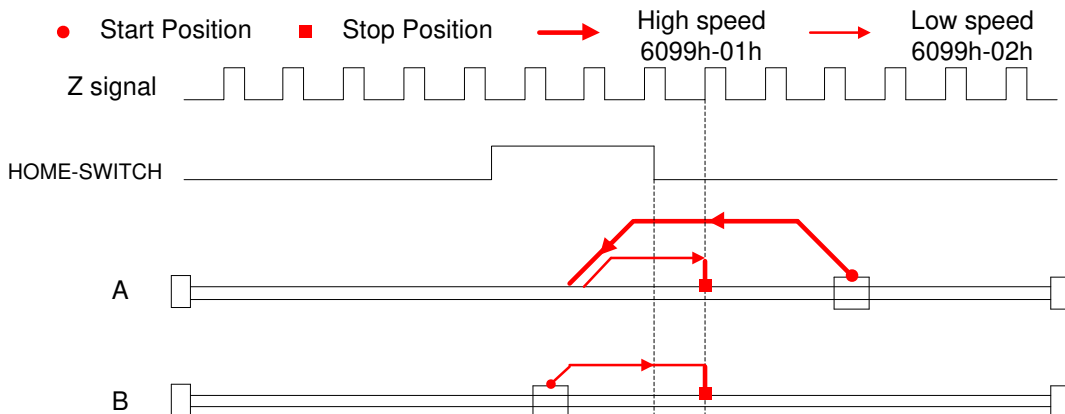

Method 6:

If the homing switch is invalid, the motor will move in negative direction at low speed until the homing switch signal is valid. The motor stops after leaving the homing switch and the first encoder Z signal is valid, as shown in figure.

If the motor stops at the homing switch position when it starts to move, the motor will move in positive direction at high speed until the homing switch invalid. Then the motor reverse the direction at low speed. The motor stops after the homing switch valid and the first encoder Z signal is valid, as shown in figure.

If the positive/negative limit switch signal is valid during the homing process, the status word (6041h) bit 13 will be valid, indicating that the homing error and the motor will stop immediately.

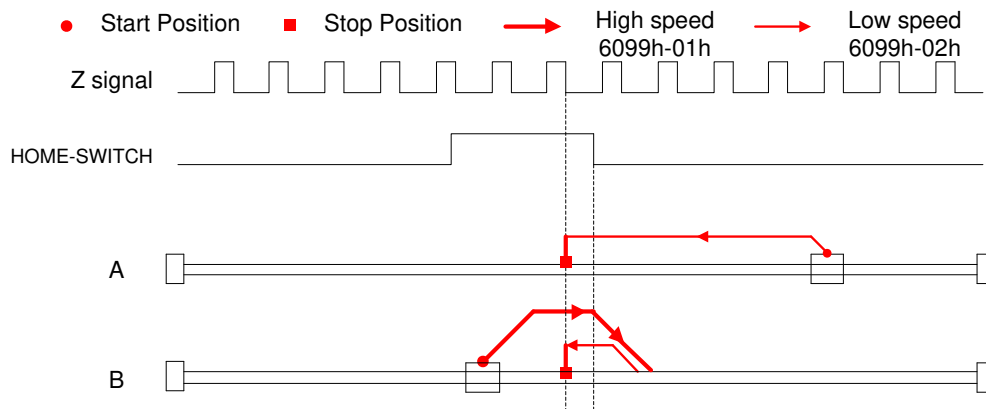

Method 7:

If the homing switch and positive limit switch is invalid, the motor will move in positive direction at high speed until the homing switch signal is valid. Then the motor reverse the direction at low speed. The motor stops after leaving the homing switch and the first encoder Z signal is valid, as shown in figure.

If the positive limit switch is invalid and motor stops at the homing switch position when it starts to move, the motor will move in negative direction at low speed until the homing switch signal is valid. The motor stops after leaving the homing switch and the first encoder Z signal is valid, as shown in figure.

If the homing switch and positive limit switch is invalid, the motor will move in positive direction at high speed until the positive limit switch valid. Then the motor reverse the direction at low speed. The motor stops after the homing switch valid and the first encoder Z signal is valid, as shown in figure.

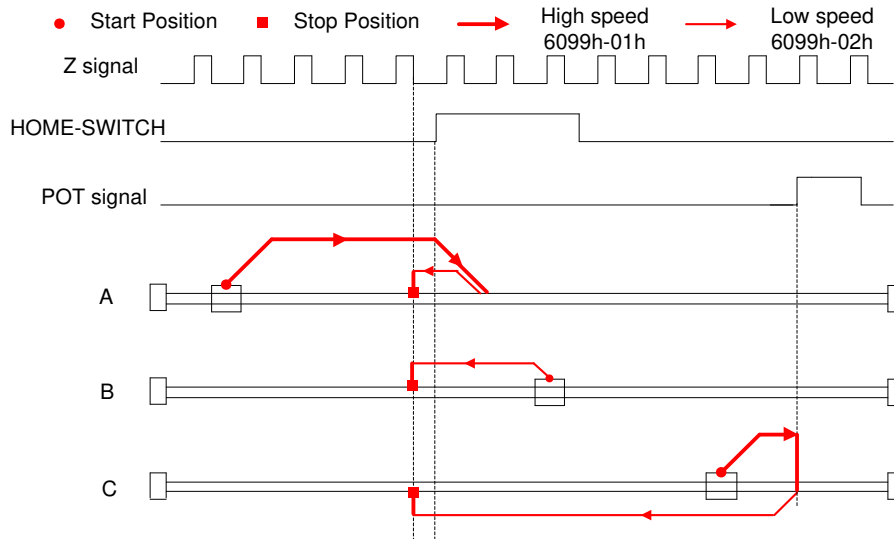
If the negative limit switch signal is valid during the homing process, the status word (6041h) bit 13 will be valid, indicating that the homing error and the motor will stop immediately.



Method 8:

If the homing switch and positive limit switch is invalid, the motor will move in positive direction at low speed. The motor stops after the homing switch valid and the first encoder Z signal is valid, as shown in figure.

If the positive limit switch is invalid and motor stops at the homing switch position when it starts to move, the motor will move in negative direction at high speed until the homing switch signal is invalid. Then the motor reverse the direction at low speed. The motor stops after the homing switch valid and the first encoder Z signal is valid, as shown in figure.

If the homing switch and positive limit switch is invalid, the motor will move in positive direction at low speed until the positive limit switch valid. Then the motor reverse the direction at high speed until the homing switch invalid. Then the motor move in positive direction at low speed. The motor stops after the homing switch valid and the first encoder Z signal is valid, as shown in figure.

If the negative limit switch signal is valid during the homing process, the status word (6041h) bit 13 will be valid, indicating that the homing error and the motor will stop immediately.

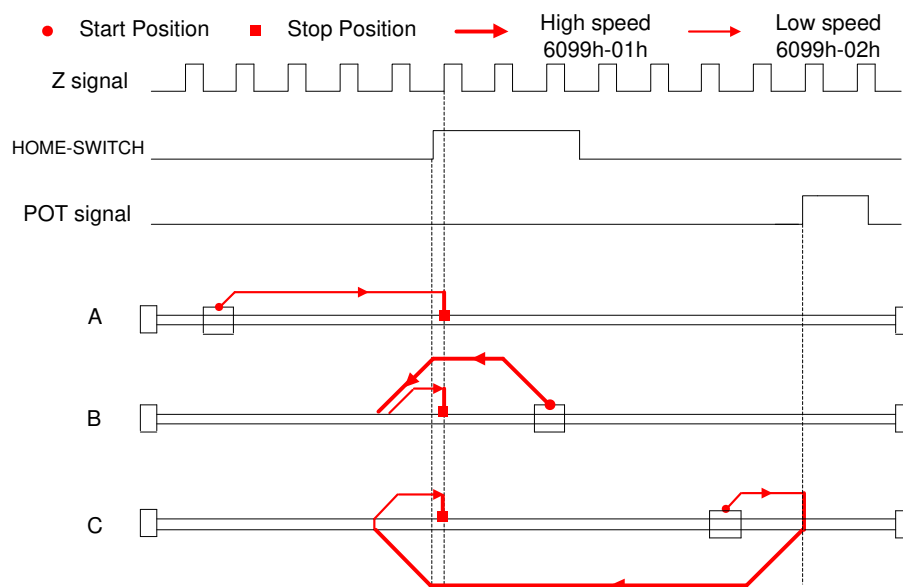

Method 9:

If the homing switch and positive limit switch is invalid, the motor will move in positive direction at high speed until the homing switch invalid. Then the motor reverse the direction at low speed. The motor stops after the homing switch valid and the first encoder Z signal is valid, as shown in figure.

If the positive limit switch is invalid and motor stops at the homing switch position when it starts to move, the motor will move in positive direction at high speed until the homing switch signal is invalid. Then the motor reverse the direction at low speed. The motor stops after the homing switch valid and the first encoder Z signal is valid, as shown in figure.

If the homing switch and positive limit switch is invalid, the motor will move in positive direction at high speed until the positive limit switch valid. Then the motor reverse the direction at low speed. The motor stops after the homing switch valid and the first encoder Z signal is valid, as shown in figure.

If the negative limit switch signal is valid during the homing process, the status word (6041h) bit 13 will be valid, indicating that the homing error and the motor will stop immediately.

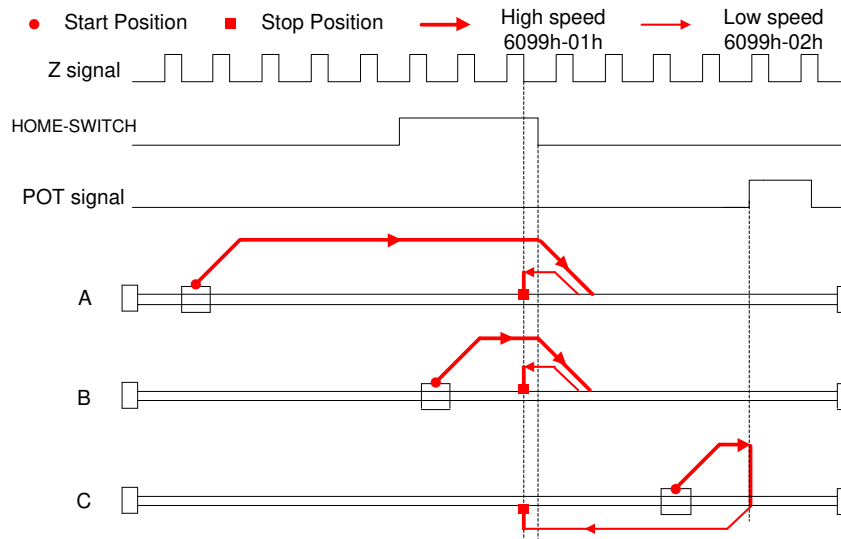
Method 10:

If the homing switch and positive limit switch is invalid, the motor will move in positive direction at low speed. The motor stops after the homing switch invalid and the first encoder Z signal is valid, as shown in figure.

If the positive limit switch is invalid and motor stops at the homing switch position when it starts to move, the motor will move in positive direction at low speed. The motor stops after the homing switch invalid and the first encoder Z signal is valid, as shown in figure.

If the homing switch and positive limit switch is invalid, the motor will move in positive direction at low speed until the positive limit switch valid. Then the motor reverse the direction at high speed until the homing switch valid. Then the motor move in positive direction at low speed. The motor stops after the homing switch invalid and the first encoder Z signal is valid, as shown in figure.

If the negative limit switch signal is valid during the homing process, the status word (6041h)

bit 13 will be valid, indicating that the homing error and the motor will stop immediately.

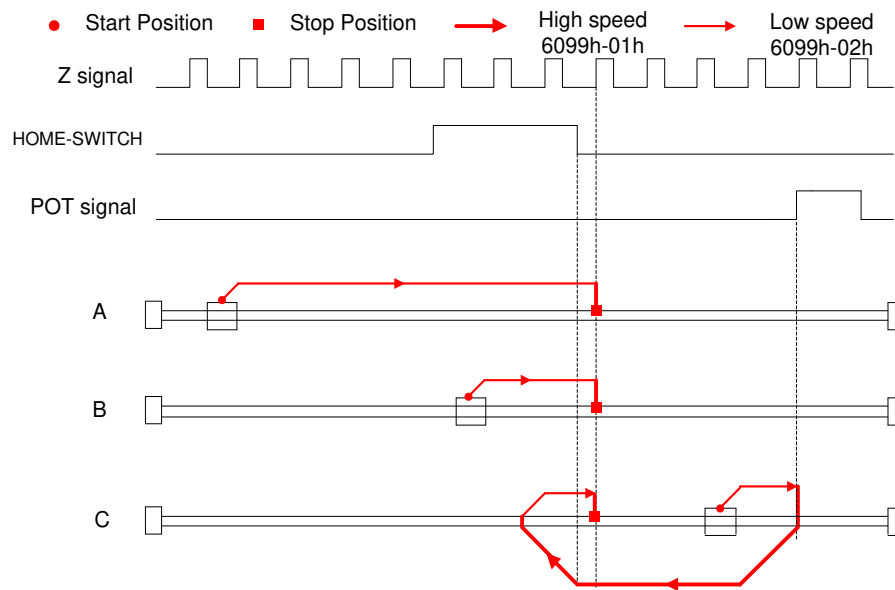

Method 11

If the homing switch and negative limit switch is invalid, the motor will move in negative direction at high speed until the homing switch signal is valid. Then the motor reverse the direction at low speed. The motor stops after leaving the homing switch and the first encoder Z signal is valid, as shown in figure.

If the negative limit switch is invalid and motor stops at the homing switch position when it starts to move, the motor will move in positive direction at low speed. The motor stops after leaving the homing switch and the first encoder Z signal is valid, as shown in figure.

If the homing switch and positive limit switch is invalid, the motor will move in negative direction at high speed until the negative limit switch valid. Then the motor reverse the direction at low speed. The motor stops after the homing switch invalid and the first encoder Z signal is valid, as shown in figure.

If the positive limit switch signal is valid during the homing process, the status word (6041h) bit 13 will be valid, indicating that the homing error and the motor will stop immediately.

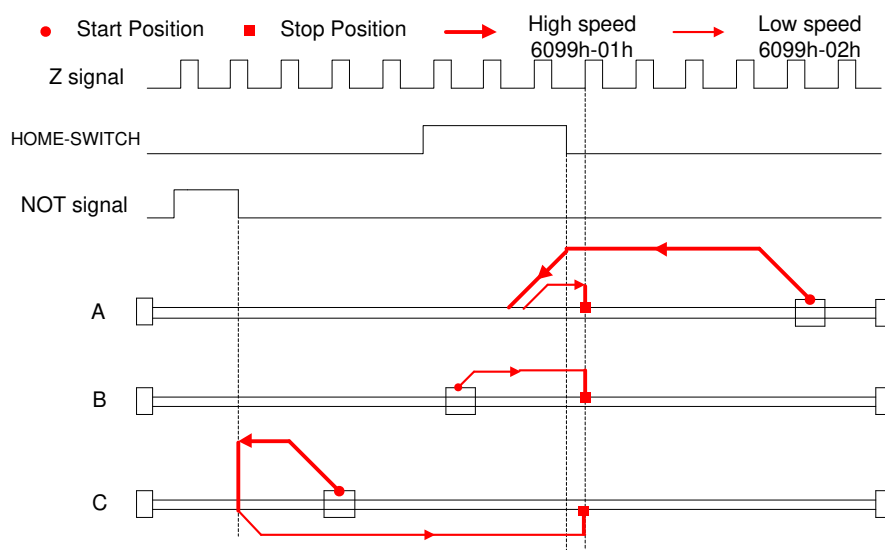

Method 12:

If the homing switch and positive limit switch is invalid, the motor will move in negative direction at low speed. The motor stops after the homing switch valid and the first encoder Z signal is valid, as shown in figure.

If the negative limit switch is invalid and motor stops at the homing switch position when it starts to move, the motor will move in positive direction at high speed until the homing switch signal is invalid. Then the motor reverse the direction at low speed. The motor stops after the homing switch valid and the first encoder Z signal is valid, as shown in figure.

If the homing switch and negative limit switch is invalid, the motor will move in negative direction at low speed until the positive limit switch valid. Then the motor reverse the direction at high speed until the homing switch invalid. Then the motor move in negative direction at low speed. The motor stops after the homing switch valid and the first encoder Z signal is valid, as shown in figure.

If the positive limit switch signal is valid during the homing process, the status word (6041h) bit 13 will be valid, indicating that the homing error and the motor will stop immediately.

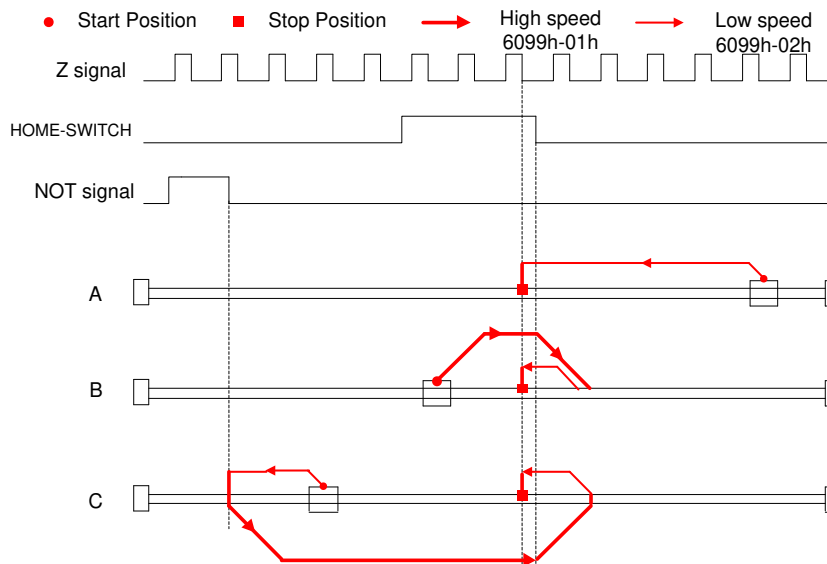
Method 13:

If the homing switch and negative limit switch is invalid, the motor will move in negative direction at high speed until the homing switch invalid. Then the motor reverse the direction at low speed. The motor stops after the homing switch valid and the first encoder Z signal is valid, as shown in figure.

If the negative limit switch is invalid and motor stops at the homing switch position when it starts to move, the motor will move in negative direction at high speed until the homing switch signal is invalid. Then the motor reverse the direction at low speed. The motor stops after the homing switch valid and the first encoder Z signal is valid, as shown in figure.

If the homing switch and positive limit switch is invalid, the motor will move in negative direction at high speed until the negative limit switch valid. Then the motor reverse the direction at low speed. The motor stops after the homing switch valid and the first encoder Z signal is valid, as shown in figure.

If the positive limit switch signal is valid during the homing process, the status word (6041h)

bit 13 will be valid, indicating that the homing error and the motor will stop immediately.

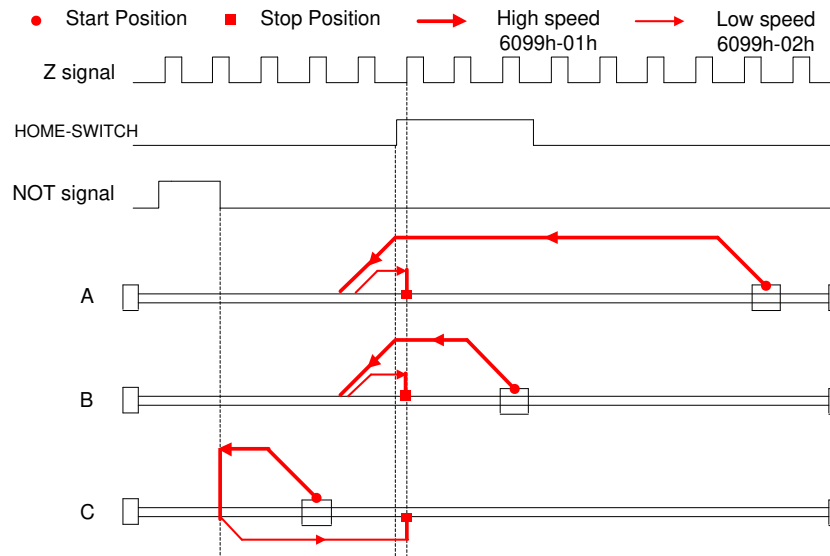

Method 14:

If the homing switch and positive limit switch is invalid, the motor will move in negative direction at low speed. The motor stops after the homing switch invalid and the first encoder Z signal is valid, as shown in figure.

If the negative limit switch is invalid and motor stops at the homing switch position when it starts to move, the motor will move in negative direction at low speed. The motor stops after the homing switch invalid and the first encoder Z signal is valid, as shown in figure.

If the homing switch and positive limit switch is invalid, the motor will move in negative direction at low speed until the negative limit switch valid. Then the motor reverse the direction at high speed until the homing switch valid. Then the motor move in negative direction at low speed. The motor stops after the homing switch invalid and the first encoder Z signal is valid, as shown in figure.

If the positive limit switch signal is valid during the homing process, the status word (6041h) bit 13 will be valid, indicating that the homing error and the motor will stop immediately.

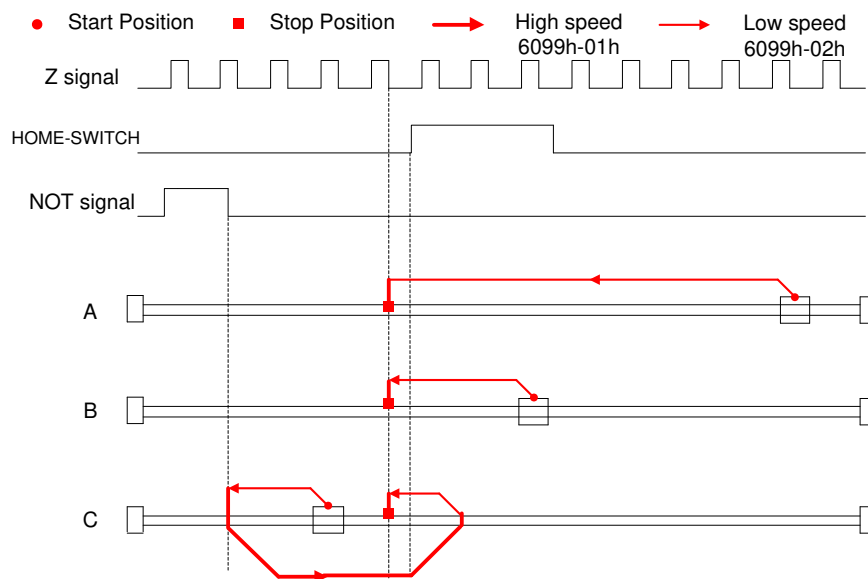

Method 17:

This method is similar to method 1

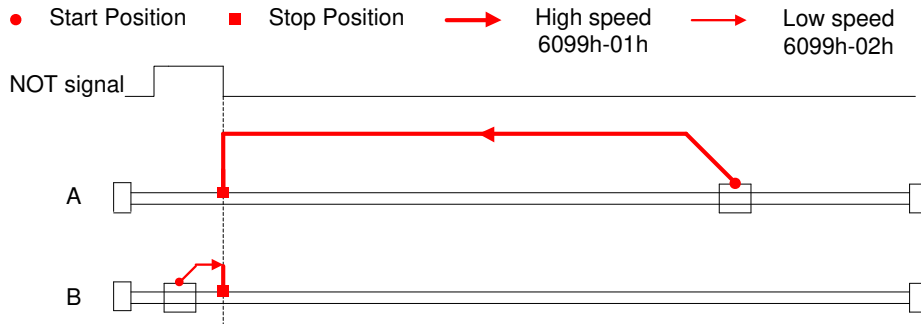
Method 18:

This method is similar to method 2

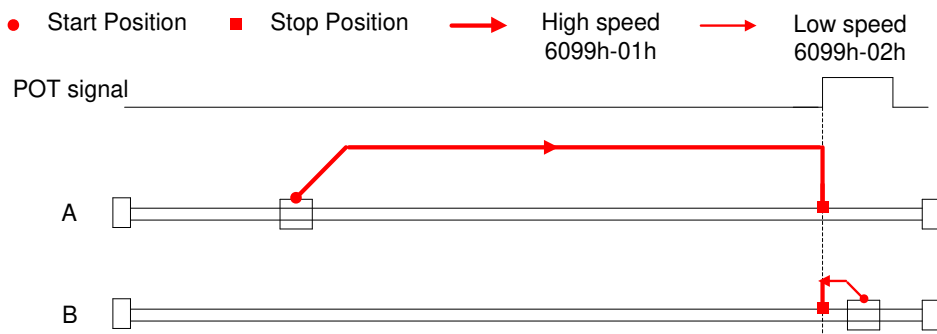
Method 19:

This method is similar to method 3

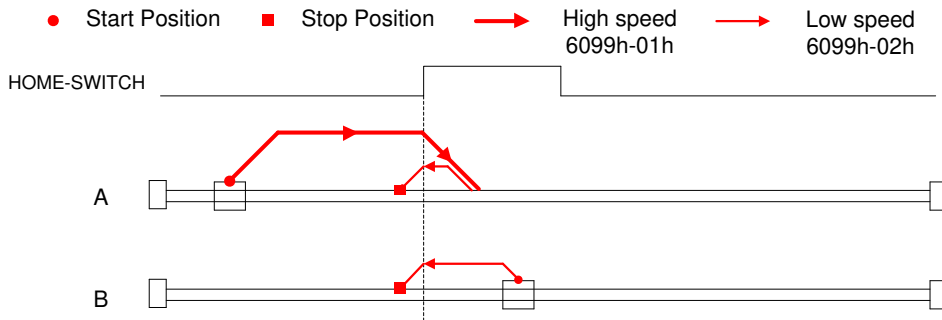

Method 20:

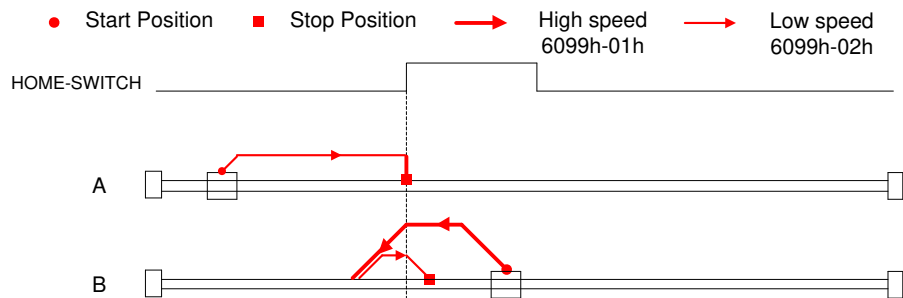
This method is similar to method 4

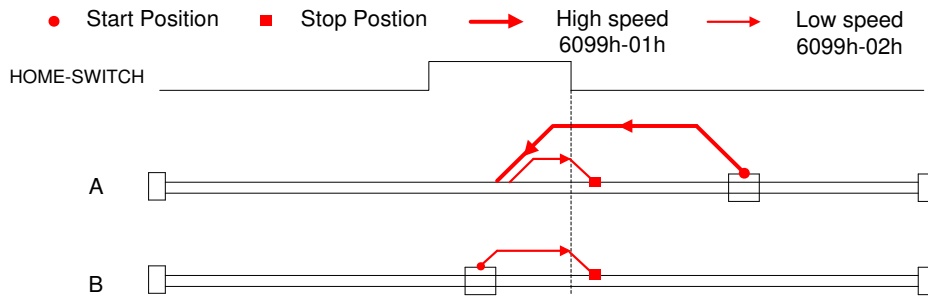

Method 21:

This method is similar to method 5

Method 22:

This method is similar to method 6

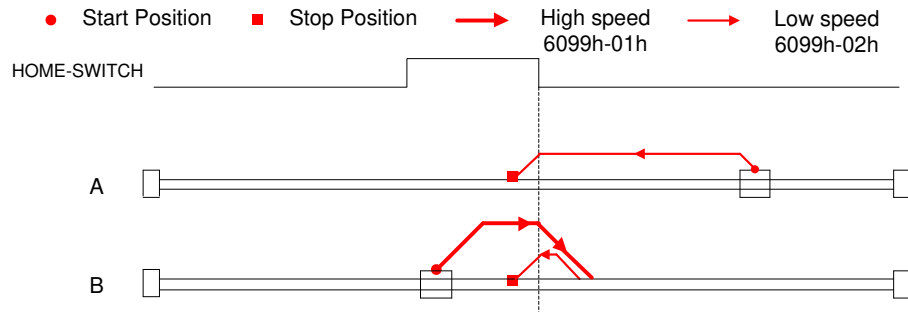
Method 23:

This method is similar to method 7

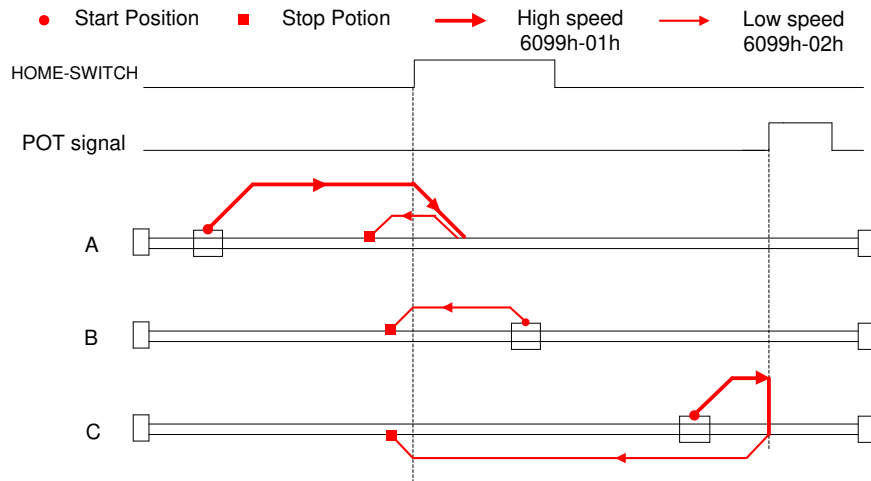

Method 24:

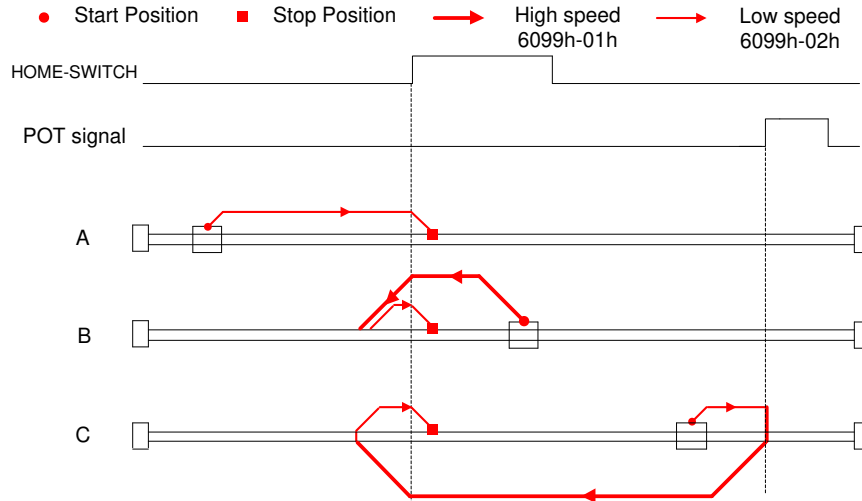
This method is similar to method 8

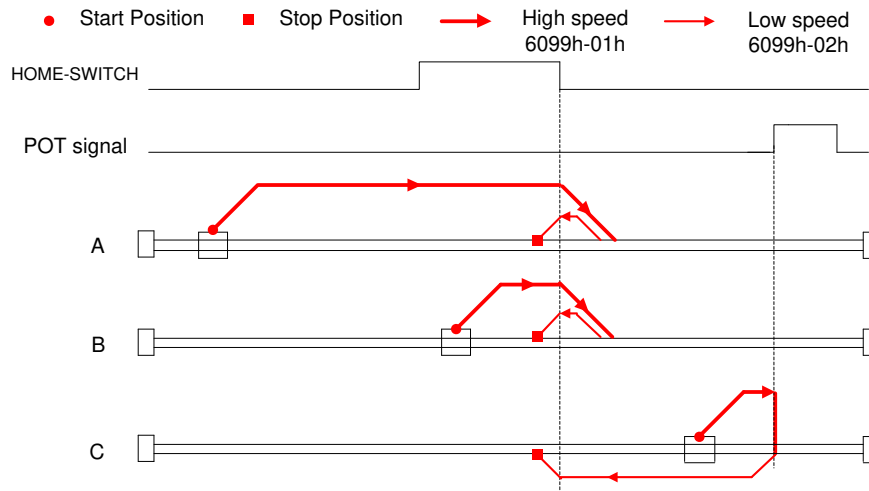

Method 25:

This method is similar to method 9



Method 26:

This method is similar to method 10

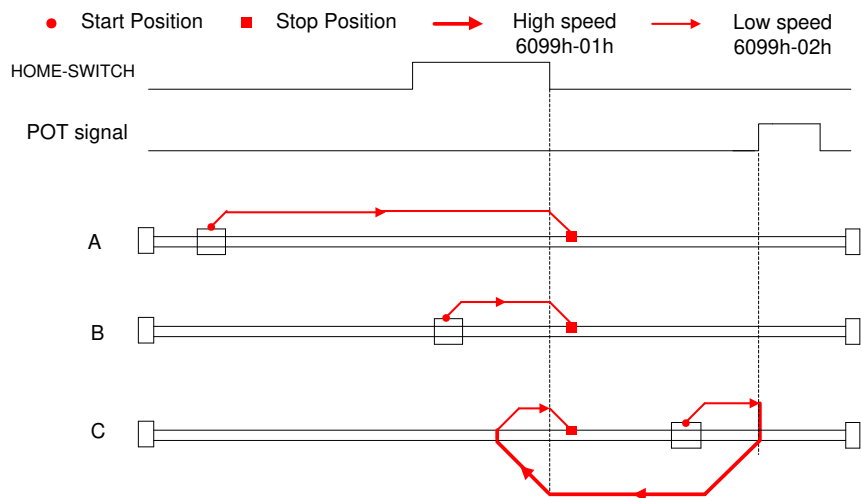

Method 27:

This method is similar to method 11

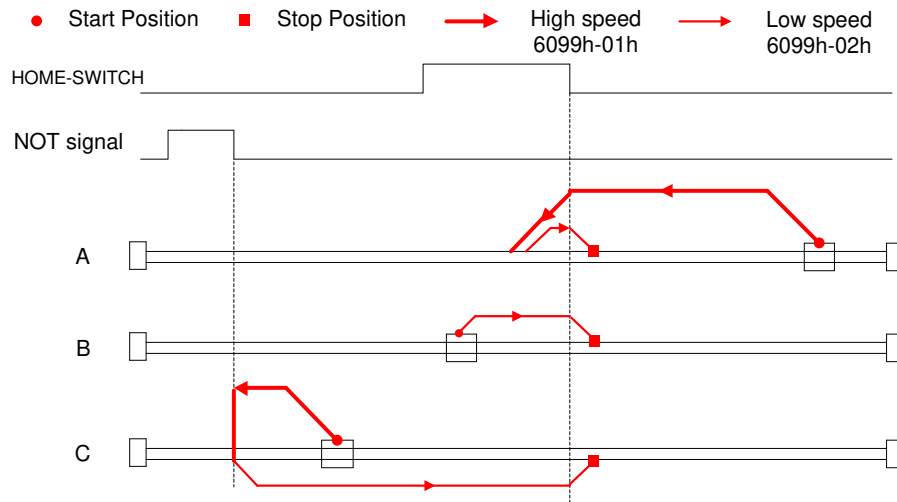
Method 28:

This method is similar to method 12

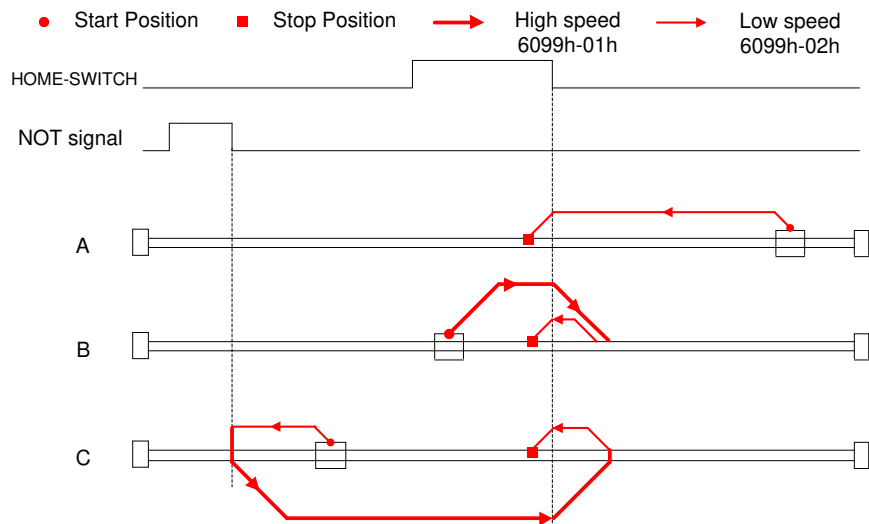

Method 29:

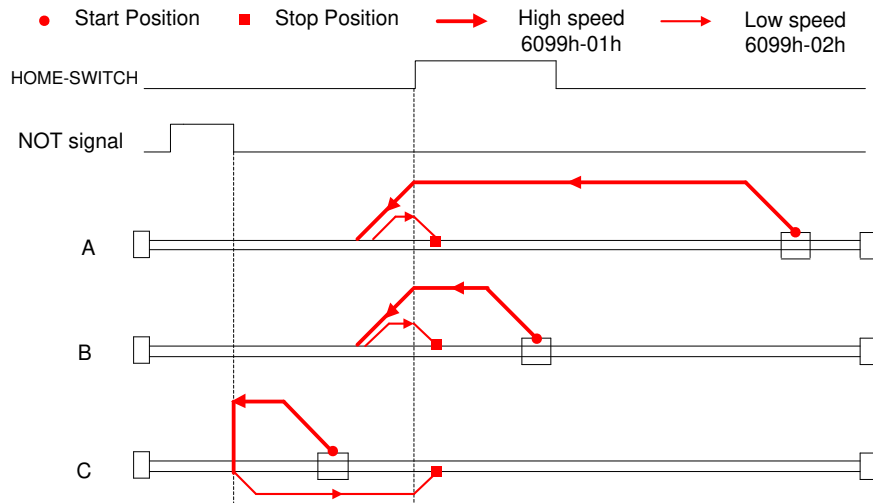
This method is similar to method 13

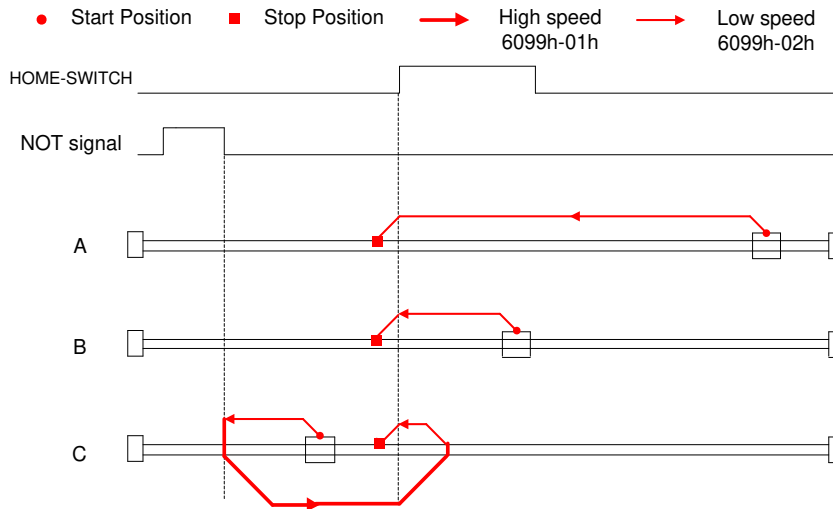

Method 30:

This method is similar to method 14

Method 33:

The motor starts to move in a negative direction and stops when the Z signal is valid.

If the positive/negative limit switch signal and homing switch is valid during the homing process, the status word (6041h) bit 13 will be valid, indicating that the homing error and the motor will stop immediately.

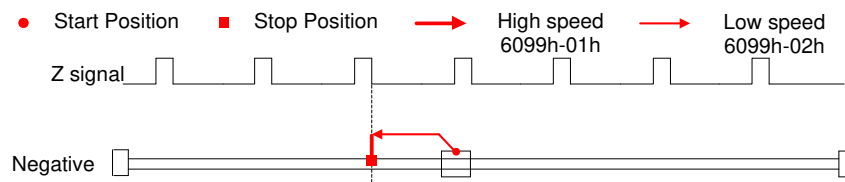
Method 34:

The motor starts to move in a positive direction and stops when the Z signal is valid.

If the positive/negative limit switch signal and homing switch is valid during the homing process, the status word (6041h) bit 13 will be valid, indicating that the homing error and the motor will stop immediately.

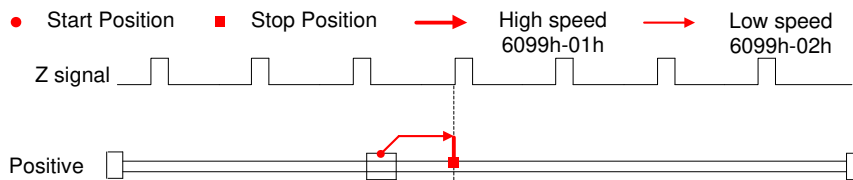
Method 35/37:

Set the current position as homing point.

When using this method, the motor does not need to be enabled, only the control word (6041h) needs to be executed from 0 to 1.

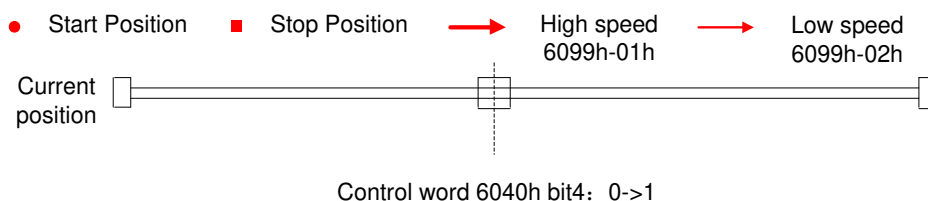

7.5.4.5 Example of Homing Mode

Steps:

- 1: Setup Operation mode 6060h =6, check whether 6061h =6, make sure the drive has changed to Homing mode.
- 2: Setup homing method 6098h, homing speed 6099h-01/6099h-02 and homing acceleration 609Ah
- 3: In enable status, setup bit4=1 (6040h) to trigger homing mode.

7.6 Velocity Mode (CSV, PV)

7.6.1 Common Functions of Velocity Mode

Index	Sub Index	Name	Units	Range	Data Type	Access	PDO	Mode		
								pp	CSP	HM
6040	0	Control word		0 - 65535	U16	rw	RxPDO			
6072	0	Max torque	0.1 %	0 - 65535	U16	rw	RxPDO			
6080	0	Maximum motor speed	r/min		U32	rw	RxPDO			
60B1	0	Velocity feedforward(Restricted by 6080)	Command unit /s		U32	rw	RxPDO			
60B2	0	Torque feedforward	0.001		U32	rw	RxPDO			
60FF	0	Target speed (Restricted by 6080)	Command unit /s		U32	rw	RxPDO			

Index	Sub Index	Name	Units	Range	Data Type	Access	PDO	Mode		
								pp	CSP	HM
6041	0	Status word	-							
6063	0	Actual internal position value								
6064	0	Actual feedback position value								
606B	0	Internal command speed	Command unit							
606C	0	Actual feedback speed value								
6074	0	Internal torque	0.001							

		command							
6076	0	Rated torque	mN.M						
6077	0	Actual torque	0.1%						

7.6.2 Cyclic Synchronous Velocity Mode (CSV)

7.6.2.1 Block Diagram

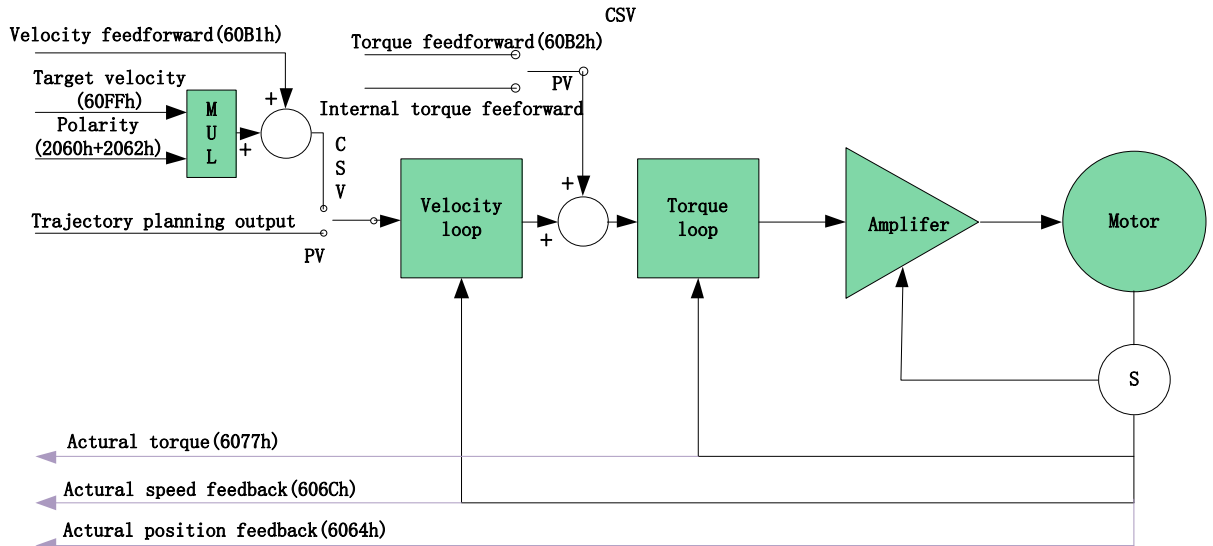

7.6.2.2 Related Objects

Basic object

PDO	Index+Sub-Index	Name	Data Type	Access	Unit	Notes
(RXPDO)	6040-00h	Control word	U16	RW	—	Required
	60FF-00h	Target velocity	I32	RW	Uint	Required
	60B1-00h	Velocity feedforward	I32	RW	Uint /S	Optional
	60B2-00h	Torque feedforward	I16	RW	0.1%	Optional
(TXPDO)	6041-00h	Status word	U16	RO	—	Required
	6064-00h	Actual position feedback value	I32	RO	Uint	Optional
	606C-00h	Actual speed feedback value	I32	RO	Uint /S	Optional
	60F4-00h	Actual following error	I32	RO	Uint	Optional
	6077-00h	Actual torque	I16	RO	0.1%	Optional

Extended object

Index+Sub-Index	Name	Data Type	Access	Unit
603F-00h	Error code	U16	RO	—
6060-00h	Operation mode	I8	RW	—

6061-00h	Displayed operation mode	I8	RO	—
606B-00h	Internal command speed	I32	RO	Uint
605A-00h	Quick stop option code	I16	RW	—
6085-00h	Quick stop deceleration	U32	RW	Uint /S

Pr3.12	Name	time setup acceleration			Mode		PV				CSV
	Range	0~10000	Unit	Ms/ (1000RPM)	Default	100	Index			2312h	
Pr3.13	Name	time setup deceleration			Mode		PV				CSV
	Range	0~10000	Unit	Ms/ (1000RPM)	Default	100	Index			2313h	

Set up acceleration/deceleration processing time in response to the speed command input. Set the time required for the speed command(stepwise input)to reach 1000r/min to Pr3.12 Acceleration time setup. Also set the time required for the speed command to reach from 1000r/min to 0 r/min, to Pr3.13 Deceleration time setup.

Assuming that the target value of the speed command is V_c (r/min), the time required for acceleration/deceleration can be computed from the formula shown below.

$$\text{Acceleration time (ms)} = V_c / 1000 * \text{Pr3.12} * 1 \text{ms}$$

$$\text{Deceleration time (ms)} = V_c / 1000 * \text{Pr3.13} * 1 \text{ms}$$

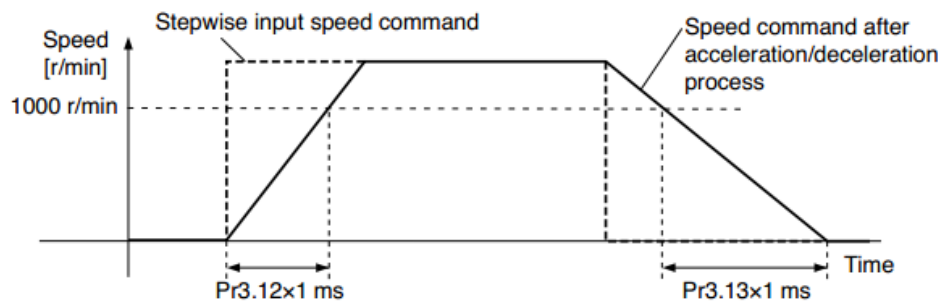

Pr3.14	Name	Sigmoid acceleration/deceleration time setup			Mode		PV				CSV
	Range	0~1000	Unit	ms	Default	0	Index			2314h	

Set S-curve time for acceleration/deceleration process when the speed command is applied. According to Pr3.12 Acceleration time setup and Pr3.13 Deceleration time setup, set up sigmoid time with time width centering the inflection point of acceleration/deceleration.

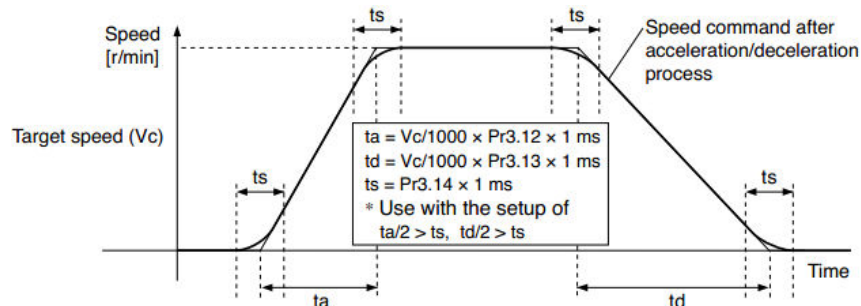

This function can be configured through IO output function parameters, refer to IO Pr4.10 parameter description. When the speed meets the set condition, the corresponding output IO port can output ON.

Pr4.36	Name	At-speed(Speed arrival)			Mode		PV				CSV
	Range	10~2000	Unit	RPM	Default	1000	Index			2436h	

Set the detection timing of the speed arrival output (AT-SPEED).
 When the motor speed exceeds this setup value, the speed arrive output (AT-SPEED) is output.
 Detection is associated with 10r/min hysteresis .

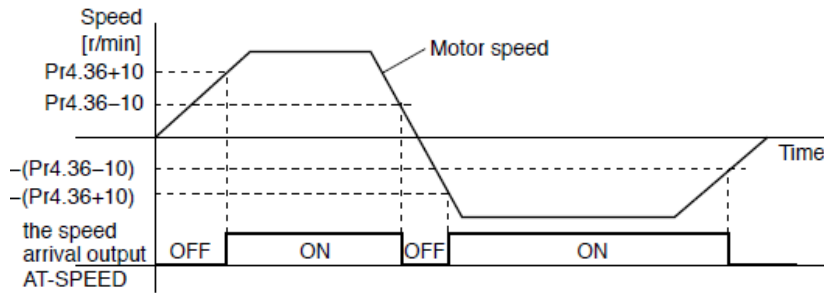

Pr4.35	Name	Speed coincidence range		Mode		PV			CSV
	Range	10~2000	Unit	RPM	Default	50	Index		2435h

Set the speed coincidence (V-COIN) output detection timing.
 Output the speed coincidence (V-COIN) when the difference between the speed command and the motor speed is equal to or smaller than the speed specified by this parameter.

Because the speed coincidence detection is associated with 10 r/min hysteresis, actual detection range is as shown below.

Speed coincidence output OFF -> ON timing (Pr4.35 -10) r/min
 Speed coincidence output ON -> OFF timing (Pr4.35 +10) r/min

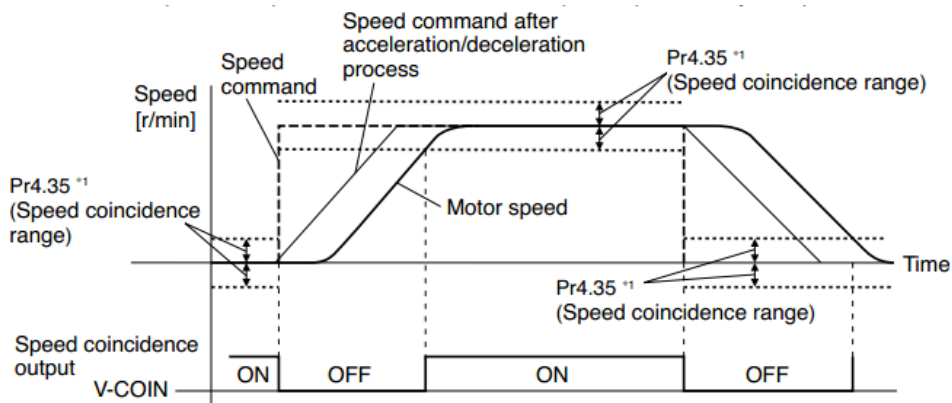

Pr3.16	Name	Speed zero-clamp level		Mode		PV			CS V
	Range	10~2000	Unit	RPM	Default	30	Index		2316h

When speed given value under speed control mode less than zero speed clamp level setup, speed command will set to 0 strongly.

7.6.3 Profile Velocity Mode (PV)

In asynchronous motion mode, the master station is only responsible for sending motion parameters and control commands. EL7-EC servo driver will conduct trajectory planning according to the motion parameters sent by the master station after receiving the motion start command from the master station. In asynchronous motion mode, the motion between each motor shaft is asynchronous.

7.6.3.1 Block Diagram

The difference between PV and CSV mode is that PV needs EL7-EC to have the function of track generator, so PV needs to add track generator in the entry part of track generation in figure 7.5. The input and output structure of the track generator is shown in figure 7.8

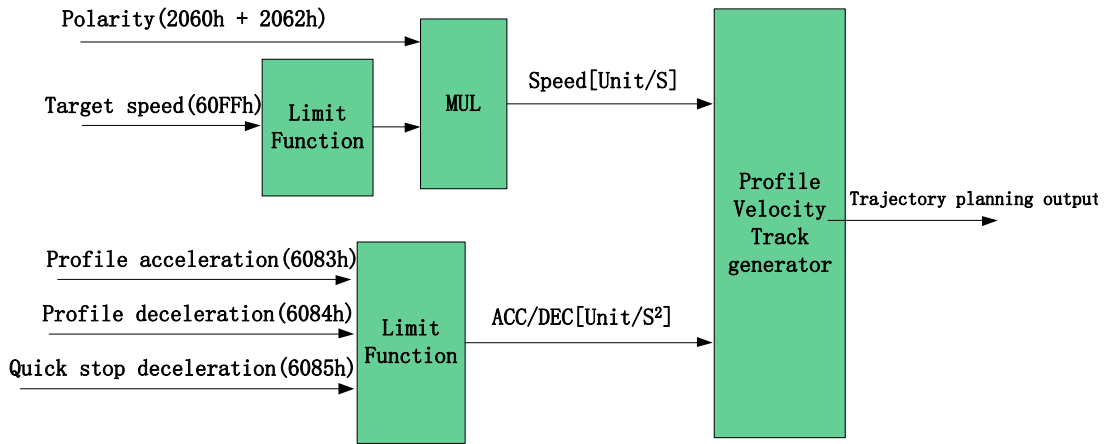

7.6.3.2 Related Objects

Basic object

PDO	Index+Sub-Index	Name	Data Type	Access	Unit	Notes
(RXPDO)	6040-00h	Control word	U16	RW	—	Required
	60FF-00h	Target speed	I32	RW	Uint	Required
	6083-00h	Acceleration	I32	RW	Uint /S	Optional
(TXPDO)	6041-00h	Status word	U16	RO	—	Required
	6064-00h	Position feedback	I32	RO	Uint	Optional
	606C-00h	Speed feedback	I32	RO	Uint /S	Optional
	60F4-00h	Actual following error	I32	RO	Uint	Optional
	6077-00h	Actual torque	I16	RO	0.1%	Optional

Extended object

Index+Sub-Index	Name	Data Type	Access	Unit
603F-00h	Error code	U16	RO	—
6060-00h	Operation mode	I8	RW	—
6061-00h	Displayed operation mode	I8	RO	—
605A-00h	Quick stop option code	I16	RW	—
6084-00h	Deceleration	U32	RW	Uint /S
6085-00h	Quick stop deceleration	U32	RW	Uint /S

7.6.3.3 Control Word and Status Word for Profile velocity Mode

The bit6~4 of control words (6040h) associated with the control mode in PV mode are invalid. The motion in PV mode can be triggered as long as the motion parameters (target velocity (60FFh)

ACC/DEC (6083h/6084h) are given after the axis is enabled.

Table7. Bit15~12、 10、 8 of Status word (6041h) for Profile Velocity Mode

Bit (Name)	Value	Details
8 (Quick stop)	0	Quick stop invalid
	1	Quick stop valid
10 (Speed arrival)	0	Speed not arrival yet
	1	Speed arrival
12 (Zero speed)	0	It's not zero speed. It's moving.
	1	Zero speed or it's going to slow down to zero speed *1)

*1) Zero speed of bit 12 is generally effective when deceleration stop and hardware limit valid.

7.6.3.4 Example of Profile Velocity Mode

Steps:

- 1: Setup Operation mode 6060h =3, check whether 6061h =3, make sure the drive has changed to PV mode.
- 2: Setup target speed 60FFh, acceleration 6083h and deceleration 6084h.

7.7 Torque Mode (CST, PT)

7.7.1 Common Functions of torque Mode

Index	Sub Index	Name	Units	Range	Data Type	Access	PDO	Mode		
								pp	CSP	HM
6040	0	Control word		0 - 65535	U16	rw	RxPDO			
6071	0	Target torque	0.001							
6072	0	Max torque	0.1%	0 - 65535	U16	rw	RxPDO			
6080	0	Maximum motor speed	r/min		U32	rw	RxPDO			
6087	0	Torque change rate	0.001/s							
60B2	0	Torque feedforward	0.001							

Index	Sub Index	Name	Units	Range	Data Type	Access	PDO	Mode		
								pp	CSP	HM
6041	0	Status word	-							
6063	0	Actual internal position value								
6064	0	Actual feedback position value								
606C	0	Actual feedback								

		speed value								
6074	0	Internal torque command	0.001							
6075	0	Rated current	mA							
6076	0	Rated torque	mN.M							
6077	0	Actual torque	0.1%							
6079	0	Bus voltage	mV							

7.7.2 Cyclic Synchronous Torque Mode (CST)

7.7.2.1 Block Diagram

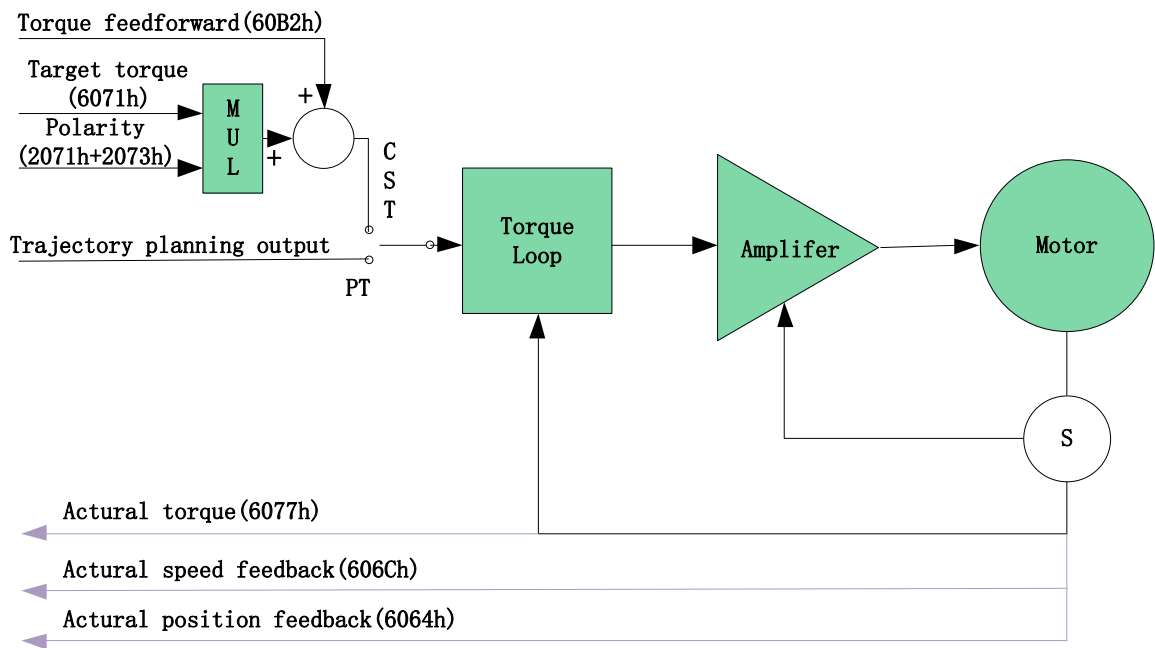

7.7.2.2 Related Objects

Basic object

PDO	Index+Sub-Index	Name	Data Type	Access	Unit	Notes
(RXPDO)	6040-00h	Control word	U16	RW	—	Required
	6071-00h	Target torque	I16	RW	Uint	Required
	6087-00h	Torque feedforward	U32	RW	0.1%/S	Optional
(TXPDO)	6041-00h	Status word	U16	RO	—	Required
	6064-00h	Actual position feedback value	I32	RO	Uint	Optional
	606C-00h	Actual speed feedback value	I32	RO	Uint /S	Optional
	60F4-00h	Actual following error	I32	RO	Uint	Optional
	6077-00h	Actual torque	I16	RO	0.1%	Required

Extended object

Index+Sub-Index	Name	Data Type	Access	Unit
603F-00h	Error code	U16	RO	—
6060-00h	Operation mode	I8	RW	—
6061-00h	Displayed operation mode	I8	RO	—
6074-00h	Internal command torque	I16	RO	0.1%
605A-00h	Quick stop option code	I16	RW	—
6080-00h	Maximum motor speed	U32	RW	Unit /S
6085-00h	Quick stop deceleration	U32	RW	Unit /S
60B1-00h	Velocity feedforward	I32	RW	Unit /S
2077-00h	Speed limit	I16	RW	RPM

7.7.3 Profile Torque Mode (PT)

In asynchronous motion mode, the master station is only responsible for sending motion parameters and control commands. EL7-EC servo driver will conduct trajectory planning according to the motion parameters sent by the master station after receiving the motion start command from the master station. In asynchronous motion mode, the motion between each motor shaft is asynchronous.

7.7.3.1 Block Diagram

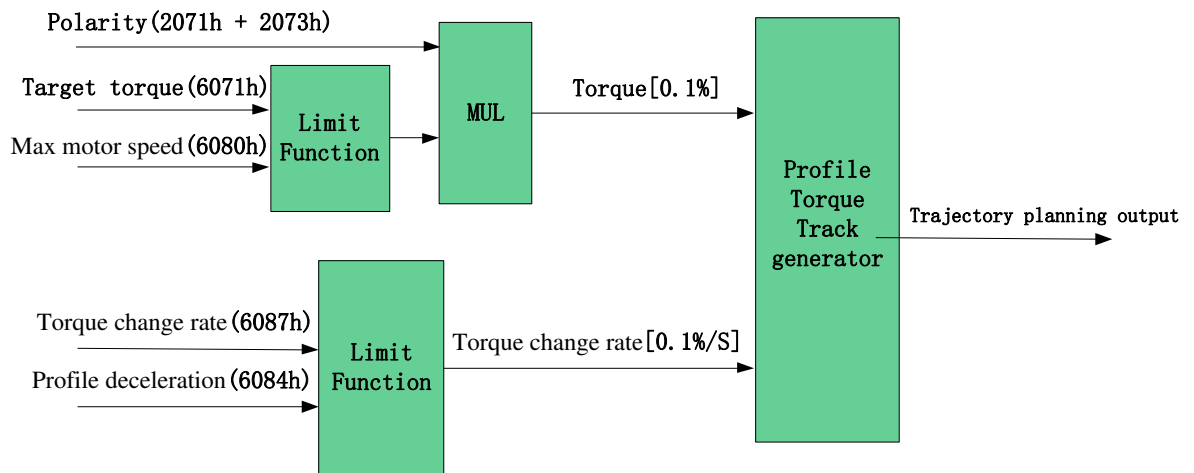

7.7.3.2 Related Objects

Basic object

PDO	Index+Sub-Index	Name	Data Type	Access	Unit	Notes
(RXPDO)	6040-00h	Control word	U16	RW	—	Required
	6071-00h	Target torque	I16	RW	0.1%	Required

	6087-00h	Torque change rate	U32	RW	0.1%/S	Optional
(TXPDO)	6041-00h	Status word	U16	RO	—	Required
	6064-00h	Actual feedback position value	I32	RO	Uint	Optional
	606C-00h	Actual feedback speed value	I32	RO	Uint /S	Optional
	60F4-00h	Actual following error	I32	RO	Uint	Optional
	6077-00h	Actual torque	I16	RO	0.1%	Optional

Extended object

Index+Sub-Index	Name	Data Type	Access	Unit
603F-00h	Error code	U16	RO	—
6060-00h	Operation mode	I8	RW	—
6061-00h	Displayed operation mode	I8	RO	—
6074-00h	Internal command torque	I16	RO	0.1%
6080-00h	Maximum motor speed	U32	RW	Uint /S
605A-00h	Quick stop option code	I16	RW	—
6085-00h	Quick stop deceleration	U32	RW	Uint /S
2077-00h	Speed limit	I16	RW	RPM

7.7.3.3 Example of Profile Torque Mode

Steps:

- 1: Setup Operation mode 6060h =4, check whether 6061h =4, make sure the drive has changed to PT mode.
- 2: Setup target torque 6071h, torque change rate 6087h, maximum motor speed 6080h

Chapter 8 Application Case

8.1 Multi-turn absolute encoder

The absolute encoder remember position, When the absolute encoder is used for the first time, it needs to move to the home position, and clear the absolute position value of multiple turns through the driver to set the home position. It is unnecessary to return to zero in the future (except for the absolute encoder alarm and other situations). It is recommended that the motor is stationary when reading the position to prevent dynamic data jump.

8.1.1 Parameters setting

Pr0.15	Name	Absolute Encoder Setup			Mode	PP		H	M	CSP		
	Range	0~15	Unit	-	Default	0	Index				2015h	
How to use: 0: incremental mode, close multi-turn absolute function, multi-turn position invalid; 1: Multi-turn linear mode, open multi-turn absolute function; 2: Multi-turn rotation mode, open multi-turn absolute function, Multi-turn data between 0 - (Pr6.63+1) cycle 5: clean multi-turn alarm, and open multi-turn absolute function. It will become 1 when normal clearance, if it's still 5 after 3seconds, please deal with according to 153 alarm processing. 9: multi-turn zero clearing and reset multi-turn alarm, open multi-turn absolute function. It will become 1 when normal clearance, if it's still 9 after 3seconds, please deal with according to 153 alarm processing. Please remember to do mechanical homing. Note: valid after restart power-supply												

8.1.2 Read absolute position

1、Steps:

- 1). Firstly, select the multi-turns absolute encoder motor, install the battery, and confirm whether the driver version supports multi-turns absolute encoder motor;
- 2). Set Pr0.15=1 to open absolute encoder. If it is the first time of installation, the driver will alarm Err153. The reason is that the multi-turn position is invalid due to the newly installed battery of the motor. At this time, it is necessary to return to the home position of the machine and perform the multi-turn position reset operation (see multi-turn position reset).
- 3). When the absolute value origin is set and there is no battery fault, the alarm will be cancelled
- 4). Finally, the user can read the absolute position, even if the power off the position will not lost.

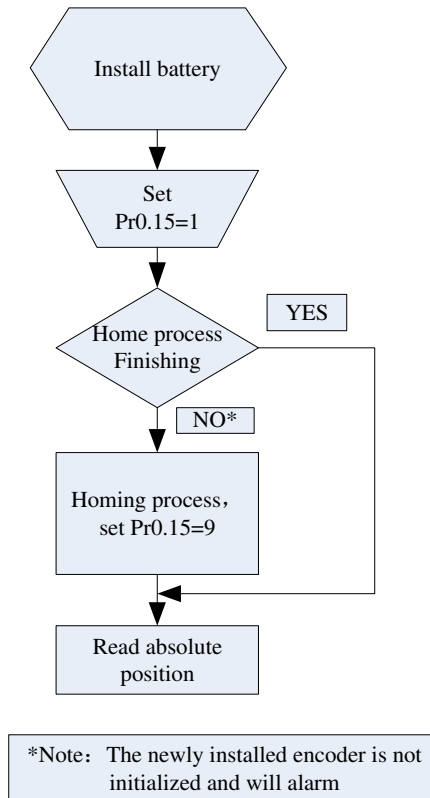

2、 Read absolute position

The absolute encoder counting mode is that when the motor rotates clockwise, the number of turns is defined as negative, while motor rotates counterclockwise the number of turns is defined as positive. The maximum rotation number is -32768 to +32767. After the number of turns is out of range, if the number of turns is 32767 counterclockwise, it will reverse to -32768, -32767... ; If the number of turns clockwise -32768, it will reverse to 32767, 32766...

Absolute encoder read mode: read 6064h data object.

3、 Clear absolute position

Before clear absolute position, the machine needs to return to the home point. After clear absolute position, the absolute position =0, the single-turn position remains unchanged, and the absolute value of the encoder alarm is cleared.

Set Pr0.15=9: multi-turn zero clearing and reset multi-turn alarm, open multi-turn absolute function. It will become 1 when normal clearance, if it's still 9 after 3seconds, please deal with according to 153 alarm processing. Please remember to do mechanical homing.

8.1.3 Alarm

1、 Introductions

The multi-turns absolute encoder alarm function can determine whether the absolute encoder is valid or not, such as battery under voltage or power failure, encoder fault, etc., users can judge the absolute encoder alarm through bus alarm output, IO alarm output, and driver operation panel alarm. At this time, the controller should stop operation immediately, and the absolute motion

operation can only be carried out after the alarm is eliminated

2、 Alarm output

Absolute encoder alarm can be displayed by the panel Err153, IO output alarm signal, or read alarm information by communication

3、 The driver sends an absolute encoder alarm Err153, the main situation is as follows:

(1) When the absolute encoder is used for the first time, absolute encoder alarm will be generated due to the new battery of the motor. At this time, it is necessary to return to the home point and perform multi-turn zero clearing operation

(2) When the battery under voltage is lower than 3.2v, absolute encoder alarm will be generated by the driver. At this time, the alarm will be automatically eliminated after the battery is recharged by replacing the battery

(3) When the battery voltage is lower than 2.5v, or the battery has a power failure, the absolute encoder alarm will be generated. Even if the battery is replaced, the alarm cannot be eliminated. At this time, the return to the home point and multi-turn zero clearing operation should be performed

4、 Alarm processing flow chart

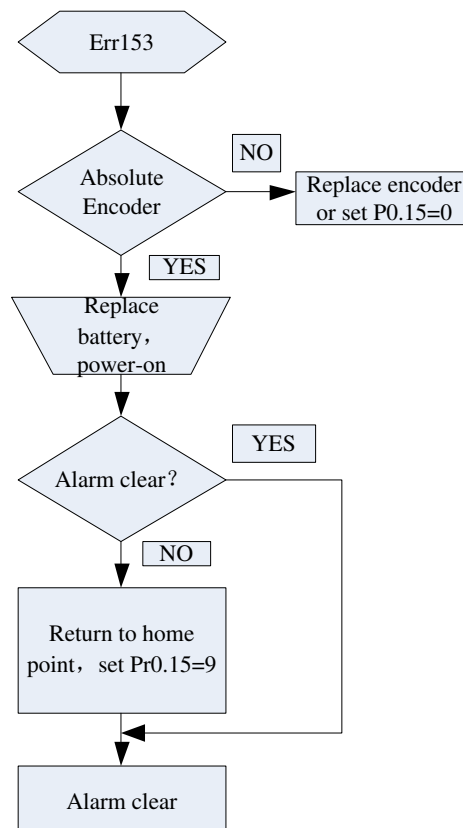

8.2 Touch Probe Function (Latch Function)

The latch function latches the position actual value (reference unit) when an external latch input signal or the encoder's phase-Z signal changes.

The EL7-EC provides two touch probes for recording the position of each touch probe signal at the rising edge and falling edge, four positions can be latched. EXT1 signal of CN1 port or motor Z signal can be allocated to touch probe 1, EXT2 signal of CN1 port or motor Z signal can be allocated to touch probe 2.

Pr0.07	Name	Touch probe polarity setting			Mode						F										
	Range	0 ~ 3	Unit	—	Default	3	Index		2007h												
<table border="1"> <thead> <tr> <th>Setup value</th> <th>Details</th> </tr> </thead> <tbody> <tr> <td>0</td> <td>Touch probe 1 and touch probe 2 have reversed polarity</td> </tr> <tr> <td>1</td> <td>Touch probe 2 reversed polarity only</td> </tr> <tr> <td>2</td> <td>Touch probe 1 reversed polarity only</td> </tr> <tr> <td>3</td> <td>Touch probe 1 and touch probe 2 do not have reversed polarity</td> </tr> </tbody> </table> <p>Note: valid after restart the power.</p>												Setup value	Details	0	Touch probe 1 and touch probe 2 have reversed polarity	1	Touch probe 2 reversed polarity only	2	Touch probe 1 reversed polarity only	3	Touch probe 1 and touch probe 2 do not have reversed polarity
Setup value	Details																				
0	Touch probe 1 and touch probe 2 have reversed polarity																				
1	Touch probe 2 reversed polarity only																				
2	Touch probe 1 reversed polarity only																				
3	Touch probe 1 and touch probe 2 do not have reversed polarity																				

Pr5.33	Name	Touch probe 1 signal compensation time			Mode						F
	Range	0~32767	Unit	25ns	Default	0	Index		2533h		
Time compensation for signal acquisition of touch probe 1 to provide more accurate capture position and prevent the instantaneous jitter of capture during master and slave cooperation											

Pr5.34	Name	Touch probe 2 signal compensation time			Mode						F
	Range	0~32767	Unit	25ns	Default	0	Index		2534h		
Time compensation for signal acquisition of touch probe 2 to provide more accurate capture position and prevent the instantaneous jitter of capture during master and slave cooperation											

8.2.1 Block Diagram

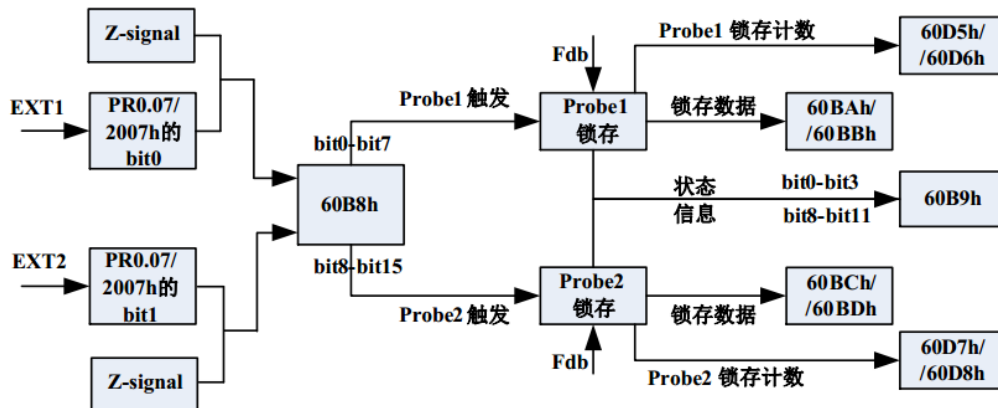

When using EXT1 or EXT2 as a touch probe , setting as following :

- Set the polarity of touch probe 1 and touch probe 2, the relevant parameter is 0x2007/Pr0.07
- Set the touch probe function in 0x60B8, bit 0~7 for touch probe 1, bit 8~15 for touch probe 2. The function including enable or not、triggerring mode、triggerring signal.

Notes:

- When the triggering mode is triggered only when the trigger signal is valid first time not the continue mode, the rising edge and falling edge are set for the same touch probe, only the rising

edge is valid. But when the triggering mode is continue mode, the rising edge and falling edge are set for the same touch probe, both the rising edge and falling edge are valid

(ii) While the touch probe function 0x60B8 is changed, the count registers will start counting again. The touch probe status 0x60B9 will also change.

(iii) The level of the touch probe signal is displayed in 60FD, EXT1 corresponds to bit26 in 60FD, and EXT2 corresponds to bit27 in 60FD. Whether the level is displayed or not is no longer related to whether the 60B8 enable touch probe or not.

(iiii) When used with the master controller, if the motor has a slight vibration after the probe is captured, users can compensate the touch probe by setting Pr5.33 and Pr5.34.

8.2.2 Related Objects

Index	Sub Index	Name	Access	Data Type	Units	Range	Default
2007h	00h	Touch probe 1 polarity setting	RW	Uint16		0~0xFFFF	1
2007h	01h	Touch probe 2 polarity setting	RW	Uint16		0~0xFFFF	1
60B8h	00h	Touch probe control word	RW	Uint16		0~65535	0
60B9h	00h	Touch probe statue word	RO	Uint16		0~65535	0
60BAh	00h	Touch probe 1 rising edge capture position	RO	int32	Command unit	-2147483648~2147483647	0
60BBh	00h	Touch probe 1 falling edge capture position	RO	int32	Command unit	-2147483648~2147483647	0
60BCh	00h	Touch probe 2 rising edge capture position	RO	int32	Command unit	-2147483648~2147483647	0
60BDh	00h	Touch probe 2 falling edge capture position	RO	int32	Command unit	-2147483648~2147483647	0
60D5h	00h	Touch probe 1 rising edge counter	RO	Uint32		0~4294967296	0
60D6h	00h	Touch probe 1 falling edge counter	RO	Uint32		0~4294967296	0
60D7h	00h	Touch probe 2 rising edge counter	RO	Uint32		0~4294967296	0
60D8h	00h	Touch probe 2 falling edge counter	RO	Uint32		0~4294967296	0

8.2.3 Signal Input of EXT1 and EXT2

EXT1: Pin3 and Pin4 of CN1 port.

EXT2: Pin5 and Pin6 of CN1 port

8.2.4 Touch Probe Control Word 60B8h

Bit	Definition	Details
0	Touch Probe 1 enable	0--Disable 1--Enable

1	Touch Probe 1 mode	0--Single trigger mode, triggered only when the trigger signal is valid first time 1--Continue trigger mode
2	Touch Probe 1 trigger signal selection	0--EXT1 signal input 1--Z signal
3		
4	Touch Probe 1 rising edge trigger	0--Disable 1--Enable
5	Touch Probe 1 falling edge trigger	0--Disable 1--Enable
6-7		
8	Touch Probe 2 enable	0--Disable 1--Enable
9	Touch Probe 2 mode	0--Single trigger mode, triggered only when the trigger signal is valid first time 1--Continue trigger mode
10	Touch Probe 2 trigger signal selection	0--EXT2 signal input 1--Z signal
11		
12	Touch Probe 2 rising edge trigger	0--Disable 1--Enable
13	Touch Probe 2 falling edge trigger	0--Disable 1--Enable
14-15		

8.2.5 Touch Probe Statue Word 60B9h

Bit	Definition	Details
0	Touch Probe 1 enable	0--Disable 1--Enable
1	Touch Probe 1 rising edge trigger	0-- not executed 1-- executed
2	Touch Probe 1 falling edge trigger	0-- not executed 1-- executed
3-5		
6-7		
8	Touch Probe 2 enable	0--Disable 1--Enable
9	Touch Probe 2 rising edge trigger	0-- not executed 1-- executed
10	Touch Probe 2 falling edge trigger	0-- not executed 1-- executed
11-13		
14-15		

8.2.6 Latch Position Register

Index	Details
60BAh	Touch probe 1 rising edge capture position
60BBh	Touch probe 1 falling edge capture position
60BCh	Touch probe 2 rising edge capture position
60BDh	Touch probe 2 falling edge capture position

8.2.7 Latch Counter Register

Index	Details
60D5h	Touch probe 1 rising edge counter
60D6h	Touch probe 1 falling edge counter
60D7h	Touch probe 2 rising edge counter
60D8h	Touch probe 2 falling edge counter

8.2.8 Touch Probe mode

Set bit1/bit9 of 60B8h (Touch Probe mode), 0 for Single trigger mode, 1 for Continue trigger mode.

(1) Single trigger mode

Triggered only when the trigger signal is valid first time. In order to latch the position, users need to set bit0/bit8 of 60B8h to 0, then set bit0/bit8 of 60B8h to 1. The sequence diagram is as follows:

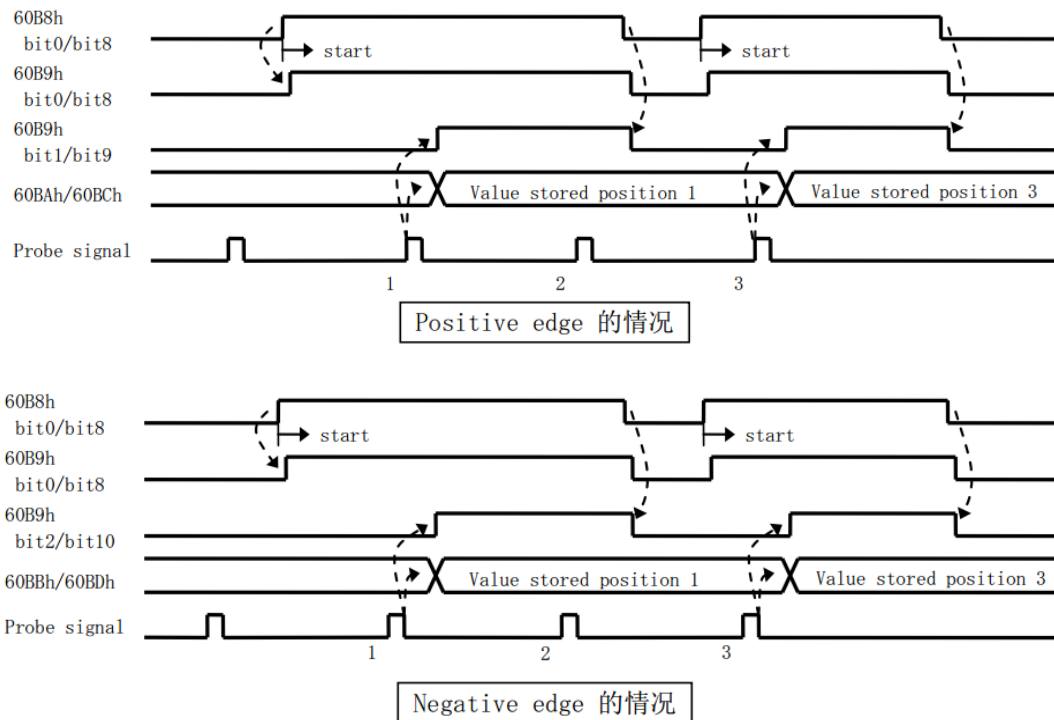

(2) Continue trigger mode

The sequence diagram is as follows:

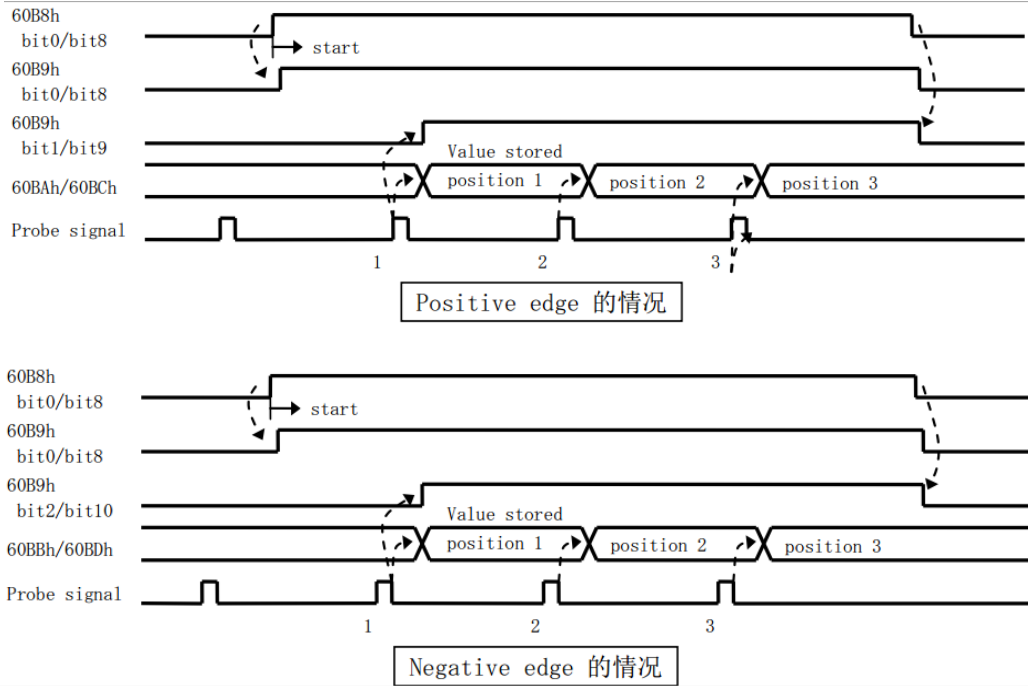

8.3 Security Features

8.3.1 Torque Limit (TL-SEL)

Pr5.21	Name	Selection of torque limit			Mode						F												
	Range	0~2	Unit	—	Default	0	Index	2521h															
Set up the torque limiting method;																							
<table border="1"> <thead> <tr> <th>Setup value</th> <th>Positive limit value</th> <th>Negative limit value</th> </tr> </thead> <tbody> <tr> <td>0</td> <td>Pr0.13</td> <td>Pr0.13</td> </tr> <tr> <td>1</td> <td>Pr0.13</td> <td>Pr5.22</td> </tr> <tr> <td>2</td> <td>60E0</td> <td>60E1</td> </tr> </tbody> </table>												Setup value	Positive limit value	Negative limit value	0	Pr0.13	Pr0.13	1	Pr0.13	Pr5.22	2	60E0	60E1
Setup value	Positive limit value	Negative limit value																					
0	Pr0.13	Pr0.13																					
1	Pr0.13	Pr5.22																					
2	60E0	60E1																					
Compared with the maximum torque 6072, the actual torque limit value is smaller one																							

Pr0.13	Name	1st Torque Limit			Mode						F
	Range	0~500	Unit	%	Default	300	Index	2013h			
You can set up the limit value of the motor output torque, as motor rate current %, the value can't exceed the maximum of output current. Compared with the maximum torque 6072, the actual torque limit value is smaller one.											

Pr5.22	Name	2nd torque limit			Mode						F
	Range	0~500	Unit	%	Default	300	Index	2522h			
Set up the 2 nd limit value of the motor torque output The value of the parameter is limited to the maximum torque of the applicable motor. Compared with the maximum torque 6072, the actual torque limit value is smaller one											

8.3.2 Emergency Stop Time at Alarm

Pr6.14	Name	Emergency stop time at alarm			Mode															F
	Range	0~3000	Unit	ms	Default	200	Index			2614h										
Set up the time allowed to complete emergency stop in an alarm condition, exceeding this time puts this system in alarm state.																				

8.3.5 Emergency Stop

1: This function can be configured through IO input function parameters, refer to IO parameter Pr4.00 description.

Pr4.43	Name	E-stop function			Mode																F
	Range	0~1	Unit	-	Default	0	Index			2443h											
0: When E-STOP is effective, the servo will forced to STOP and servo-disabled, and alarm showing (Err570) . 1: When E-STOP is effective, the servo will forced to STOP and keep in servo-enable, no alarm showing.																					

2: Send the corresponding object dictionary through the master station to trigger the quick stop function.

Pr5.11	Name	Torque setup for emergency stop			Mode																F
	Range	0~500	Unit	%	Default	0	Index			2511h											
Set up the torque limit at emergency stop When setup value is 0, the torque limit for normal operation is applied. Compared with the maximum torque 6072, the actual torque limit value is smaller one.																					

8.4 Gain Adjustment

Pr0.02=0, these gain parameters can be modified one by one.

Pr0.02=1/2, after setting stiffness Pr0.03, Pr1.00~Pr1.09 will be updated the value automatically that corresponding to the stiffness value, and Pr1.10~Pr1.19 is always a constant value

The difference between Pr0.02=1 standard mode and Pr0.02=2 positioning mode is whether the first gain is switched to the second gain due to Pr1.15. No switching second gain in standard mode; The first gain and the second gain are switched according to Pr1.15

Pr0.02	Name	Real-time Auto-gain Tuning			Mode																F											
	Range	0~2	Unit	—	Default	0	Index			2002h																						
You can set up the action mode of the real-time auto-gain tuning.																																
<table border="1"> <thead> <tr> <th>Setup value</th> <th>mode</th> <th>Varying degree of load inertia in motion</th> </tr> </thead> <tbody> <tr> <td>0</td> <td>invalid</td> <td>Real-time auto-gain tuning function is disabled.</td> </tr> <tr> <td>1</td> <td>standard</td> <td>Basic mode. do not use unbalanced load, friction compensation or gain switching. It is usually for interpolation movement.</td> </tr> <tr> <td>2</td> <td>positioning</td> <td>Main application is positioning, it is recommended to use this mode on equipment without unbalanced horizontal axis, ball screw driving equipment with low friction, etc. it is usually for point-to point movement .</td> </tr> </tbody> </table>																					Setup value	mode	Varying degree of load inertia in motion	0	invalid	Real-time auto-gain tuning function is disabled.	1	standard	Basic mode. do not use unbalanced load, friction compensation or gain switching. It is usually for interpolation movement.	2	positioning	Main application is positioning, it is recommended to use this mode on equipment without unbalanced horizontal axis, ball screw driving equipment with low friction, etc. it is usually for point-to point movement .
Setup value	mode	Varying degree of load inertia in motion																														
0	invalid	Real-time auto-gain tuning function is disabled.																														
1	standard	Basic mode. do not use unbalanced load, friction compensation or gain switching. It is usually for interpolation movement.																														
2	positioning	Main application is positioning, it is recommended to use this mode on equipment without unbalanced horizontal axis, ball screw driving equipment with low friction, etc. it is usually for point-to point movement .																														
Caution: If pr0.02=1 or 2 , you can't modify the values of Pr1.01 – Pr1.13, the values of them depend on the real-time auto-gain tuning ,all of them are set by the driver itself.																																

Pr0.03	Name	Selection of machine stiffness at real-time auto-gain tuning			Mode						F
	Range	50 ~ 81	Unit	—	Default	70	Index			2003h	

You can set up response while the real-time auto-gain tuning is valid.

Low → Machine stiffness → High

Low → Servo gain → High

81.80.....70.69.68.....51.50

Low → Response → High

Notice: Lower the setup value, higher the velocity response and servo stiffness will be obtained. However, when decreasing the value, check the resulting operation to avoid oscillation or vibration. Control gain is updated while the motor is stopped. If the motor can't be stopped due to excessively low gain or continuous application of one-way direction command, any change made to Pr0.03 is not used for update. If the changed stiffness setting is made valid after the motor stopped, abnormal sound or oscillation will be generated. To prevent this problem, stop the motor after changing the stiffness setting and check that the changed setting is enabled.

8.5 Inertia Ratio Identification

Pr0.04	Name	Inertia ratio			Mode						F
	Range	0~10000	Unit	%	Default	250	Index			2004h	

You can set up the ratio of the load inertia against the rotor(of the motor)inertia.

Pr0.04=(load inertia/rotate inertia)×100%

Notice:

If the inertia ratio is correctly set, the setup unit of Pr1.01 and Pr1.06 becomes (Hz). When the inertia ratio of Pr0.04 is larger than the actual value, the setup unit of the velocity loop gain becomes larger, and when the inertia ratio of Pr0.04 is smaller than the actual value, the setup unit of the velocity loop gain becomes smaller.

8.5.1 On-line Inertia Ratio Identification

The motor is operated by the controller, and the motor speed is above 400rpm. The running stroke has obvious acceleration, uniform speed and deceleration process, and the load inertia ratio can be tested by running 2-3 times continuously. The inertia ratio of the test is viewed through panel d16. Write the corresponding panel value minus 100 into PA004.

8.5.2 Off-line Inertia Ratio Identification

Pre-conditions: 1、 servo disable. 2、 Positive limit and negative limit invalid

Steps:

- 1、 Set the trial running speed PA604, and the setting of PA604 should not be too large
- 2、 Enter auxiliary inertia ratio identification function on the drive panel, AF_GL
- 3、 Press ENT once to enter operation, display “G---”
- 4、 Press ◀ once, display “StUon”
- 5、 Press ▲ once, motor start running to identification

- 6、 After finishing, display G XXX, which represents the measured inertia ratio value
- 7、 Write the corresponding panel value minus 100 into PA004.

8.6 Vibration Suppression

Specific resonance frequency can be obtained from PC upper computer software according to waveform monitoring, and filter frequency can be set to effectively suppress the oscillation ripple of a certain frequency in the current instruction.

The width of the notch is the ratio of the frequency of the notch center at a depth of 0 to the frequency range width of the attenuation rate of -3db.

The depth of the trap is: when the set value is 0, the input of the center frequency is completely disconnected; When the set value is 100, it represents the ratio of input and output that are completely passed.

Pr2.00	Name	Adaptive filter mode setup			Mode							F
	Range	0~4	Unit	-	Default	0	Index	2200h				
Set up the resonance frequency to be estimated by the adaptive filter and the special the operation after estimation.												
Setup value		content										
0		Adaptive filter: invalid				Parameters related to the 3rd and 4th notch filter hold the current value.						
1		Adaptive filter, 1 filter is valid, one time				One adaptive filter is valid, parameters related to the 3rd notch filter will be updated based on adaptive performance. After updated, Pr2.00 returns to 0, stop self-adaptation.						
2		Adaptive filter, 1 filter is valid, It will be valid all the time				One adaptive filter is valid, parameters related to the 3rd notch filter will be updated all the time based on adaptive performance.						
3-4		Not use				Non-professional forbidden to use						
Pr2.01	Name	1st notch frequency			Mode							F
	Range	50~2000	Unit	Hz	Default	2000	Index	2201h				
Set the center frequency of the 1st notch filter Notice: the notch filter function will be invalidated by setting up this parameter to "2000".												
Pr2.02	Name	1st notch width selection			Mode							F
	Range	0~20	Unit	-	Default	2	Index	2202h				
Set the width of notch at the center frequency of the 1st notch filter. Notice: Higher the setup, larger the notch width you can obtain. Use with default setup in normal operation.												
Pr2.03	Name	1st notch depth selection			Mode							F
	Range	0~99	Unit	-	Default	0	Index	2203h				
Set the depth of notch at the center frequency of the 1st notch filter. Notice: Higher the setup, shallower the notch depth and smaller the phase delay you can obtain.												
Pr2.04	Name	2nd notch frequency			Mode							F

	Range	50~2000	Unit	Hz	Default	2000	Index	2204h
Set the center frequency of the 2nd notch filter Notice: the notch filter function will be invalidated by setting up this parameter to “2000”.								
Pr2.05	Name	2nd notch width selection		Mode				F
	Range	0~20	Unit	-	Default	2	Index	2205h
Set the width of notch at the center frequency of the 2nd notch filter. Notice: Higher the setup, larger the notch width you can obtain. Use with default setup in normal operation.								
Pr2.06	Name	2nd notch depth selection		Mode				F
	Range	0~99	Unit	-	Default	0	Index	2206h
Set the depth of notch at the center frequency of the 2nd notch filter. Notice: Higher the setup, shallower the notch depth and smaller the phase delay you can obtain.								

Check the current command waveform on the upper computer. When the increase of rigidity causes the current command to produce the oscillation motor to scream, obtain its oscillation frequency from the waveform, and set the frequency to the notch frequency to debug the width and depth:

The notch width is described as follows:

notch width	notch width / notch frequency	notch width	notch width / notch frequency	notch width	notch width / notch frequency
0	0.50	7	1.68	14	5.66
1	0.59	8	2.00	15	6.73
2	0.71	9	2.38	16	8.00
3	0.84	10	2.83	17	9.51
4	1.00	11	3.36	18	11.31
5	1.19	12	4.00	19	13.45
6	1.41	13	4.76	20	16.00

8.7 Other Functions

8.7.1 Zero Speed Output (ZSP)

This function can be configured by IO output function parameters, as described in IO Pr4.10 parameters. When the enabling and time meet the setting conditions, the corresponding output IO port set can output ON

Pr4.34	Name	Zero-speed		Mode				F
	Range	10~2000	Unit	RPM	Default	50	Index	2434h

The rotation speed (RPM) was used to set the output timing sequence of the zero speed detection output signal (ZSP). When the motor speed is lower than the setting speed of this parameter, zero speed detection signal (ZSP) is output.

You can set up the timing to feed out the zero-speed detection output signal(ZSP or TCL) in rotate speed (r/min).
The zero-speed detection signal(ZSP) will be fed out when the motor speed falls below the setup of this parameter, Pr4.34

- the setup of pr4.34 is valid for both positive and negative direction regardless of the motor rotating direction.
- There is hysteresis of 10[r/min].

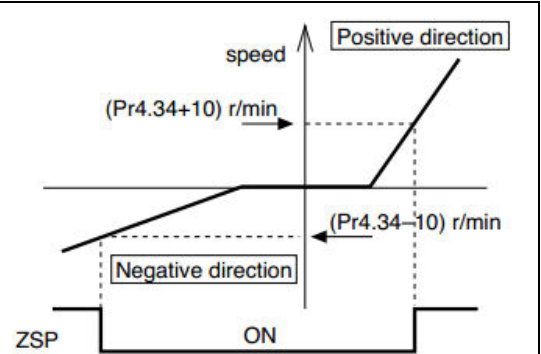

8.7.2 Position Setup Unit Select

Pr5.20	Name	Position setup unit select			Mode						F
	Range	0~2	Unit	—	Default	2	Index	2520h			
Specify the unit to determine the range of positioning complete and excessive positional deviation											
	Setup value	unit									
	0	Encoder unit									
	1	Command unit									
	2	Standard 2500-line unit									

8.7.3 EtherCAT slave ID

After setup Pr0.24 = 1, setup Pr0.23 manually.

Pr0.23 *	Name	EtherCAT slave ID			Mode						F
	Range	0~32767	Unit	—	Default	2	Index	2023h			
Setup the ID number of the slave station.											
Pr0.24 *	Name	Source of the slave ID			Mode						F
	Range	0~7	Unit	—	Default	0	Index	2024h			
1: The slave ID = Pr0.23											

8.7.4 Friction Torque compensation

Pr6.07	Name	Torque command additional value			Mode						F
	Range	-100~100	Unit	%	Default	0	Index	2607h			
Pr6.08	Name	Positive direction torque compensation value			Mode						F
	Range	-100~100	Unit	%	Default	0	Index	2608h			
Pr6.09	Name	Negative direction torque compensation value			Mode						F
	Range	-100~100	Unit	%	Default	0	Index	2609h			
These three parameters may apply feed forward torque superposition directly to torque command.											

Chapter 9 Alarm and Processing

9.1 Alarm List

Protection function is activated when an error occurs, the driver will stop the rotation of servo motor, and the front panel will automatically display the corresponding fault error code. The history of the error can be viewed on data monitoring mode. error logging submenu displays like:“d12Er”.

Table 9.1 Error Code List

Error code		Content	Attribute		
Main	Sub		Save	Immediate stop	Can be cleared
09	0~F	FPGA communication error	●		
0A	0~1	Current detection circuit error	●		
	3	Power line (U、V、W) not connected	●		
	5	DC bus circuit error	●		
	6	Temperature detection circuit error	●		
0c	0	DC bus over-voltage	●		●
0d	0	DC bus under-voltage	●		●
0e	0	Over-current	●		
	1	Over-current of intelligent power module (IPM)	●		
0F	0	Driver over-heat	●	●	
10	0	Motor over-load	●		●
	1	Driver over-load	●		
	5	Torque saturation alarm			
12	0	Resistor discharged circuit overload	●	●	
	1	Brake error			
15	0	Encoder wiring error	●		
	1	Encoder data error			
	2	Encoder initial position error	●		
	3	Encoder battery low-voltage error	●		
	5	Multi loop data hopping error			
	6	Encoder over-heated			
	7	Multi-turn encoder multi-turn data counting overflow error			
17	0	Encoder data error	●		
18	0	Encoder data error	●	●	●
	1	Motor parameter error	●	●	●
19	0	Too large position pulse deviation	●	●	●
1A	0	Too large velocity deviation	●	●	●
	1	Vibration is too large	●		●

1b	0	Position pulse input frequency error	●	●	●
	1	Electronic gear ratio error			
21	0	I/F input interface allocation error	●		
	1	I/F input interface function set error	●		
	2	I/F output interface function set error	●		
24	0	CRC verification error when EEPROM parameter saved			
	1	I2CCommunication status error			
	2	Read/write history alarm error			
	3	Read/write diagnostic data error			
	4	Read/write 402 parameters error			
	5	Read/write bus communication parameters error			
26	0	Positive/negative over-range input valid	●	●	●
57	0	E-stop input valid	●	●	●
5F	0	Motor code error			

Save: save this error history record

Emergency: error, driver will stop immediately

May remove: may through SI input/panel/software ACH Series remove alarm

Table 9.2 EtherCAT Error Code List

Error Code Display	1001h	603Fh	ETG Code	Error LED
Er 828	0x10	0x8728	0x0028	Single Flash
Er 82d	0x10	0x872D	0x002D	
Er 81A	0x10	0xFF02	0x871A	
Er 82E	0x10	0x872E	0x002E	
Er 836	0x10	0x8736	0x0036	
Er 832	0x10	0x8732	0x0032	
Er 81b	0x10	0x821B	0x001B	Double Flash
Er 818	0x10	0x8211	0x0018	
Er 819	0x10	0x8212	0x0019	
Er 82C	0x10	0x872C	0x002C	
Er 813	0x10	0x8213	0x0013	Flicking Flash
Er 850	0x80	0x5550	0x0050	
Er 851	0x80	0x5551	0x0051	
Er 801	0x10	0x8201	0x0001	Blinking Flash
Er 81C	0x10	0x821C	0x001C	
Er 811	0x10	0xA001	0x0011	
Er 812	0x10	0xA002	0x0012	
Er 816	0x10	0x8216	0x0016	
Er 815	0x10	0x8215	0x0015	

Er 81d	0x10	0x821D	0x001D	
Er 81E	0x10	0x821E	0x001E	
Er 821	0x10	0xA003	0x0021	
Er 822	0x10	0xA004	0x0022	
Er 823	0x10	0xA005	0x0023	
Er 824	0x10	0x8224	0x0024	
Er 825	0x10	0x8225	0x0025	
Er 82b	0x10	0x8210	0x002B	
Er 830	0x10	0x8730	0x0030	
Er 802	0x80	0x5510	0x0002	
Er 852	0x80	0x5552	0x0052	

9.2 Alarm Processing Method

When appear error, please clear error reason, renew power on.

Error code	Main	Extra	Display: “Er 090” -- “Er 09F”
	09	0~F	Content: FPGA communication error
Cause		Confirmation	Solution
L1,L2 terminal under-voltage		Check L1,L2 terminal voltage	Make sure voltage of L1,L2 terminal in proper range
Driver internal fault		/	replace the driver with a new one

Error code	Main	Extra	Display: “Er 0A0” -- “Er 0A1”
	0A	0~1	Content: current detection circuit error
Cause		Confirmation	Solution
Wiring error of motor output U,V,W terminal		Check wiring of motor output U,V,W terminal	Make sure motor U,V,W terminal wiring correctly
Main voltage L1,L2,L3 terminal voltage whether over-low		Check main voltage L1,L2,L3 terminal voltage	Make sure voltage of L1,L2,L3 terminal in proper range
Driver inner fault		/	replace the driver with a new one

Error code	Main	Extra	Display: “Er 0A3”
	0A	3	Content: Power line (U、V、W) not connected
Cause		Confirmation	Solution
Power line (U、V、W) not connected		Check wiring of U、V、W	Make sure U、V、W wiring correctly
Motor inner fault		/	replace the motor with a new one

Error code	Main	Extra	Display: “Er 0A5”
	0A	5	Content: DC bus circuit error
Cause		Confirmation	Solution

Main voltage L1,L2,L3 terminal under-voltage	Check L1,L2,L3 terminal voltage	Make sure voltage of L1,L2,L3 terminal in proper range
Driver inner fault	/	replace the driver with a new one

Error code	Main	Extra	Display: “Er 0A6”
	0A	6	Content: temperature detection circuit error
Cause		Confirmation	Solution
L1,L2,L3 terminal under-voltage		Check L1,L2,L3 terminal voltage	Make sure voltage of L1,L2,L3 terminal in proper range
Driver inner fault		/	replace the driver with a new one

Error code	Main	Extra	Display: “Er 0c0”
	0c	0	Content: DC bus over-voltage
Cause		Confirmation	Solution
Main power L1,L2,L3 terminal over-voltage		Check L1,L2,L3 terminal voltage	decrease L1,L2,L3 terminal Voltage
Inner brake circuit damaged		/	replace the driver with a new one
Driver inner fault		/	replace the driver with a new one

Error code	Main	Extra	Display: “Er 0d0”
	0d	0	Content: DC bus under-voltage
Cause		Confirmation	Solution
Main power L1,L2,L3 terminal under-voltage		Check L1,L2,L3 terminal voltage	increase L1,L2 terminal Voltage
Driver inner fault		/	replace the driver with a new one

Error code	Main	Extra	Display: “Er 0E0”
	0E	0	Content: over-current
Cause		Confirmation	Solution
Short of driver output wire		Short of driver output wire, whether short circuit to PG ground or not	Assure driver output wire no short circuit, assure motor no damage
Abnormal wiring of motor		Check motor wiring order	Adjust motor wiring sequence
Short of IGBT module		Cut off driver output wiring, make srv_on available and drive motor, check whether over-current exists	replace the driver with a new one
abnormal setting of control parameter		Modify the parameter	Adjust parameter to proper range
abnormal setting of control command		Check control command whether command changes too violently or not	Adjust control command: open filter function

Error code	Main	Extra	Display: “Er 0E1”
	0E	1	Content: IPM over-current
Cause		Confirmation	Solution
Short of driver output wire		Short of driver output wire, whether short circuit to PG ground or not	Assure driver output wire no short circuit, assure motor no damage

Abnormal wiring of motor	Check motor wiring order	Adjust motor wiring sequence
Short of IGBT module	Cut off driver output wiring, make srv_on available and drive motor, check whether over-current exists or not	replace the driver with a new one
Short of IGBT module	/	replace the driver with a new one
abnormal setting of control parameter	Modify the parameter	Adjust parameter to proper range
abnormal setting of control command	Check control command whether command changes too violently or not	Adjust control command: open filter function

Error code	Main	Extra	Display: “Er 0F0”
	0F	0	Content: driver over-heat
Cause		Confirmation	Solution
the temperature of power module have exceeded upper limit		Check driver radiator whether the temperature is too high or not	Strengthen cooling conditions, promote the capacity of driver and motor, enlarge acceleration/deceleration time, reduce load

Error code	Main	Extra	Display: “Er 100”
	10	0	Content: motor over-load
Cause		Confirmation	Solution
Load is too heavy		Check actual load if the value of parameter exceed maximum or not	Decrease load, adjust limit parameter
Oscillation of machine		Check the machine if oscillation exists or not	Modify the parameter of control loop; enlarge acceleration/deceleration time
wiring error of motor		Check wiring if error occurs or not, if line breaks or not	Adjust wiring or replace encoder/motor for a new one
electromagnetic brake engaged		Check brake terminal voltage	Cut off brake

Error code	Main	Extra	Display: “Er 120”
	12	0	Content: Resistance discharge circuit over-load
Cause		Confirmation	Solution
Regenerative energy has exceeded the capacity of regenerative resistor .		Check the speed if it is too high. Check the load if it is too large or not.	lower motor rotational speed; decrease load inertia ,increase external regenerative resistor, improve the capacity of the driver and motor
Resistance discharge circuit damage		/	Increase external regenerative resistor, replace the driver with a new one

Error code	Main	Extra	Display: “Er 150”
	15	0	Content: encoder line broken
Cause		Confirmation	Solution
Encoder line disconnected		check wiring if it steady or not	Make encoder wiring steady
Encoder wiring error		Check encoder wiring if it is correct or not	Reconnect encoder wiring
Encoder damaged		/	replace the motor with a new one
Encoder measuring circuit damaged		/	replace the driver with a new one

Error code	Main	Extra	Display: “Er 152”
	15	2	Content: initialized position of encoder error
Cause		Confirmation	Solution
Communication data abnormal		Check encoder power voltage if it is $DC5V \pm 5\%$ or not; check encoder cable and shielded line if it is damaged or not; check encoder cable whether it is intertwined with other power wire or not	Ensure power voltage of encoder normally, ensure encoder cable and shielded line well with FG ground, ensure encoder cable separated with other power wire
Encoder damaged		/	replace the motor with a new one
Encoder measuring circuit damaged		/	replace the driver with a new one

Error code	Main	Extra	Display: “Er 153”
	15	3	Content: encoder battery under voltage
Cause		Confirmation	Solution
Multi-turn absolute encoder power off		Check battery	Change a battery
		/Check motor	Motor damaged, replace the motor with a new one
		/Clear drive alarm	Clear alarm after changing battery

Error code	Main	Extra	Display: “Er 170”
	17	0	Content: encoder data error
Cause		Confirmation	Solution
Communication data abnormal		Check encoder power voltage if it is $DC5V \pm 5\%$ or not ; check encoder cable and shielded line if it is damaged or not; check encoder cable whether it is intertwined with other power wire or not	Ensure power voltage of encoder normally, ensure encoder cable and shielded line well with FG ground, ensure encoder cable separated with other power wire
Encoder damaged		/	replace the motor with a new one
Encoder measuring circuit damaged		/	replace the driver with a new one

Error code	Main	Extra	Display: “Er 180”
	18	0	Content: position error over-large error
Cause		Confirmation	Solution
Unreasonable set of position error parameter		Check parameter PA_014 value if it is too small or not	Enlarge the value of PA_014
Gain set is too small		Check parameter PA_100, PA_105 value if it is too small or not	Enlarge the value of PA_100, PA_105
Torque limit is too small		Check parameter PA_013, PA_522 value whether too small or not	Enlarge the value of PA_103, PA_522
Outside load is too large		Check acceleration/ deceleration time if it is too small or not , check motor rotational speed if it is too big or not ; check load if it is too large or not	Increase acceleration/ deceleration time decrease speed, decrease load

Error	Main	Extra	Display: “Er 181”
--------------	------	-------	--------------------------

code	18	1	Content: velocity error over-large error
Cause	Confirmation		Solution
The deviation of inner position command velocity is too large with actual speed	Check the value of PA_602 if it is too small or not		Enlarge the value of PA_602, or set the value to 0, make position deviation over-large detection invalid
The acceleration/ decelerate time Inner position command velocity is too small	Check the value of PA_312, PA_313 if it is too small or not		Enlarge the value of PA_312, PA_313. adjust gain of velocity control, improve trace performance.

Error code	Main	Extra	Display: “Er 190”
	19	0	Content: motor vibration
Cause	Confirmation		Solution
Current vibration	Current vibration		Cut down the value of Pr003. Pr004
Current loop is too strong	Current loop is too strong		

Error code	Main	Extra	Display: “Er 1A0”
	1A	0	Content: over-speed 1
Cause	Confirmation		Solution
Motor speed has exceeded the first speed limit (PA_321)	Check speed command if it is too large or not; check the value of PA_321 if it is too small or not; check input frequency and division frequency coefficient of command pulse if it is proper or not; check encoder if the wiring is correct or not		Adjust the value of input speed command, enlarge the value PA_321 value, modify command pulse input frequency and division frequency coefficient, assure encoder wiring correctly

Error code	Main	Extra	Display: “Er 1b0”
	1b	0	Content: input pulse format incorrect or out of frequency
Cause	Confirmation		Solution
The input pulse frequency is too high	Too high pulse frequency		To decrease pulse input frequency, less than 500K

Error code	Main	Extra	Display: “Er 1b1”
	1b	1	Content: incorrect electronic gear ratio
Cause	Confirmation		Solution
Out of range	Numerator denominator is zero, or setting values out of range		Reduce the number of pulses per revolution

Error code	Main	Extra	Display: “Er 210”
	21	0	Content: I/F input interface allocation error
Cause	Confirmation		Solution
The input signal are assigned with two or more functions.	Check the value of PA_400, PA_401, PA_402,PA_403,PA_404 if it is proper or not		Assure the value of PA_400, PA_401, PA_402, PA_403, PA_404 set correctly

The input signal aren't assigned with any functions.	Check the value of PA_400, PA_401,PA_402,PA_403,PA_404 if it is proper or not	Assure parameter PA_400, PA_401, PA_402,PA_403,PA_404 set correctly
--	---	---

Error code	Main	Extra	Display: “Er 211”
	21	1	Content: I/F input interface function set error
Cause		Confirmation	Solution
Signal allocation error		Check the value of PA_400, PA_401, PA_402,PA_403,PA_404 if it is proper or not	Assure the value of PA_400, PA_401, PA_402, PA_403, PA_404 set correctly

Error code	Main	Extra	Display: “Er 212”
	21	2	Content: I/F input interface function set error
Cause		Confirmation	Solution
The input signal are assigned with two or more functions.		Check the value of PA_410, PA_411, PA_412, PA_413, if it is proper or not	Assure the value of PA_410, PA_411, PA_412,PA_413 set correctly
The input signal aren't assigned with any functions.		Check the value of PA_410, PA_411, PA_412, PA_413, if it is proper or not	Assure the value of PA_410, PA_411,PA_412,PA_413 set correctly

Error code	Main	Extra	Display: “Er 240”
	24	0	Content: CRC verification error when EEPROM parameter is saved
Cause		Confirmation	Solution
L1,L2,L3 terminal under-voltage		Check L1,L2,L3 terminal voltage	Assure L1,L2,L3 terminal voltage in proper range
Driver is damaged		save the parameters again	replace the driver with a new one
The setting of driver maybe default setting which isn't suitable for motor .		Check the setting of driver if it is suitable for your motor	Download the suitable project file to driver for motor

Error code	Main	Extra	Display: “Er 260”
	26	0	Content: positive negative over-travel input valid
Cause		Confirmation	Solution
positive /negative over-travelling input signal has been conducted		Check the state of positive negative over-travel input signal	/

Error code	Main	Extra	Display: “ Er 570”
	57	0	Content: forced alarm input valid
Cause		Confirmation	Solution
Forced-alarm input signal has been conducted		Check forced-alarm input signal	Assure input signal wiring correctly

Error code	Main	Extra	Display: “Er 5F0”
	5F	0	Content: Motor code error
Cause		Confirmation	Solution

Motor code error	Motor code error	Set Pr7.15 correctly
------------------	------------------	----------------------

9.3 EtherCAT Communication Alarm

EtherCAT communication related alarms are erasable and will not be recorded in history.

9.4 Alarm clear

9.4.1 Servo Drive Alarm

For alarm can be cleared, There are 3 method.

Method 1:

- 1、 Write 1 to the object dictionary 4000h to clear the current alarm.
- 2、 By setting bit 7 of 6040h to 1, switches state machine from fault to initialization completion , No fault(Switch on disabled).

Method 2:

Use auxiliary function “AF_ACL”

- 1、 Press M to select auxiliary function , Press SET to enter into “AF_ACL” , Press and hold to clear the alarm

Method 3:

Set IO input function as Alarm clear input “ (A-CLR)”, refer to switch input interface connection to clear the alarm.

9.4.2 EtherCAT Communication Alarm

EtherCAT communication related alarms are erasable and will not be recorded in history.

EtherCAT communication alarm clear is similar to driver alarm clear, firstly clear the alarm itself, and then switch to the 402 state machine.

The communication alarm mainly relies on the register clearance of the main station, which follows the following process:

- 1、 Set the bit4 of ESC control register 0x120 (error responder) to 1.
- 2、 The communication alarm can be cleared until the feedback of the ESC status code register 0x134~0x135 is 0.
- 3、 By setting bit 7 of 6040h to 1, switches state machine from fault to initialization completion , No fault(Switch on disabled).

Contact us

China Headquarters

Address: 11/F, Block A3, iPark, No.1001 Xueyuan Blvd, Nanshan District, Shenzhen

Technical Support

Tel: 86-755-2641-8447

86-755-2641-8774 (for Asia, Australia, Africa areas)

86-755-2665-5136 (for America areas)

86-755-8654-2465 (for Europe areas)

Fax: 86-755-2640-2718

Email: tech@leadshine.com (for All)

Sales Hot Line

Tel: 86-755-2641-7674 (for Asia, Australia, Africa areas)

86-755-2640-9254 (for Europe areas)

86-755-2641-7617 (for America areas)

Email: sales@leadshine.com