

WIRING MOTOR CONNECTIONS

POWER CONNECTION

Function	DO	DO + Brake	C2	C3
U	PIN 1	PIN 1	PIN 1	PIN E
V	2	2	4	G
W	3	4	3	B
PE	4	5	2	D
BRAKE_24V	-	3	A	F
BRAKE_0V	-	6	B	A

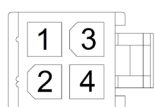

[DO]

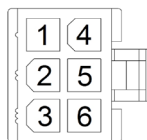

[DO + Brake]

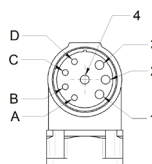

[C2]



[C3 for mod. TC-E 100 and 130]

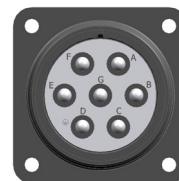

[C3 for mod. TC-E 180]

WIRING MOTOR CONNECTIONS

E1 FEEDBACK CONNECTION

D0 connection

C2 connection

C3 connection

Function

PIN

Function

PIN

Function

PIN

A	1
A/	2
B	3
B/	4
Z	5
Z/	6
HALL U	7
HALL U/	8
HALL V	9
HALL V/	10
HALL W	11
HALL W/	12
+5V	13
0V	14
SHIELD	15

HALL W	1
HALL U	2
0V	3
+5 Vdc	4
Ch /A	5
Ch A	6
Ch /z	7
Ch z	8
HALL V	9
SHIELD	10
Ch /B	11
Ch B	12
HALL /W	13
HALL /V	14
HALL /U	15

A	A
A/	B
B	C
B/	D
Z	E
Z/	F
HALL U	G
HALL U/	H
HALL V	J
HALL /V	K
HALL W	L
HALL /W	M
+5 Vdc	N
GND	P
SHIELD	R

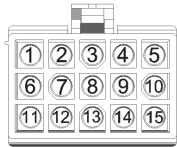

[D0]

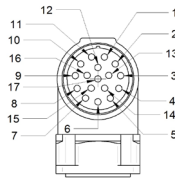

[C2]

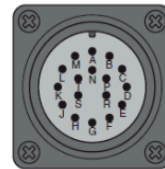

[C3]

WIRING MOTOR CONNECTIONS

A1 FEEDBACK CONNECTION

D0 connection

C2 connection

C3 connection

Function

PIN

DATA +	1
+ SIN	2
REFSIN	3
DATA -	4
+ COS	5
REFCOS	6
8V/ Us	7
GND	8
SHIELD	9

Function

PIN

GND	3
Us (+7Vdc ÷ +12Vdc)	4
REFSIN	5
+ SIN	6
DATA -	7
DATA +	8
SHIELD	10
REFCOS	11
+ COS	12

Function

PIN

8V/ Us	A
+ SIN	B
REFSIN	C
+ COS	D
REFCOS	E
GND	F
DATA -	G
DATA -	H
SHIELD	J

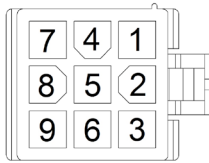

[D0]

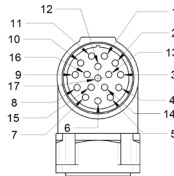

[C2]

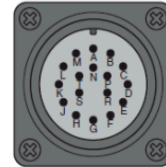

[C3]

A2 FEEDBACK CONNECTION

Function

D0 connection

C2 connection

C3 connection

DATA +
DATA -
-
-
-
-
DC +5V (BATTERY +)
GND (BATTERY -)
SHIELD

PIN

1
4
2
3
5
6
7
8
9

PIN

6
5
-
-
-
-
4
3
10

PIN

A
B
C
D
F
G
S
R
L

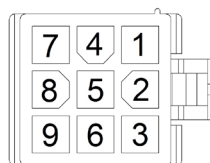

[D0]

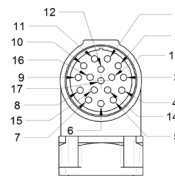

[C2]

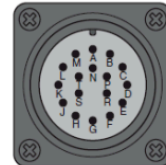

[C3]

SEE IT BEFORE IT HAPPENS

**MOTOR
POWER**
COMPANY

CABLES SPECIFICATIONS

Dynamic laying cable E83517 – cRUus AWM STYLE 21223 certified

POWER CABLES for models TC-E 40-60-80 without holding brake for DO connection

PIN motor side	FUNCTION	Cable wire colour	For cable order	
1	FASE U	Black 1	Length (mm)	Order code
4	FASE V	Black 2		
7	FASE W	Black 3		
8	PE	Yellow-Green		
			3000	003108015156
			5000	003108015157
			10000	003108015155

Power free wire cable for FLEXI-PRO and general purpose

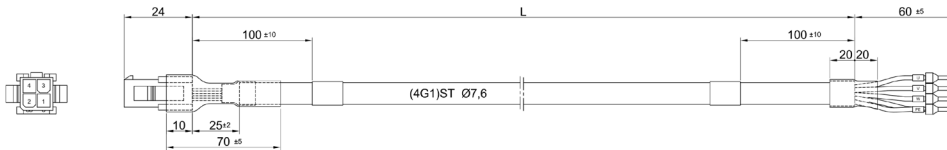

POWER CABLES for models TC-E 40-60-80 with holding brake for DO connection

PIN motor side	FUNCTION	Cable wire colour	For cable order	
1	FASE U	Black 1	Length (mm)	Order code
2	FASE V	Black 2		
4	FASE W	Black 3		
5	PE	Yellow-Green		
3	BRAKE 1	Brown	3000	003108015159
6	BRAKE 2	White	5000	003108015160
			10000	003108015158

Power free wire cable for FLEXI-PRO and general purpose

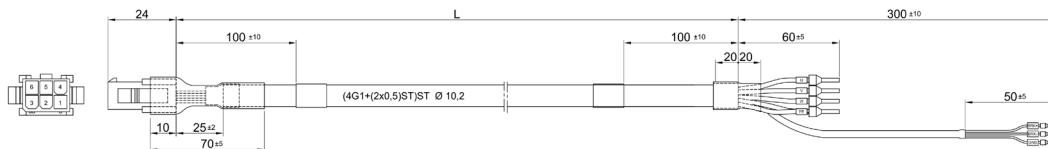

POWER CABLES for models TC-E 100 4A - 130 5A - 130 5B - 130 5C - 130 5D - 130 5E - 130 5F - 130 5G without holding brake for C3 connection

PIN motor side	FUNCTION	Cable wire colour	For cable order	
E	FASE U	White	Length (mm)	Order code
G	FASE V	Black		
B	FASE W	Red		
D	PE	Yellow-Green		
			3000	003108015244
			5000	003108015245
			10000	003108015246

Power free wire cable for FLEXI-PRO and general purpose

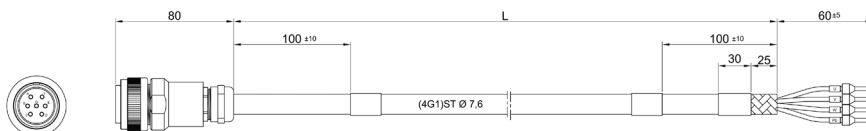

SEE IT BEFORE IT HAPPENS

**MOTOR
POWER**
COMPANY

CABLES SPECIFICATIONS

Dynamic laying cable E83517 – cRUus AWM STYLE 21223 certified

POWER CABLES for models TC-E 100 4A - 130 5A - 130 5B - 130 5C - 130 5D - 130 5E - 130 5F - 130 5G with holding brake for C3 connection

PIN motor side	FUNCTION	Cable wire colour	For cable order	
E	FASE U	White	Lenght (mm)	Order code
G	FASE V	Black		
B	FASE W	Red	3000	003108015247
D	PE	Yellow-Green	5000	003108015248
F	BK +	Red	10000	003108015249
A	BK -	Black		

Power free wire cable for FLEXI-PRO and general purpose

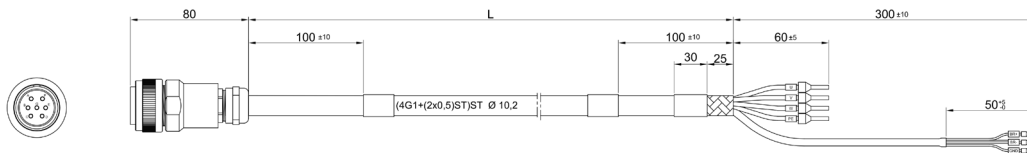

POWER CABLES for models TC-E 100 4B - 130 5H without holding brake for C3 connection

PIN motor side	FUNCTION	Cable wire colour	For cable order	
E	FASE U	White	Lenght (mm)	Order code
G	FASE V	Black		
B	FASE W	Red	1500	003108015164
D	PE	Yellow-Green	3000	003108015165
			5000	003108015166
			10000	003108015228

Power free wire cable for FLEXI-PRO and general purpose

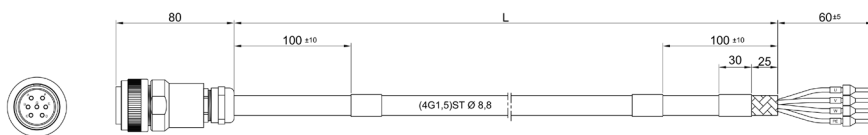

POWER CABLES for models TC-E 100 4B - 130 5H with holding brake for C3 connection

PIN motor side	FUNCTION	Cable wire colour	For cable order	
E	FASE U	White	Lenght (mm)	Order code
G	FASE V	Black		
B	FASE W	Red	3000	003108015168
D	PE	Yellow-Green	5000	003108015169
F	BK +	Red	10000	003108015167
A	BK -	Black		

Power free wire cable for FLEXI-PRO and general purpose

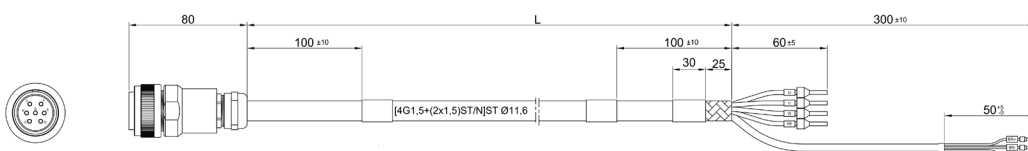

SEE IT BEFORE IT HAPPENS

**MOTOR
POWER**
COMPANY

CABLES SPECIFICATIONS

Dynamic laying cable E83517 – cRUus AWM STYLE 21223 certified

POWER CABLES for models TC-E 180 6A - 180 6B - 180 6C - 180 6D without holding brake for C3 connection

PIN motor side	FUNCTION	Cable wire colour	For cable order	
1	FASE U	Black 1	Lenght (mm)	Order code
4	FASE V	Black 2	3000	003108015177
7	FASE W	Black 3	5000	003108015178
8	PE	Yellow-Green	10000	003108015176

Power free wire cable for FLEXI-PRO and general purpose

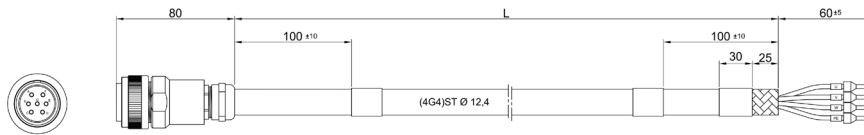

POWER CABLES for models TC-E 180 6A - 180 6B - 180 6C - 180 6D with holding brake for C3 connection

PIN motor side	FUNCTION	Cable wire colour	For cable order	
E	FASE U	White	Lenght (mm)	Order code
G	FASE V	Black	3000	003108015180
B	FASE W	Red	5000	003108015181
D	PE	Yellow-Green	10000	003108015179
F	BK +	Red		
A	BK -	Black		

Power free wire cable for FLEXI-PRO and general purpose

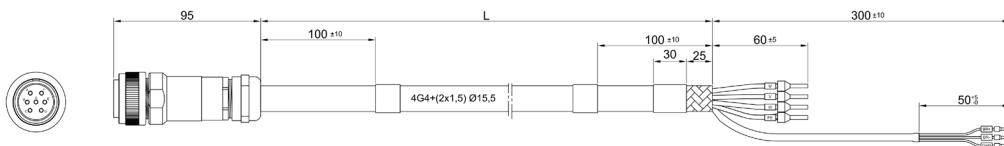

SEE IT BEFORE IT HAPPENS

CABLES SPECIFICATIONS

Dynamic laying cable E83517 – cRUus AWM STYLE 21223 certified

POWER CABLES for models TC-E 180 6E - 180 6F - 180 6G without holding brake for C3 connection

PIN motor side	FUNCTION	Cable wire colour	For cable order	
1	FASE U	Black 1	Lenght (mm)	Order code
4	FASE V	Black 2		
7	FASE W	Black 3	3000	003108015183
8	PE	Yellow-Green	5000	003108015184
			10000	003108015182

Power free wire cable for FLEXI-PRO and general purpose

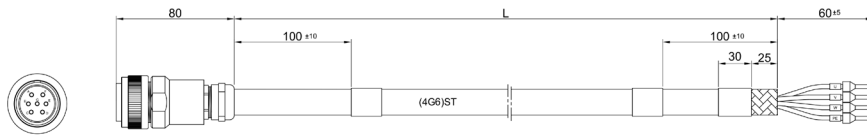

POWER CABLES for models TC-E 180 6E - 180 6F - 180 6G with holding brake for C3 connection

PIN motor side	FUNCTION	Cable wire colour	For cable order	
E	FASE U	White	Lenght (mm)	Order code
G	FASE V	Black		
B	FASE W	Red	3000	003108015186
D	PE	Yellow-Green	5000	003108015187
F	BK +	Red	10000	003108015185
A	BK -	Black		

Power free wire cable for FLEXI-PRO and general purpose

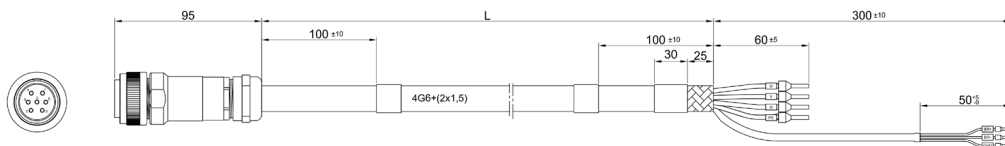

SEE IT BEFORE IT HAPPENS

**MOTOR
POWER**
COMPANY

CABLES SPECIFICATIONS

Dynamic laying cable E83517 – cЯUus AWM STYLE 21223 certified

POWER CABLES for models TC-E 60- 80 -100 4A - 130 5A - 130 5B - 130 5C - 130 5D - 130 5E - 130 5F - 130 5G without holding brake for C2 connection

PIN motor side	FUNCTION	Cable wire colour	For cable order	
1	FASE U	Black	Lenght (mm)	Order code
4	FASE V	Black		
3	FASE W	Black		
2	PE	Yellow-Green		
			3000	003108015250
			5000	003108015251
			10000	003108015252

Power free wire cable for FLEXI-PRO and general purpose

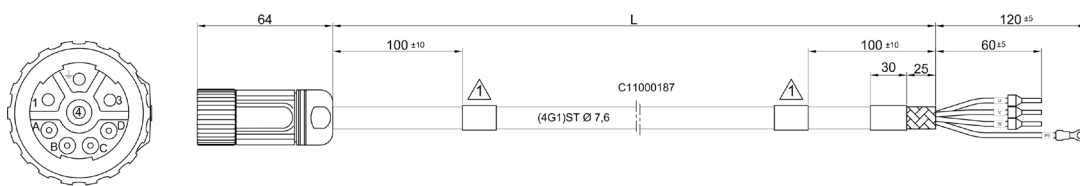

POWER CABLES for models TC-E 60 - 80 - 100 4A - 130 5A - 130 5B - 130 5C - 130 5D - 130 5E - 130 5F - 130 5G with holding brake for C2 connection

PIN motor side	FUNCTION	Cable wire colour	For cable order	
1	FASE U	Black	Lenght (mm)	Order code
4	FASE V	Black		
3	FASE W	Black		
2	PE	Yellow-Green		
A	BK +	Black	3000	003108015253
B	BK -	White	5000	003108015254
			10000	003108015255

Power free wire cable for FLEXI-PRO and general purpose

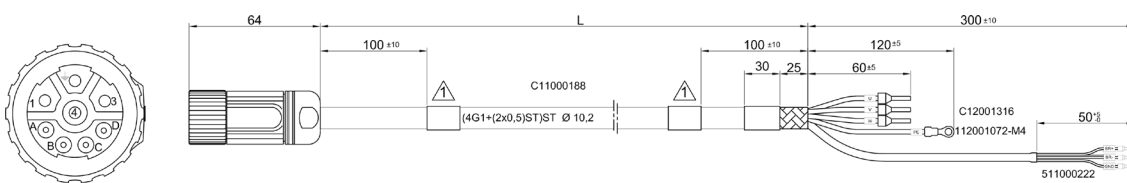

POWER CABLES for models TC-E 100 4B - 130 5H without holding brake for C2 connection

PIN motor side	FUNCTION	Cable wire colour	For cable order	
1	FASE U	Black	Lenght (mm)	Order code
4	FASE V	Black		
3	FASE W	Red		
2	PE	Black		
			3000	003108015192
			5000	003108015193
			10000	003108015191

Power free wire cable for FLEXI-PRO and general purpose

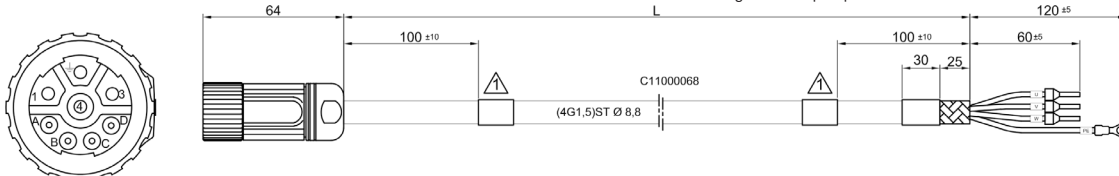

CABLES SPECIFICATIONS

Dynamic laying cable E83517 – cRUus AWM STYLE 21223 certified

POWER CABLES for models TC-E 100 4B - 130 5H with holding brake for C2connection

PIN motor side	FUNCTION	Cable wire colour	For cable order	
1	FASE U	Black	Length (mm)	Order code
4	FASE V	Black	3000	003108015195
3	FASE W	Black	5000	003108015196
2	PE	Yellow-Green	10000	003108015194
A	BK +	Black		
B	BK -	White		

Power free wire cable for FLEXI-PRO and general purpose

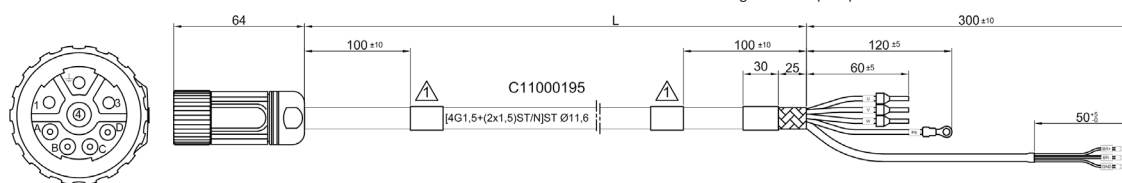

POWER CABLES for models TC-E 180 6A - 180 6B - 180 6C - 180 6D without holding brake for C2 connection

PIN motor side	FUNCTION	Cable wire colour	For cable order	
1	FASE U	Black	Length (mm)	Order code
4	FASE V	Black	3000	003108015204
3	FASE W	Black	5000	003108015205
2	PE	Yellow-Green	10000	003108015203

Power free wire cable for FLEXI-PRO and general purpose

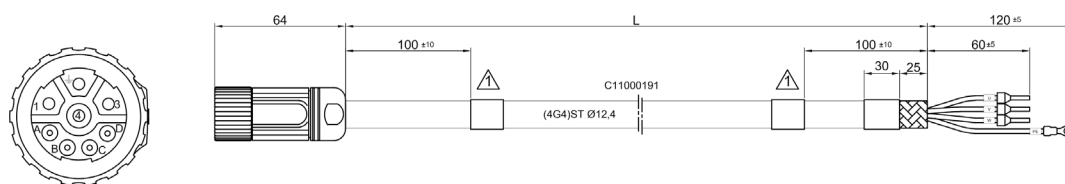

POWER CABLES for models TC-E 180 6A - 180 6B - 180 6C - 180 6D with holding brake for C2 connection

PIN motor side	FUNCTION	Cable wire colour	For cable order	
1	FASE U	Black	Length (mm)	Order code
4	FASE V	Black	3000	003108015207
3	FASE W	Black	5000	003108015208
2	PE	Yellow-Green	10000	003108015206
A	BK +	Black		
B	BK -	White		

Power free wire cable for FLEXI-PRO and general purpose

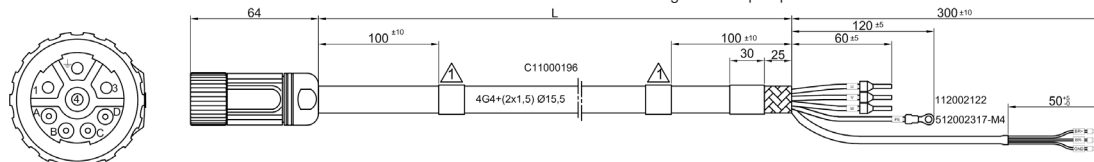

CABLES SPECIFICATIONS

Dynamic laying cable E83517 cULus AWM STYLE 20233 and E83517 – cRUus AWM STYLE 20549 certified

SIGNAL CABLES for models TC-E 40-60-80 feedback A1 absolute multiturn encoder for DO connection

PIN motor side	FUNCTION	PIN drive side	For cable order			
1	DATA +	1	Length (mm)	Order code		
2	SIN +	9			3000	003108015210
3	SIN -	22			5000	003108015211
4	DATA -	14	10000	003108015209		
5	COS +	10				
6	COS -	23				
7	8 VDC	18				
8	GND	24				
9	SHIELD	26				

Signal wired cable for FLEXI-PRO with absolute multiturn encoder

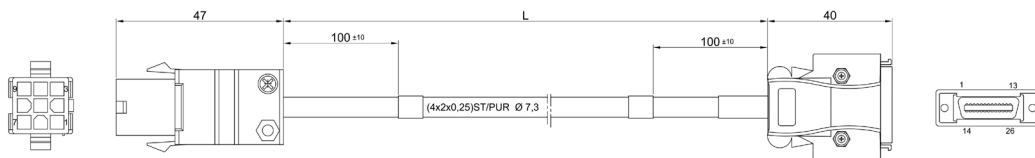

SIGNAL CABLES for models TC-E 40-60-80 feedback E1 incremental encoder for DO connection

PIN motor side	FUNCTION	PIN drive side	For cable order			
1	A	1	Length (mm)	Order code		
2	A/	14			3000	003108015219
3	B	2			5000	003108015220
4	B/	15	10000	003108015218		
5	Z	3				
6	Z/	16				
7	HU	4				
8	HU/	NC				
9	HV	17				
10	HV/	NC				
11	HW	5				
12	HW/	NC				
13	5 VDC	11				
14	GND	24				
15	SHIELD	26				

Signal wired cable for FLEXI-PRO with incremental encoder

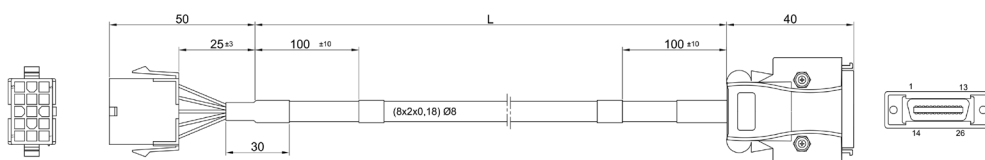

CABLES SPECIFICATIONS

Dynamic laying cable E83517 cULus AWM STYLE 20233 and E83517 – cRUus AWM STYLE 20549 certified

SIGNAL CABLES for models TC-E 40-60-80 feedback A2 20 bit absolute encoder for D0 connection

PIN motor side	FUNCTION	PIN drive side	For cable order	
1	DATA +	1	Lenght (mm)	Order code
4	DATA -	14	3000	003108015162
7	5 VDC	11	5000	003108015163
8	GND	24	10000	003108015161
9	SHIELD	26		

Signal wired cable for FLEXI-PRO with 20 bit absolute encoder

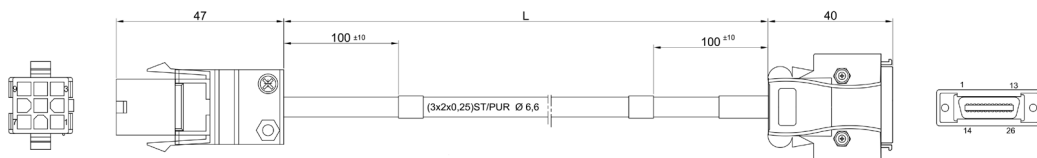

SIGNAL CABLES for models TC-E 100 - 130 - 180 feedback A1 absolute multiturn encoder for C3 connection

PIN motor side	FUNCTION	PIN drive side	For cable order	
A	8 VDC	18	Lenght (mm)	Order code
B	SIN +	9	3000	003108015213
C	SIN -	22	5000	003108015214
D	COS +	10	10000	003108015212
E	COS -	23		
F	GND	24		
G	DATA +	1		
H	DATA -	14		
J	SHIELD	26		

Signal wired cable for FLEXI-PRO with absolute multiturn encoder

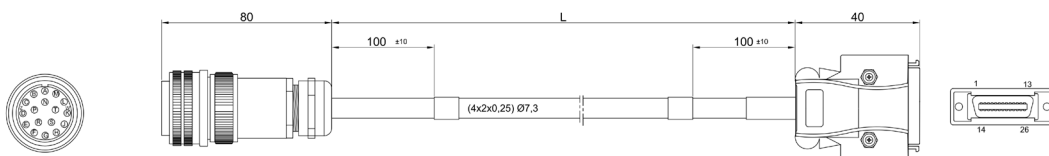

CABLES SPECIFICATIONS

Dynamic laying cable E83517 cULus AWM STYLE 20233 and E83517 – cRUus AWM STYLE 20549 certified

SIGNAL CABLES for models TC-E 100 - 130 - 180 feedback E1 incremental encoder for C3 connection

PIN motor side	FUNCTION	PIN drive side	For cable order	
A	A	1	Length (mm)	Order code
B	A/	14		
C	B	2	3000	003108015222
D	B/	15	5000	003108015223
E	Z	3	10000	003108015221
F	Z/	16		
G	HU	4		
H	HU/	NC		
J	HV	17		
K	HV/	NC		
L	HW	5		
M	HW/	NC		
N	5 VDC	11		
P	GND	24		
Q	SHIELD	26		

Signal wired cable for FLEXI-PRO with incremental encoder

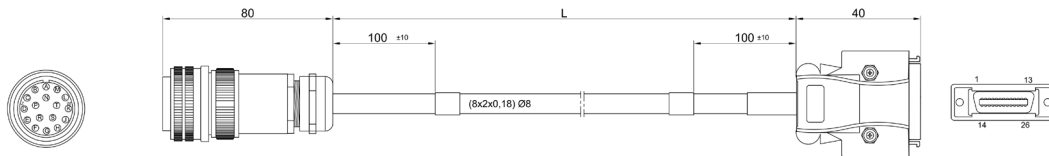

SIGNAL CABLES for models TC-E 100 - 130 - 180 feedback A2 20 bit absolute encoder for C3 connection

PIN motor side	FUNCTION	PIN drive side	For cable order	
A	DATA +	1	Length (mm)	Order code
B	DATA -	14		
S	5 VDC	11	1500	003108015188
R	GND	24	3000	003108015189
L	SHIELD	26	5000	003108015190
			10000	003108015227

Signal wired cable for FLEXI-PRO with 20 bit absolute encoder

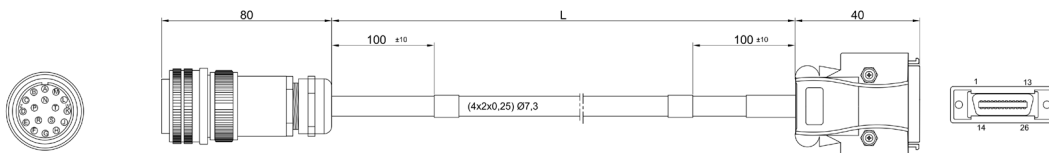

CABLES SPECIFICATIONS

Dynamic laying cable E83517 cULus AWM STYLE 20233 and E83517 – cRUus AWM STYLE 20549 certified

SIGNAL CABLES for models TC-E 60 - 80 - 100 - 130 - 180 feedback A1 absolute multiturn encoder for C2 connection

PIN motor side	FUNCTION	PIN drive side	For cable order	
4	8 VDC	18	Lenght (mm)	Order code
6	SIN +	9		
5	SIN -	22	3000	003108015216
12	COS +	10	5000	003108015217
11	COS -	23	10000	003108015215
3	GND	24		
8	DATA +	1		
7	DATA -	14		
10	SHIELD	26		

Signal wired cable for FLEXI-PRO with absolute multiturn encoder

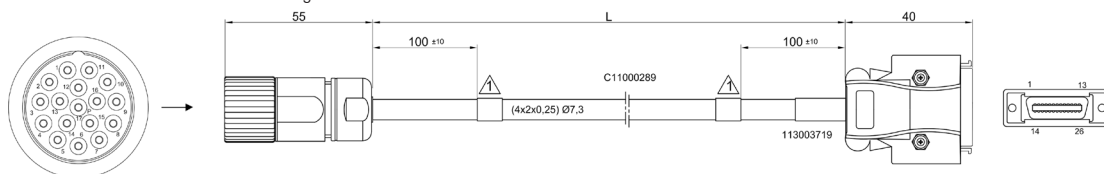

SIGNAL CABLES for models TC-E 60 - 80 - 100 - 130 - 180 feedback E1 incremental encoder for C2 connection

PIN motor side	FUNCTION	PIN drive side	For cable order	
6	A	1	Lenght (mm)	Order code
5	A/	14		
12	B	2	3000	003108015225
11	B/	15	5000	003108015226
8	Z	3	10000	003108015224
7	Z/	16		
2	HU	4		
15	HU/	NC		
9	HV	17		
14	HV/	NC		
1	HW	5		
13	HW/	NC		
4	5 VDC	11		
3	GND	24		
10	SHIELD	26		

Signal wired cable for FLEXI-PRO with incremental encoder

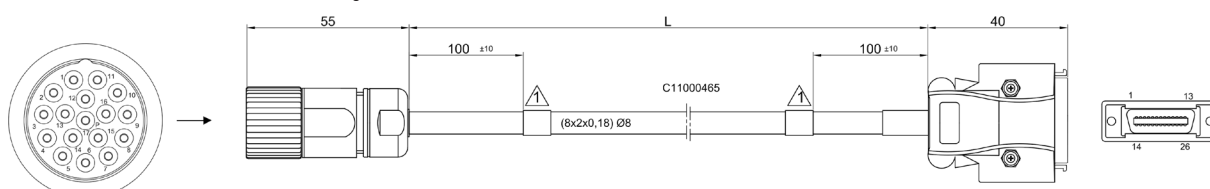

CABLES SPECIFICATIONS

Dynamic laying cable E83517 cULus AWM STYLE 20233 and E83517 – cRUus AWM STYLE 20549 certified

SIGNAL CABLES for models TC-E 60 - 80 - 100 - 130 - 180 feedback A2 20 bit absolute encoder for C2 connection

PIN motor side	FUNCTION	PIN drive side	For cable order	
6	DATA +	1	Lenght (mm)	Order code
5	DATA -	14	3000	003108015230
4	5 VDC	11	5000	003108015231
3	GND	24	10000	003108015229
10	SHIELD	26		

Signal wired cable for FLEXI-PRO with 20 bit absolute encoder

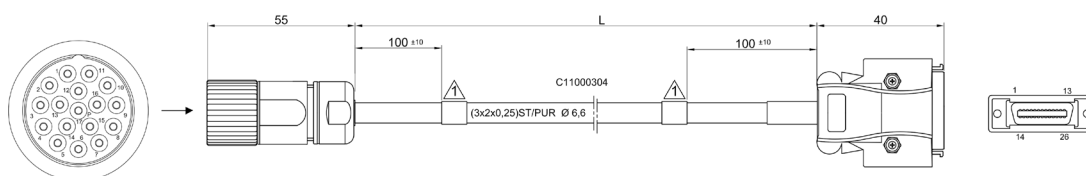

SEE IT BEFORE IT HAPPENS

CONNECTOR SPECIFICATIONS

FLYING CONNECTORS for D0 connection

Power Connector
for TC-E 40-60-80 Molex 4p

order code 007117000088

Power Connector
for TC-E 40-60-80 with brake Molex 6p

order code 007117000086

Signal Connector
for TC-E 40-60-80 Amp 9p

order code 007117000084

FLYING CONNECTORS FOR C2 connection

Power connector pin included
BSTA108NN00580236000 + 4 PIN 60.003.11 FM/2mm
CRIMP.0,35-2,5 SPRING + 4 PIN 60.001.11 FM/1mm
CRIMP.0,14-1 SPRING

order code 007117000472



Signal connector pin included
ASTA014NN00410235000 17p/FM + 17 PIN 60.011.11
FM/1mm CRIMP.0,14-1

order code 007117000462



FLYING CONNECTORS for C3 connection

Signal Connector for TC-E 100, 130, 180
97-3106AMI20- 29S(417)(946)(M16)(A99)
cable gland included

order code 005117001770

Power Connector for TC-E 100 and 130
DL31.06A.20-15S (PG16)
cable gland not included

power connector order code 005117001766
cable gland order code 005603000170

Power Connector for TC-E 180
DLC31.06A.24-10S (PG21)
cable gland not included

order code 005117001768
cable gland order code 005603000300

FLYING CONNECTOR DIMENSIONS

FLYING CONNECTORS for C2 connection (90° M23 turnable connectors)

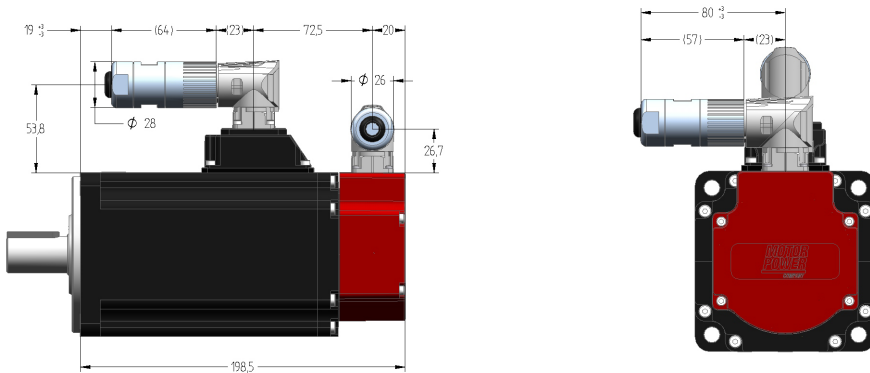

FLYING CONNECTORS for C3 connection for TC-E 100-130 (90° MS connectors)

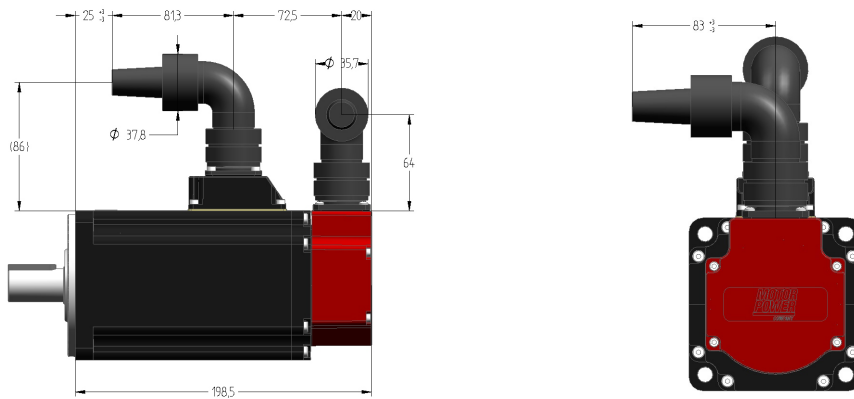

FLYING CONNECTORS for C3 connection for TC-E 180 (90° MS connectors)

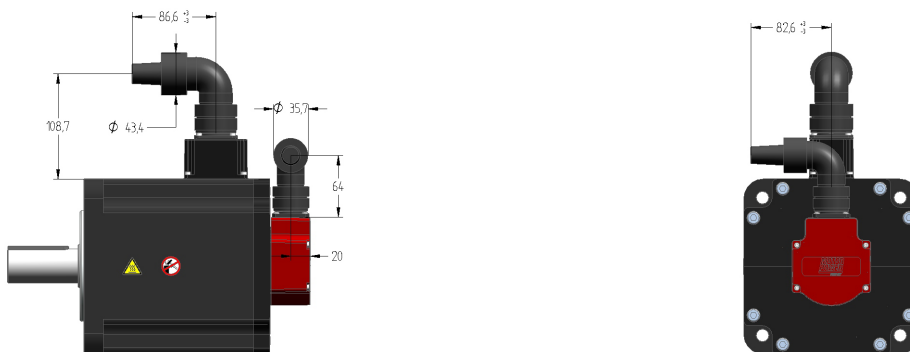

FLYING CONNECTORS for C3 connection for MS connectors

Radius curvature $RD=10 \times D$ and $Rd = 10 \times d$

TC-E 100 and 130

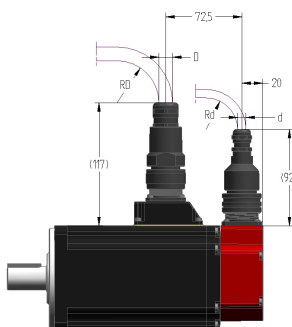

TC-E 180

