

Programming and Software Reference for:

- **MCode**
- **MCode/TCP**

MDrive, MForce and
Hybrid Motion Control
Products

MCode Programming and Software Reference		
Date	Revision	Changes
03/08/2006	R030806	Initial Release
02/16/2007	R021607	Added TR as a reserved for future use word.
04/20/2007	R042007	Revised manual to reflect firmware version MDI3.006. Added D5, analog input filter variable, various corrections and expansions of commands, updated error table.
10/25/2007	R102507	Revised manual to reflect firmware version MDI3.007
02/27/2008	R022708	Revised Manual to reflect firmware version MDI3.008. Added QD (Queued - Page 45) command and PW variable (Page 44 and Appendix G: MForce PWM Current Control).
06/16/08	R061608	Updated covers, added disclaimer information. Expanded on Trip definitions. Expanded on Error 92. Minor corrections throughout.
08/14/2008	R081408	Added NE (Numeric Enable Command. Relevant to Firmware Version 3.009
04/29/2009	R080409	Added Hybrid commands, reformatted to reflect current documentation standards and styling. Updated to reflect firmware release 3.010.
08/04/2009	R080409	Added Error 63 - character overrun
07/10/2009	R071009	Added Hybrid Flag AF, added errors 87, 88 and 89 for Hybrid
11/23/2009	R112309	Appended the HT (Hold Current Delay Time) command to reflect the behavioral difference between Legacy and Plus MDrive units.
02/25/2010	R022510	Updates and corrections throughout.
07/02/2010	R070210	Updates and corrections throughout. Added warning about enabling clock mode when using limits (pg 5-12).
10/05/2010	R100510	Added support for MDrive Ethernet products. Section 6: IMS Terminal renamed to Section 6: Supporting Software with the addition of instructions for the TCP/IP Configuration Utility for MDrive Ethernet and MDrive Hybrid Ethernet. Changed name of MDrive AccuStep to MDrive Hybrid throughout.
02/14/2011	R021411	Added procedure for upgrading Ethernet Controller firmware for Ethernet equipped MDrivePlus and MDrive Hybrid models.
04/12/2011	R041211	Added support for MDrive Hybrid firmware version 4.004
08/05/2011	R080511	Added second parameter details supporting hybrid calibration. Added correct range for torque speed and system speed.
06/28/2012	R062812	Added changes supporting default MDrive Hybrid calibration method.

The information in Schneider Electric Motion USA product documentation and on this web site has been carefully checked and is believed to be accurate; however, no responsibility is assumed for inaccuracies.

Schneider Electric Motion USA reserves the right to make changes without further notice to any products to improve reliability, function or design. Schneider Electric Motion USA does not assume any liability arising out of the application or use of any product or circuit described; neither does it convey any license under its patent rights of others.

Schneider Electric Motion USA's general policy does not recommend the use of its products in life support or aircraft applications wherein a failure or malfunction of the product may directly threaten life or injury. Per the terms and conditions of sales of Schneider Electric Motion USA, the user of Schneider Electric Motion USA products in life support or aircraft applications assumes all risks of such use and indemnifies Schneider Electric Motion USA against all damages. aircraft applications assumes all risks of such use and indemnifies Schneider Electric Motion USA against all damages.

Important information

The drive systems described here are products for general use that conform to the state of the art in technology and are designed to prevent any dangers. However, drives and drive controllers that are not specifically designed for safety functions are not approved for applications where the functioning of the drive could endanger persons. The possibility of unexpected or un-braked movements can never be totally excluded without additional safety equipment. For this reason personnel must never be in the danger zone of the drives unless additional suitable safety equipment prevents any personal danger. This applies to operation of the machine during production and also to all service and maintenance work on drives and the machine. The machine design must ensure personal safety. Suitable measures for prevention of property damage are also required.

Qualification of personnel

Only technicians who are familiar with and understand the contents of this manual and the other relevant documentation are authorized to work on and with this drive system. The technicians must be able to detect potential dangers that may be caused by setting parameters, changing parameter values and generally by the operation of mechanical, electrical and electronic equipment.

The technicians must have sufficient technical training, knowledge and experience to recognise and avoid dangers.

The technicians must be familiar with the relevant standards, regulations and safety regulations that must be observed when working on the drive system.

Intended Use

The drive systems described here are products for general use that conform to the state of the art in technology and are designed to prevent any dangers. However, drives and drive controllers that are not specifically designed for safety functions are not approved for applications where the functioning of the drive could endanger persons. The possibility of unexpected or unbraked movements can never be totally excluded without additional safety equipment.

For this reason personnel must never be in the danger zone of the drives unless additional suitable safety equipment prevents any personal danger. This applies to operation of the machine during production and also to all service and maintenance work on drives and the machine. The machine design must ensure personal safety. Suitable measures for prevention of property damage are also required.

In all cases the applicable safety regulations and the specified operating conditions, such as environmental conditions and specified technical data, must be observed.

The drive system must not be commissioned and operated until completion of installation in accordance with the EMC regulations and the specifications in this manual. To prevent personal injury and damage to property damaged drive systems must not be installed or operated.

Changes and modifications of the drive systems are not permitted and if made all no warranty and liability will be accepted.

The drive system must be operated only with the specified wiring and approved accessories. In general, use only original accessories and spare parts.

The drive systems must not be operated in an environment subject to explosion hazard (ex area).

This page intentionally left blank

Table of Contents

	Important information	3
	Qualification of personnel.....	3
	Intended Use.....	3
1	Introduction.....	1-1
	1.1 About this manual.....	1-1
	1.2 MCode device overview	1-1
	1.3 Documentation reference	1-1
	1.4 Product software	1-1
	1.4.1 Communications converter drivers	1-1
	1.4.2 ASCII program editor and ANSI terminal emulator.	1-1
2	Safety.....	2-1
	2.1 Qualification of personnel.....	2-1
	2.2 Intended Use	2-1
	2.3 Hazard Categories	2-2
	2.4 General safety instructions.....	2-2
3	Introduction to MCode programming	3-1
	3.1 Operational modes	3-1
	3.2 Basic components of MCode software.....	3-1
	3.2.1 Instructions	3-1
	3.2.2 Variables.....	3-2
	3.2.3 Flags	3-3
	3.2.4 Keywords	3-3
	3.2.5 Math functions	3-4
	3.3 Program structuring.....	3-4
	3.3.1 Programming aids.....	3-5
	3.4 Commonly used variables and instructions.....	3-6
	3.4.1 Variables.....	3-6
	3.4.2 Motion instructions.....	3-7
	3.4.3 I/O instructions.....	3-9
	3.4.4 System instructions.....	3-10
	3.4.5 Program instructions.....	3-11
4	Command summary	4-1
	4.1 Setup instructions, variables and flags	4-1
	4.2 Misc instructions, variables and flags	4-2
	4.3 Motion instructions, variables and flags.....	4-3
	4.4 Program instructions, variables and flags.....	4-4
	4.5 I/O instructions, variables and flags.....	4-5
	4.6 Position related instructions, variables and flags.....	4-6
	4.7 Encoder related instructions, variables and flags ...	4-6
	4.8 Hybrid specific instructions, variables and flags	4-7
	4.9 Math functions	4-8
5	MCode command details	5-1
	A (Acceleration).....	5-1
	AL (Retrieve all parameters)	5-1
	AF (Hybrid flags)	5-2
	AS (Hybrid mode).....	5-3
	AT (Reservef).....	5-3
	BD (Communications BAUD rate).....	5-4
	BP (Break point).....	5-5

BR (Program branch)	5-6
BY (Program executing).....	5-6
C1 (Counter 1)	5-7
C2 (Counter 2)	5-7
CA (Calibration mode).....	5-8
CB (Control bounds)	5-9
CC (Calibration current)	5-9
CE (Software reset enable).....	5-10
CF (Clear locked rotor fault).....	5-10
CK (Check sum enable).....	5-11
CL (Call subroutine)	5-12
CM (Clock mode enable)	5-12
CP (Clear program).....	5-13
CR (Clock ratio).....	5-13
CT (Calibration time).....	5-14
CW (Clock width)	5-14
D (Deceleration).....	5-15
D1-D4 (Input switch debounce).....	5-15
D5 (Analog input filter)	5-16
D9-D12 (Input switch debounce).....	5-16
DB (Encoder deadband)	5-17
DC (Decrement variable)	5-17
DE (Drive enable).....	5-18
DG (Disable global response)	5-18
DN (Device name).....	5-19
E (End program).....	5-19
EE (Encoder enable).....	5-20
EF (Error flag)	5-20
EL (Remote encoder line count)	5-21
EM (Echo mode)	5-21
ER (Device name).....	5-22
ES (Escape)	5-22
EX (Execute program).....	5-23
FC (Filter capture)	5-24
FD (Restore factory defaults)	5-25
FM (Filter motion).....	5-25
FT (Internal use only)	5-26
H (Hold program execution)	5-26
HC (Motor holding current).....	5-27
HI (Home to index mark)	5-28
HM (Home to home switch).....	5-29
HT (Hold current delay time).....	5-31
I1, I2, I3 and I4 (Read inputs 1, 2, 3 or 4)	5-31
I5 (Read analog input).....	5-32
I6 (Read encoder index mark).....	5-32
I7, I8 (Reserved)	5-32
I9, I10, I11 and I12 (Read inputs 9, 10, 11 or 12)	5-33
I13 (Reserved)	5-33
IC (Increment variable).....	5-33
IF (Input variable pending)	5-34
IL (Read inputs 1 - 4 as a group)	5-34
IH (Read inputs 9 - 12 as a group).....	5-35
IN (Read inputs 1 - 4 and 9 - 12 as a group).....	5-35
IP (Initialize parameters)	5-36
IT (Read internal temperature).....	5-36
IV (Input to variable).....	5-37
JE (Jog enable).....	5-37

L (List program space)	5-38
LB (Label program or subroutine)	5-38
LD (Lead limits)	5-39
LG (Lag limits)	5-39
LL (Position lead/lag)	5-40
LK (Lock user program)	5-40
LM (Limit stop modes)	5-41
LR (Locked rotor)	5-42
LT (Locked rotor timeout)	5-42
MA (Move to an absolute position)	5-43
MD (Motion mode)	5-43
MF (Make up frequency)	5-44
MP (Moving to position)	5-44
MR (Move to a relative position)	5-45
MS (Microstep resolution select)	5-46
MT (Motor settling delay time)	5-47
MU (Make up mode)	5-48
MV (Moving)	5-48
NE (Numeric enable)	5-49
O1, O2, O3 and O4 (Set outputs 1, 2, 3 or 4)	5-49
O9, O10, O11 and O12 (Set outputs 9, 10, 11 or 12)	5-50
OE (On error handler)	5-50
OL (Set outputs 1 - 4 as a group)	5-51
OH (Set outputs 9 - 12 as a group)	5-51
OT (Set outputs 1- 4 and 9 - 12 as a group)	5-52
P (Position counter)	5-52
PC (Position capture at trip)	5-53
PG (Program mode)	5-53
PM (Position maintenance enable)	5-54
PN (Part number)	5-54
PR (Print specified data or text)	5-55
PS (Pause program execution)	5-55
PW (PWM configuration)	5-56
PY (Party mode enable)	5-57
QD (Queued)	5-58
R1, R2, R3 and R4 (User registers)	5-58
RC (Motor run current)	5-59
RS (Resume program execution)	5-59
RT (Return from subroutine)	5-60
S (Save to NVM)	5-60
S1, S2, S3, S4, S9, S10, S11, S12 (Setup I/O 1 - 4 & 9 - 12) ..	5-61
S5 (Set analog input)	5-63
S7 & S8 (Setup clock I/O points)	5-64
S13 (Setup capture input/trip output)	5-65
SC (Start calibration)	5-65
SF (Stall factor)	5-66
SL (Slew axis)	5-66
SM (Stall detect mode)	5-67
SN (Serial number)	5-67
SS (System speed)	5-68
ST (Stall flag)	5-68
SU (Execute program on power up)	5-69
TA (Trip on Hybrid status)	5-69
TC (Trip capture)	5-70
TD (Torque direction)	5-70
TE (Trip enable)	5-71
TI (Trip on input)	5-71

	TP (Trip on position).....	5-72
	TQ (Set torque)	5-72
	TR (Trip on relative position).....	5-73
	TS (Set torque speed).....	5-74
	TT (Trip on position).....	5-74
	UG (Upgrade firmware).....	5-75
	UV (Read user variables).....	5-75
	V (Read velocity).....	5-75
	VA (Create user variable).....	5-76
	VC (Velocity changing).....	5-76
	VI (Initial velocity)	5-77
	VM (Maximum velocity).....	5-77
	VR (Firmware version)	5-78
	WT (Warning temperature)	5-78
6	Supporting Software	6-1
6.1	IMS Terminal.....	6-1
6.1.2	Features.....	6-1
6.1.3	Installing IMS Terminal	6-2
6.1.4	Screen and menu overview	6-2
6.4.2	The menu bar structure and operation	6-3
6.4.3	Edit menu operation.....	6-3
6.1.5	Configuring IMS Terminal.....	6-5
6.1.6	Troubleshooting communications	6-7
6.1.7	Configuring function keys	6-8
6.1.8	Creating, downloading and uploading programs	6-10
6.1.9	Program troubleshooting using IMS Terminal .	6-12
6.1.10	Upgrading firmware	6-14
6.2	TCP/IP Configuration Utility.....	6-18
6.2.1	Installation.....	6-18
6.2.2	Screen overview	6-18
6.2.3	Configuration	6-19
6.2.4	SEM Port tab	6-20
7	Programming and application notes	7-1
7.1	Party mode communications	7-1
7.1.1	Response to Echo Mode	7-1
7.1.2	Using Check Sum	7-3
7.1.3	Immediate party mode sample codes.....	7-4
7.2	Programming the I/O.....	7-5
7.2.1	I/O availability per device type	7-5
7.2.2	Active states defined.....	7-6
7.2.3	Digital input functions.....	7-6
7.2.4	Digital output functions	7-9
7.2.5	Programmable I/O usage examples	7-10
7.2.6	Dedicated digital I/O usage.....	7-13
7.2.7	Analog input usage	7-15
7.3	Factors impacting motion commands.....	7-16
7.3.1	Motor steps	7-16
7.3.2	Microsteps: (MS)	7-16
7.3.3	Move Command	7-16
7.3.4	Closed loop control with an encoder.....	7-16
7.3.5	Linear movement.....	7-17
7.3.6	Calculating rotary movement.....	7-19
7.3.7	Programming with the optional encoder enabled	7-21
7.4	MForce PWM configuration.....	7-25
7.4.1	Description:.....	7-25

	7.4.2	PWM Mask <mask> Parameter.....	7-25
	7.4.3	Max PWM duty cycle (%) <period> parameter	7-26
	7.4.4	PWM frequency <sfreq> parameter.....	7-27
	7.4.5	PWM checksum <chksum> parameter	
		(boot write only)	7-28
	7.4.6	Boot writes remaining <boot_writes_remaining> ...	
		parameter (read only)	7-29
	7.4.7	Example PWM settings by motor	
		specifications	7-29
8		Sample programs	8-1
	8.1	Move on an input.....	8-1
	8.2	Change velocity during a move	8-2
	8.3	Binary mask.....	8-3
	8.4	Closed ILoop	8-5
	8.5	User input into variables.....	8-6
	8.6	Closed loop with homing	8-7
	8.7	Input trip	8-8
9		Error codes	9-1
	9.1	I/O errors	9-1
	9.2	Data errors	9-1
	9.3	Program errors	9-2
	9.4	Communications errors	9-2
	9.5	System errors	9-3
	9.6	Motion errors	9-3
	9.7	Hybrid errors.....	9-4

List of Figures

Figure 3.1	Recommended MCode program structure	3-4
Figure 5.1	Homing functions sequence of events	5-30
Figure 5.2	Limit modes of operation	5-41
Figure 6.1	IMS Terminal main screen	6-2
Figure 6.2	Function key setup dialog.....	6-8
Figure 7.1	Step/direction I/O type & configuration.....	7-13
Figure 7.2	Quadrature I/O configuration.....	7-14
Figure 7.3	CW/CCW I/O configuration	7-14
Figure 7.4	Trapezoidal move profile	7-17
Figure 7.5	Rotary examples	7-19
Figure 7.6	Encoder waveform	7-21
Figure 7.7	PWM mask bits	7-26
Figure 7.8	PWM frequency range.....	7-27

List of Tables

Table 7.1	Response to echo mode - party and check sum are zero (0)	7-2
Table 7.2	Response to echo mode - party is one (1) and check sum is zero (0)	7-3
Table 7.3	Response to echo mode - party is zero (0) and check sum is one (1)	7-3
Table 7.4:	Response to echo mode - party and check sum are one (1)	7-3
Table 7.5	Digital input functions	7-7
Table 7.6	Clock and high speed input functions	7-8
Table 7.7	Digital output functions	7-9
Table 7.8	Clock and high speed output functions	7-10
Table 7.8	PWM Mask Settings.....	7-26
Table 7.9	Typical PWM Mask Settings.....	7-26
Table 7.10	Maximum PWM frequency	7-27
Table 7.11	Initial PWM frequency	7-27
Table 7.12	Example PWM settings	7-29

1 Introduction

1.1 About this manual

This manual is devices utilizing the MCode programming language.

1.2 MCode versions

1.2.1 MCode

MCode is the programming and control language for products communicating over serial RS-422/485.

1.2.2 MCode/TCP

MCode/TCP is the MCode language adapted to communicate over Ethernet TCP/IP networks. The function and usage is identical with the exception that the commands related to RS-422/485 communication are disabled. MCode/TCP will connect to TCP or UDP port 503.

1.3 MCode device overview

The following product lines use MCode for configuration and programming:

- MDrive Motion Control products
- MForce Motion Control products
- MDrive Hybrid Motion Control products

Many of the MCode commands are device-specific based on available I/O, Hybrid Motion Technology and communications interface. In the command detail (Section 5), each command is listed with device compatibility. Ensure that the command will function with your device before using.

1.4 Documentation reference

The following user's manuals are available for the MCode devices:

- Product hardware manual, describes the technical data and installation of the product.
- Product software manual, describes the configuration and programming of the product.
- Quick Reference, describes the basic wiring, connection and use of this product. The quick reference is shipped in printed form with the product.

This documentation is also available for download from our web site at: <http://motion.schneider-electric.com>

1.4.1 Related documents

MODBUS/TCP The MODBUS/TCP Fieldbus manual describes the implementation of the MODBUS protocol for Ethernet equipped MDrive products. When connected to TCP port 502, the MDrive Ethernet will only respond to MODBUS commands.

EtherNet/IP The EtherNet/IP Fieldbus manual describes the implementation of the EtherNet/IP protocol for Ethernet equipped MDrive products.

1.5 Product software ^T

The following drivers and software may be downloaded from the web site at: http://www.schneider-electric-motion.us/downloads/software_interfaces.html

1.5.1 Communications converter drivers

If using the MD-CC40x-001 communications converter, drivers are required, these drivers are available for download from our web site at http://www.schneider-electric-motion.us/downloads/cable_drivers.html.

1.5.2 ASCII program editor and ANSI terminal emulator

Motion control products may be configured and programmed using any standard ANSI terminal emulator and ASCII text editor.

The recommended tool is the IMS Terminal integrated terminal and program editor. IMS Terminal features color-coded editor, multiple-function keys and is pre-configured to operate using the MDrive default settings

Installation and usages instructions are to be found in MCode software manual.

1.5.3 TCP/IP configuration utility

The TCP/IP configuration utility is a user interface for configuring the Ethernet equipped MDrive models in either EtherNet/IP MCode/TCP or MODBUS/TCP.

This GUI offers basic setup and test functionality and is required to change the MDrive's IP/SubNet address from the default 192.168.33.1/255.255.0.0.

IMS Terminal is then recommended for programming the MDrive in MCode/TCP mode.

2 Safety

2.1 Qualification of personnel

Only technicians who are familiar with and understand the contents of this manual and the other relevant documentation are authorized to work on and with this drive system. The technicians must be able to detect potential dangers that may be caused by setting parameters, changing parameter values and generally by the operation of mechanical, electrical and electronic equipment.

The technicians must have sufficient technical training, knowledge and experience to recognise and avoid dangers.

The technicians must be familiar with the relevant standards, regulations and safety regulations that must be observed when working on the drive system.

2.2 Intended Use

The drive systems described here are products for general use that conform to the state of the art in technology and are designed to prevent any dangers. However, drives and drive controllers that are not specifically designed for safety functions are not approved for applications where the functioning of the drive could endanger persons. The possibility of unexpected or unbraked movements can never be totally excluded without additional safety equipment.

For this reason personnel must never be in the danger zone of the drives unless additional suitable safety equipment prevents any personal danger. This applies to operation of the machine during production and also to all service and maintenance work on drives and the machine. The machine design must ensure personal safety. Suitable measures for prevention of property damage are also required.

In all cases the applicable safety regulations and the specified operating conditions, such as environmental conditions and specified technical data, must be observed.

The drive system must not be commissioned and operated until completion of installation in accordance with the EMC regulations and the specifications in this manual. To prevent personal injury and damage to property damaged drive systems must not be installed or operated.

Changes and modifications of the drive systems are not permitted and if made no warranty and liability will be accepted.

The drive system must be operated only with the specified wiring and approved accessories. In general, use only original accessories and spare parts.

The drive systems must not be operated in an environment subject to explosion hazard (ex area).

2.3 Hazard Categories

Safety notes and general information are indicated by hazard messages in the manual. In addition there are symbols and instructions affixed to the product that warn of possible hazards and help to operate the product safely.

Depending on the seriousness of the hazard, the messages are divided into three hazard categories.

DANGER indicates an imminently hazardous situation, which, if not avoided, will result in death or serious injury.

▲ WARNING

WARNING indicates a potentially hazardous situation, which, if not avoided, **can result** in death, serious injury, or equipment damage.

▲ CAUTION

CAUTION indicates a potentially hazardous situation, which, if not avoided, **can result** in injury or equipment damage.

CAUTION

CAUTION used without the safety alert symbol, is used to address practices not related to personal injury (e.g. **can result** in equipment damage).

2.4 General safety instructions

DANGER

UNINTENDED CONSEQUENCES OF EQUIPMENT OPERATION

When the system is started, the drives are usually out of the operator's view and cannot be visually monitored.

- Only start the system if there are no persons in the hazardous area

Failure to follow these instructions will result in death or serious injury.

DANGER

EXPOSED SIGNALS

Hazardous voltage levels may be present if using an open frame power supply to power the product.

Failure to follow these instructions will result in death or serious injury.

WARNING

LOSS OF CONTROL

- The designer of any control scheme must consider the potential failure modes of control paths and, for certain critical functions, provide a means to achieve a safe state during and after a path failure. Examples of critical control functions are emergency stop, overtravel stop, power outage and restart.
- Separate or redundant control paths must be provided for critical functions.
- System control paths may include communication links. Consideration must be given to the implication of unanticipated transmission delays or failures of the link.
- Observe all accident prevention regulations and local safety guidelines. 1)
- Each implementation of the product must be individually and thoroughly tested for proper operation before being placed into service.

Failure to follow these instructions can result in death or serious injury.

1) For USA: Additional information, refer to NEMA ICS 1.1 (latest edition), "Safety Guidelines for the Application, Installation, and Maintenance of Solid State Control" and to NEMA ICS 7.1 (latest edition), "Safety Standards for Construction and Guide for Selection, Installation and Operation of Adjustable-Speed Drive Systems".

▲ CAUTION**MOVEMENT ON POWER APPLICATION**

Hybrid Motion Technology's functionality requires that the rotor and stator of the motor be in precise alignment. To accomplish this, the product will perform an initial calibration move upon power up consisting of a 6 motor full step (10.8°) move in the clockwise direction, followed by a 3 motor full step (5.4°) move in the counter-clockwise direction.

- Only power the system if there are no persons in the hazardous area.

Failure to follow these instructions can result in injury or equipment damage.

CAUTION**HOT PLUGGING!**

Do not connect or disconnect power, logic, or communications while the device is in a powered state.

Remove DC power by powering down at the AC side of the DC power supply.

Failure to follow these instructions can result in equipment damage.

3 Introduction to MCode programming

This section will acquaint the user with basics of MCode programming and the simple 1 and 2 character mnemonics which make up the MCode programming language.

- Operational modes.
- Basic components of the MCode programming language.

3.1 Operational modes

There are two operational modes for the MCode compatible products: Immediate and Program.

- 1) **Immediate:** Commands are issued and executed directly to the controller by user input into the terminal window.
- 2) **Program:** Program Mode is used to input user programs into the motion controller.

3.2 Basic components of MCode software

There are five basic components of the MCode Programming Language, they are:

- 1) Instructions
- 2) Variables
- 3) Flags
- 4) Keywords
- 5) Math functions

3.2.1 Instructions

An instruction results in an action. There are four types of instructions:

Motion Motion instructions are those that result in the movement of a motor. The syntax for these commands is as follows: type the command followed by a space, and then the velocity or position data. For example:MA 2000 will move the motor to an absolute position of 2000.

I/O An I/O instruction results in the change of parameters or the state of an input or output. The syntax for these commands are as follows: type the command then an equal sign, then the data. Example: O2=0 will set output 2 to 0.

Program A program instruction allows program manipulation. The syntax of these vary due to the nature of the command. Some command examples would be: PG 100, which toggles the system into program mode starting at address 100; BR LP, I1=1, which will branch to a program labeled LP if input 1 is true.

System A system instruction is an instruction that can only be used in immediate mode to perform a system operation such as program execution (EX) or listing the contents of program memory (L). For example: EX 100 will execute a program located at address 100 of program memory space, or EX K1 will execute a program labeled K1.

3.2.2 Variables

A Variable is identified by a mnemonic and allows the user to define or manipulate data. These can also be used with the math functions to manipulate data. There are two classes of variables: factory-defined and user-defined. There are 192 user program labels and variables available. The syntax for each variable may differ.

Factory defined variables These variables are predefined at the factory. They cannot be deleted. When an FD (Factory Default) instruction is given, these variables will be reset to their factory default values. There are two types of factory defined variables:

- **Read/Writable:** These factory defined variables can have their value altered by the user to affect events inside or outside of a program. For example A (Acceleration variable) can be used to set the Acceleration, or P (Position variable) can be used to set the position counter.
- **Read Only:** These factory defined variables cannot be changed by the user. They contain data that can be viewed or used to affect events inside a program. For example, V (Velocity variable) registers the current velocity of the motor in steps per second.

User defined variables The VA instruction allows the user to create a 2 character name to a user defined variable (32 bit value).

The restrictions for this command are:

- 1) A variable cannot be named after an MCode Instruction, Variable or Flag.
- 2) The first character must be alpha, the second character may be alphanumeric.
- 3) A variable is limited to two characters.

With these the user can define a variable to store and retrieve data and perform math functions. When the FD (Factory Defaults) instruction is given, these variables will be deleted! There are two types of user defined variables:

- **Global variables:** global variables are variables that are defined outside of a program. The benefit to using a global variable is that no user program memory is required. For example, the user can define a variable called SP for speed by entering VA SP into the terminal. The user can then set that variable equal to the value of a read only variable V (velocity) by entering SP = V into the terminal.
- **Local variables:** this type of user defined variable is defined within a program and can only affect events within that program. It is stored in RAM. Note a local variable is not static, but is erased and declared again each time a program is executed.

3.2.3 Flags

Flags show the status of an event or condition. A flag will only have one of two possible states: either 1 or 0. Unlike variables, there are only factory defined flags.

Factory defined flags

Factory defined flags are predefined at the factory and cannot be deleted. When a FD (Factory Defaults) instruction is given, these flags will be returned to their factory default state. There are two types of factory defined flags:

- **Read/Writable:** This type of flag is user alterable. They are typically used to set a condition or mode of operation for device. For example EE = 1 would enable encoder operation, or EE = 0 would disable the encoder functions.
- **Read Only:** Read Only flags cannot be changed by the user. They only give the status of an event or condition. Typically this type of flag would be used in a program in conjunction with the BR (Branch Instruction) to generate an if/then event based upon a condition. For example the following line of code in a program BR SP, MV = 0 would cause a program to branch to a subroutine named "SP" when the MV, the read only moving flag, is false.

3.2.4 Keywords

Keywords are used in conjunction with the PR and IP instructions to indicate or control variables and flags. For instance, PR UV would print the state of all the user-defined variables to the screen. IP would restore all the factory variables from the NVM.

3.2.5 Math functions

Math functions are used to perform various arithmetic functions on numeric data stored in registers or variables. Supported functions are +, -, x, ÷, >, <, =, <=, >=, <>, AND, OR, XOR, NOT.

Example

AdditionK2†=P+R2
 SubtractionK3†=R1-P
 Multiplication A=A*2
 Division A=A/2

†User-defined variable used as an example.

3.3 Program structuring

Proper structuring of your MCode program will ensure your ability to work efficiently and will aid in trouble shooting your program. The figure below illustrates how your program can be blocked out to group the global system declarations, the main program body and the subroutines.

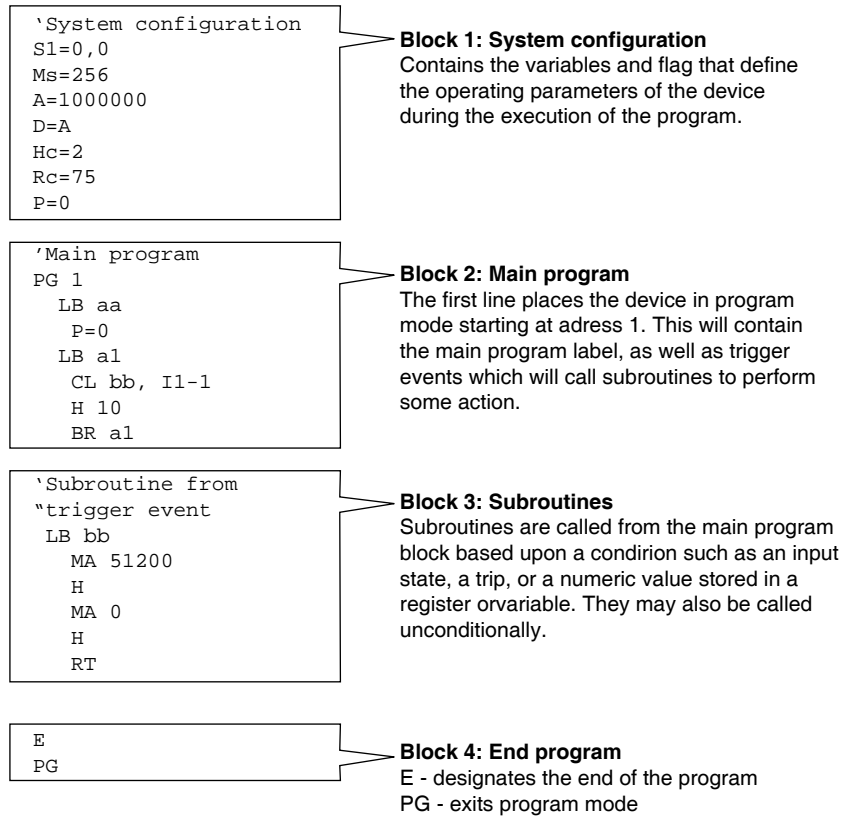

Figure 3.1 Recommended MCode program structure

3.3.1 Programming aids

IMS Terminal One of the most powerful tools available to you is the IMS Terminal software. IMS Terminal is an integrated Terminal and Program Text editor. The text editor will automatically color-code the Variables, Flags and Instructions that make up your program, as well as automatically indent program blocks for easy visual identification of your program elements.

The IMS Terminal also has several features that assist in program troubleshooting.

For more information on IMS Terminal see Section 6 Installing and Using IMS Terminal.

User Labels The MCode programming language allows for 192 user labels for your programs, subroutines, and user variables and flags. A label consists of 2 characters, the first of which must be a letter, the second may be alphanumeric. A label cannot use the same character combination as any of the mnemonics used in the MCode programming language.

For purpose of this manual we have used the following example labels because the beginning alpha character is not used in any instruction set mnemonic:

- Program label (G).....Example: G1, G8, Ga
- Subroutine label (K) Example: K7, K2, Ks
- User variable label (Q) Example: Q3, Q9, Qz

Example labeling

```

VA Q1          `Create user variable Q1

PG 100        `Enter Program mode
LB G1         `Label Program G1
CL K1, I2=1   `Call Subroutine K1 if Input 2 is HIGH
BR G1         `Unconditional Branch to G1

K1            `Declare Subroutine K1
    
```

Comments MCode allows for comments to be inserted in your program code. The comment character for the MCode language is the Apostrophe ('). The device will ignore the text string following the apostrophe. Please note that the maximum length of a single line of program code is 64 characters, this includes program text, spaces and comments.

Using comments will be of assistance in trouble shooting your program.

Programming reference Another powerful tool is this manual. Section 3 contains detailed explanations and usage examples of each mnemonic in the MCode Programming Language. In Section 8 there are a number of fully commented example programs that can be used to learn the basics of programming and using the various functions of your MCode compatible device.

3.4 Commonly used variables and instructions

3.4.1 Variables

MS (Microstep resolution)

MS (Microsteps Select) defines the resolution of the stepping motor.

- A motor rotates 1.8° per step or 200 steps per revolution.
- The MS selection divides the number of steps to yield a finer resolution.
- An MS value of 256 x 200 would yield 51200 microsteps per revolution. (Each Motor step will be divided into 256 Micro-steps.)
- The MS default is 256.
- To read the MS value, type PR MS and press enter
- To write the MS value, type MS=<number> and press enter
- As we continue you will see that all motion variables use this value.

P (Position)

P indicates the position in either steps or encoder counts depending upon the enable/disable state of encoder functions.

- P takes its reading from C1 (Counter 1) when encoder functions are disabled. The reading is taken from C2 (Counter 2) when encoder functions are enabled.
- To read the position, type PR P or PR C1/C2 then press enter
- To zero the position, type P=0 then press enter

VI (Initial velocity)

Initial velocity in steps per second. (step size is a function of the value of MS).

- To read the initial velocity, type PR VI then press enter
- To write to the Initial velocity, type VI=<number> then press enter
- The VI default is 1000

VM (Maximum velocity)

Maximum or final velocity in steps per second. (Step size is a function of the value of ms).

- To read the final velocity, type PR VM then press enter
- To write to the final velocity, type VM=<number> then press enter
- The default VM Value is 768000

A (Acceleration) Acceleration in steps per second². (Steps per second, per second.)

- The velocity of the motor will increase by the value of the acceleration rate every second until it reaches the programmed velocity in SL mode or it reaches VM.
- To read the acceleration, type PR A then press enter
- To write to the acceleration, type A=<number> then press enter
- The Acceleration Default value is 1000000

D (Deceleration) Deceleration in steps per second². (Steps per second, per second.)

- The velocity of the motor will decrease by the value of the deceleration rate every second until it reaches the programmed velocity in SL mode or it reaches VI.
- To read the deceleration, type PR D then press enter
- To write to the deceleration, type D=<number> then press enter
- The deceleration default value is 1000000

3.4.2 Motion instructions

Motion instructions are those that cause the motors to move or affect the movement of the motor. There are a few factors that must be considered when programming motion commands. Linear distances, number of revolutions, degrees of rotation and timed moves can be calculated and programmed from these factors.

- All motion is programmed either microsteps per second or (when the encoder is enabled) encoder counts (pulses) per second.
- All motion is directly affected by the motion command and the program variables.
- There are a number of factors impacting motion instructions. These are addressed in detail in Section 7: Application and programming notes.

MA (Move absolute) Move to an absolute position relative to a defined zero position.

For example, type the following commands followed by pressing enter:

```
P=0          `set the current position to 0 (zero)
MA 20000    `move 20000 steps from 0 in the plus direction
PR P        `the terminal screen will read 20000
MA 3000     `move 3000 steps from 0 in the plus direction
PR P        `the terminal screen will read 3000
```

Absolute moves are always relative to 0 (zero).

You may program moves in the minus direction by typing the minus sign (-) before the value.

MR (Move relative) Move the number of steps programmed relative to current position.

For example, type the following commands followed by pressing enter:

```
P=0      `set the current position to 0 (zero)
MR 20000 `move 20000 steps from the current position in
         `the plus direction
PR P     `the terminal screen will read 20000
MR 3000  `move 3000 steps from the current position in
         `the plus direction
PR P     `notice the position read is 23000 and not 3000
```

Relative moves are cumulative and are either added to or subtracted from the current position.

You may program moves in the minus direction by typing the minus sign (-) before the value.

SL (Slew axis) Move at a constant velocity.

```
SL 200000 `the motor moves at a constant velocity 200000
          `steps per second
```

- The slew command overrides the VM (maximum velocity) parameter.
- The value of the slew command may be changed “on the fly”.
- You may program moves in the minus direction by typing the minus sign (-) before the value.

H (Hold) An H (hold command) should typically follow any MA or MR commands in a program so that program execution is suspended until the motion is complete.

Below is a usage example.

```
PG 100    `enter program mode at address 100
LB M1     `label program M1
MR 20000  `set mode to relative, move relative 20000
steps
H         `hold until motion completes
MR -20000 `move relative -20000 steps
H         `hold until motion completes
E         `end program
PG        `exit program mode
```

A delay time value (1 to 65000 milliseconds) may be programmed with the hold command.

(Note: There are circumstances where you may not want to hold up program execution.)

3.4.3 I/O instructions

Not all I/O instructions apply to all MCode device models. See section 4: command details for device compatability.

<i>S<1-4> <9-12> (Set I/O Point)</i>	<p>This command configures the Type and Active state of I/O points 1-4.</p> <ul style="list-style-type: none"> ■ Using the PR command to read I/O parameters ■ Read I/O1 Setup – “PR S1” ■ Read I/O2 Setup – “PR S2” <p>Set IO 3 parameters – “S3=0,1” Sets IO3 as a General Purpose Input, Active High</p> <p>For example: To set I/O4 as a jog+ input, active low, sinking</p> <pre style="margin-left: 40px;">S4 =7, 0, 0</pre>
<i>I<1-4><9-12> (Read input state)</i>	<p>Used to read the state of an individual input.</p> <p>PR I1 will read the state of input 1 and display it to the terminal window.</p> <p>BR K5, I2=0 will branch to the program address labled K5 when Input 2 is LOW</p>
<i>IN (Read all inputs as decimal)</i>	<p>Used to read the decimal equivalent of the 8 bit binary number represented by all 8 inputs collectively. Note the Input 12 is the Most Significant Bit.</p> <p>PR IN will print the decimal value of the inputs.</p> <p>IN will only read inputs 1-4 on devices equipped with only the standard I/O Set!</p>
<i>IL (Read inputs 1-4 as decimal)</i>	<p>Used to read the decimal equivalent of the 4 bit binary number represented by inputs 1 - 4 collectively. Note the input 4 is the most significant bit.</p> <p>Pr il will print the decimal value of the standard input set.</p>
<i>IH (Read inputs 9-12 as decimal)</i>	<p>Used to read the decimal equivalent of the 4 bit binary number represented by inputs 9 - 12 collectively. Note the input 12 is the most significant bit.</p> <p>PR IH will print the decimal value of the enhanced input set.</p>
<i>O<1-4><9-12> (Set output state)</i>	<p>Used to set the state of an output.</p> <p>O2=1 will set Output 2 TRUE</p> <p>O<9-12> are applicable to the enhanced I/O models only!</p>

<i>OT (Set all outputs as BCD)</i>	Used to set the 8 bit binary equivalent of the decimal number represented by all 8 outputs collectively. Note the output 12 is the most significant bit. OT=214 will set the outputs to 11010110 OT will only set outputs 1-4 on devices equipped with only the standard I/O Set!
<i>OL (Set outputs 1-4 as BCD)</i>	Used to set the 4 bit binary equivalent of the decimal number represented by outputs 1 - 4 collectively. Note the output 4 is the most significant bit. OT=10 will set the standard outputs to 1010.
<i>OH (Set outputs 9-12 as BCD)</i>	Used to set the 4 bit binary equivalent of the decimal number represented by outputs 1 - 4 collectively. Note the output 12 is the most significant bit. Ot=13 will set the enhanced outputs to 1101.

3.4.4 System instructions

The following system instructions will be used frequently.

<i>CP (Clear program memory)</i>	The CP instruction is used to clear program memory space.
<i>FD (Restore factory defaults)</i>	The FD instruction is used to return the device to its factory default state.
<i><esc> (Stop motion and program)</i>	<esc> The ESCAPE key will stop the user program and stop the motor with no decel rate.
<i><CTRL+C > (Reboot)</i>	<CTRL+C> CTRL+C will reboot the unit. This includes reloading of the programs stored in nonvolatile memory into RAM and executing any programs residing at label SU (Start Up).

3.4.5 Program instructions

PG (Begin program mode) This instruction toggles the device into or out of program mode.

```
PG 200      `Switch to program mode at address 200
xxxxx      `Program starting at address 200
xxxxx      `  |
xxxxx      `  |
PG          `Switch out of program mode
```

LB (Label program, subroutine or branch process)

MCode also offers the user the convenience of naming programs, sub-routines and processes to ease in branching from one part of a program to another, or calling a subroutine.

These labels, once set, will act as pointers to locations in program memory space.

The LB, or label instruction, allows the user to assign a 2 character name to a program or branch process within a program or subroutine.

The restrictions for this command are:

- 1) A label cannot be named after an instruction, variable or flag.
- 2) The first character must be alpha, the second character may be alpha-numeric.
- 3) A label is limited to two characters.
- 4) A program labeled SU will run on power-up

Please Note: Any program labeled "SU" will execute on power-up.

```
PG 200      `Switch to program mode at address 200
LB k1       `Label command will name the program K1
xxxxx      `Program named by LB command xxxxx
xxxxx      `
PG          `Switch out of program mode
```

BR (Branch) Used to branch conditionally or unconditionally to a routine.

```
PG 200      `Switch to program mode at address 200
LB K1       `Label command will name the program
xxxxx
xxxxx      `Program named by LB command
xxxxx
BR K1       `Unconditional branch to Program Label K1
PG          `Switch out of program mode
```

E (End program) Designates the end of a program.

```
PG 200      `Switch to program mode at address 200
LB K1       `Label command will name the program
xxxxx
xxxxx      `Program named by LB command
xxxxx
BR K1       `Unconditional branch to Program Label K1
```

H (Hold program execution) Delays program execution in milliseconds.

```

E          `End Program
PG         `Switch out of program mode

PG 200     `Switch to program mode at address 200
LB K1      `Label command will name the program
xxxxx
xxxxx     `Program named by LB command
xxxxx
H 2000    `Hold 2 seconds before execution of program
BR K1     `Unconditional branch to Program Label K1
E         `End Program
PG        `Switch out of program mode

```

PR (Print) Outputs specified text and parameter values to a terminal or terminal software on a host PC.

```

PG 200     `Switch to program mode at address 200
LB K1      `Label command will name the program
xxxxx
xxxxx     `Program named by LB command
xxxxx
H 2000    `Hold 2 seconds before execution.
PR "Position =", P      `Print position
BR K1     `Uncond branch to Program Label K1
E         `End Program
PG        `Switch out of program mode

```

VA (Create user variable) Command used to define a user variable consisting of 2 alphanumeric characters.

```

PG 200     `Switch to program mode at address 200
VA N1      `Define user variable N1
LB K1      `Label command will name the
program
xxxxx
xxxxx     `Program named by LB command
xxxxx
H 2000    `Hold 2 seconds before execution
PR "Position =", P      `Print position
BR K1, N1<10 `Cond branch to K1 if N1 less than 10
E         `End Program
PG        `Switch out of program mode

```

4 Command summary



MCode supports multiple families of motion control devices. Not all instructions, variables and flags apply to all motion control products.

See the detailed descriptions for each command in Section 5 of this document for device compatibility

4.1 Setup instructions, variables and flags

Mnemonic	Function	Unit	Range	Syntax Example
AL	Retrieve All Parameters	–	–	PR AL
BD	Communications BAUD Rate	BAUD	48, 96, 19, 38, 11	BD=<baud>
CE	Control C Software Reset	–	–	CE=<0/1>
CK	Check Sum Enable	–	–	CK=<1/0>
CM	Clock Mode Enable	–	1/0	CM=<1/0>
CR	Clock Mode Ratio	–	–	CR=1
CW	Clock Mode Output Step Width	–	0 to 255	CW=100
DE	Enable/Disable Drive	–	1/0	DE=<1/0>
DG	Disable Global Response	–	1/0	DG=<1/0>
DN	Device Name	Character	a–z, A–Z, 0–9	DN=<char>
EM	Echo Mode 0 (def)=Full Duplex, 1=Half Duplex	Mode	<0 to 3>	EM=<mode>
FD	Restore Factory Defaults	–	–	FD
IP	Initial Parameters from NVM	–	–	IP
PY	Enable/Disable Party Mode	Mode	1/0	PY=<mode>
QD	Queued	–	1/0	QD=<1/0>
UG	Upgrade Firmware	Code	2956102	IMS Term. Upgrader
WT	Warning Temperature	Degrees C	0 to 84	WT=<0 – 84>

4.2 Misc instructions, variables and flags

Mnemonic	Function	Unit	Range	Syntax Example
AL	All Parameters, Used with PR (Print)	–	–	PR AL
BY	BSY Flag 1=Prog. Running	–	0/1	PR BY
CM	Clock Mode	–	0/1	CM=1
CR	Clock Mode Ratio	–	–	CR=1
CW	Clock Mode Output Step Width	–	0 to 255	CW=100
EF	Error Flag	–	0/1	PR EF
ER	Error Number Variable	Number	–	PR ER
ES	Escape	–	–	ES=0
FD	Return to Factory Defaults	–	–	FD
IF	Input Variable Pending Flag	–	–	PR IF
IT	Internal Temperature	Degrees Celsius	-55°C to 125°C	PR IT
IV	Input Into Variable	Number	–	IV <var>
PN	Part Number	–	–	PR "Position="
PR	Print Selected Data and/or Text	–	–	PR <data/text string>
R1	User Register 1	Number	Signed 32 bit	R1=<number>
R2	User Register 2	Number	Signed 32 bit	R2=<number>
R3	User Register 3	Number	Signed 32 bit	R3=<number>
R4	User Register 4	Number	Signed 32 bit	R4=<number>
SN	Serial Number	–	–	PR SN
VR	Firmware Version	Number	–	PR VR
UV	Read User Variables	–	–	PR UV

4.3 Motion instructions, variables and flags

Mnemonic	Function	Unit	Range	Syntax Example
(-)	Do Previously Set Mode to/at This Value	per mode		--<number>
A	Set Acceleration	Steps/Sec ²	1000000000	A=<accel>
D	Set Deceleration	Steps/Sec ²	1000000000	D=<decel>
HC	Set Hold Current	% (Percent)	0 to 100	HC=<percent>
HT	Set Hold Current Delay Time	milliseconds	0–65000	HT=<msec>
JE	Jog Enable Flag	–	0/1	JE<0/1>
LM	Limit Stop Mode	–	1–6	LM=<number>
MA	Set Mode and Move to Abs. Position	±Position	Signed 32 bit	MA <±pos>
MD	Motion Mode Setting	–	–	–
MR	Set Mode and Move to Relative Position	±Distance	Signed 32 bit	MR <±dist>
MS	Set Microstep Resolution	Microsteps/step	MSEL Table	MS=<param>
MT	Motor Settling Delay Time	milliseconds	0–65000	MT=<msec>
MV	Moving Flag	–	–	PR MV
NE	Numeric Enable	–	0/1	NE<0/1>
RC	Set Run Current	% (Percent)	1 to 100	RC=<percent>
SL	Set Mode and Slew Axis	Steps/sec	±5000000	SL <velocity>
V	Read Current Velocity	Steps/sec	±5000000	PR V
VC	Velocity Changing Flag	–	–	BR<addr>, VC
VI	Set Initial Velocity	Steps/sec	1–5000000	VI=<velocity>
VM	Set Maximum Velocity	Steps/sec	1–5000000	VM=<velocity>

4.4 Program instructions, variables and flags

Mnemonic	Function	Unit	Range	Syntax Example
BP	Break Point	–	–	BP <addr>, <mode>
BR	Branch (Conditional/Unconditional)	–	–	BR <addr>, <cond>
BY	Program Executing	–	–	PR BY
CL	Call Subroutine (Conditional/Unconditional)	–	–	CL <addr>, <cond>
CP	Clear Program	Address	1-767	CP <addr>
DC	Decrement Variable	–	–	DC <var/ureg>
E	End Program Execution	–	–	E
ES	Set Escape Mode	–	0 – 3	ES=<0–3>
EX	Execute Program at Address Using Selected Trace Mode	1 to 767		EX <addr>, <mode>
H	Hold Prog. Execution Blank/0=Motion stops	milliseconds	Blank(0) 1-65000	H=<msec>
IC	Increment Variable	–	–	IC <var>
L	List Program	Address	1-767	L <addr>
LB	Create a Program Address Label Name			
LK	Lock User Program		0/1	LK=<0/1>
OE	On Error Handler 0=Disabled	Address	0/1-767	OE <addr>
PG	Start Program Entry at Specified Address	–	Blank/1-767	PG <addr>
PS	Pause Program Execution	–	–	PS
RT	Return from Subroutine	–	–	RT
RS	Resume Paused Program	–	–	RS
S	Save to NVM	–	–	S
SU	Start Program on Power On	–	–	LB SU
VA	Create A User Variable Name			Mnemonic

4.5 I/O instructions, variables and flags

Mnemonic	Function	Unit	Range	Syntax Example
D1	Set Input 1 Digital Filtering	Milliseconds	0–255	D1=<time>
D2	Set Input 2 Digital Filtering	Milliseconds	0–255	D2=<time>
D3	Set Input 3 Digital Filtering	Milliseconds	0–255	D3=<time>
D4	Set Input 4 Digital Filtering	Milliseconds	0–255	D4=<time>
D5	Set Input 5 Digital Filtering	Milliseconds	0–255	D5=<time>
D9 - D12	Input Switch Debounce	Milliseconds	0–255	D1=0
FC	Filter Capture	–	–	FC=3
FM	Filter Motion	–	–	FC=3
I1 -I4	Read Input 1-4	–	0/1	PR Ix, BR Ix,<cond>
I5	Read Input 5 (Analog)	–	0–1024	PR I5, BR I5,<cond>
I6	Read Encoder Index Mark Low true	–	–	PR I6
I9 - I12	Read Input	–	–	PR I2
IL	Read Inputs 1–4 as One Value	data	0–15	PR IL
IH	Read Inputs 9 -12 as One Value	data	0–15	PR IH
IN	Read Inputs 1–4 and 9-12 as One Value	data	0–255	PR IN
IT	Internal Temperature	Degrees Celsius	-55°C to 125°C	PR IT
O1-O4	Set Output x to Logic State	–	0/1	Ox=<1/0>
O9-O12	Set Output x to Logic State	–	0/1	Ox=<1/0>
OL	Write Data to Outputs 1–4 as One Value	data	0–15	OL=<data>
OH	Write Data to Outputs 9–12 as One Value	data	0–15	OT=<data>
OT	Write Data to Outputs 1–4 and 9-12 as One Value	data	0–255	OT=<data>
S1-S4	Setup IO Points 1-4	Type, Active	Type Table, 0/1	Sx=<type>,<active>
S9-S12	Setup IO Points 9-12	Type, Active	Type Table, 0/1	Sx=<type>,<active>
S5	Set/Print I/O Point 5	–	9 = 0 to +5 V / 10 = 4 to 20 mA	S5=<type>
S7 - S8	Setup I/O Point Type/Active State	–	–	S7=34,0
S9 - S12	Setup I/O Point Type/Active State	–	–	S9=2,0
S13	Setup I/O Point Type/Active State	–	–	S13=60,0
TI	Trip on Input	–	–	TI <input>,<addr>
TE	Trip Enable	See Table	<1–4>	TE=<num>

4.6 Position related instructions, variables and flags

Mnemonic	Function	Unit	Range	Syntax Example
C1	Set Counter 1	Motor Counts	Signed 32 bit	C1=<counts>
HM	Home to Home Switch	Type	1 to 4	HM <type>
P	Set/Read Position	Motor/Encoder Counts	Signed 32 bit	P=<counts>
PC	Read Captured Position at Trip	Motor/Encoder Counts	Signed 32 bit	PR PC
TP	Trip on Position	Position	–	TP <pos>, <addr>
TE	Trip Enable	See Table	<0-3>	TE=<num>

4.7 Encoder related instructions, variables and flags

Mnemonic	Function	Unit	Range	Syntax Example
C2	Set Counter 2	Encoder Counts	Signed 32 bit	C2=<counts>
DB	Set Encoder Deadband	Encoder Counts	0-65000	DB=<counts>
EE	Enable/Disable Encoder Functions	–	1/0	EE=<1/0>
HI	Home to Encoder Index	Type	1 to 4	HI=<type>
I6	Read Encoder Index Mark	–	–	I6
PM	Position Maintenance Enable Flag		0/1	PM=<0/1>
SF	Set Stall Factor	Encoder Counts	0-65000	SF=<counts>
SM	Set Stall Mode	0=Stop Motor/1=Don't Stop	1/0	SM=<mode>
ST	Stall Flag	–	0/1	PR ST

4.8 Hybrid specific instructions, variables and flags

Mnemonic	Function	Unit	Range	Syntax Example
AF	Read Hybrid Status	—	128 bit binary	PR AF BR <address>, AF=x CL <address>, AF=x
AS	Set Hybrid mode	—	0 = Off 1 = Fixed current (RC, HC) 2 = Variable current (RC max) (default) 3 = Torque	AS=2
CA	Set calibration mode	—	0 = Hard Stop Tolerant (fixed default) Second Parameter: Torque compensation 0 = Off (default) 1 = On	CA=0,0
CB	Set control bounds	—	0 = 1.1 Full step (torque) 1 = 1.3 Full step (default) 2 = 1.5 Full step 3 = 1.7 Full step (speed)	CB=2
CC	Set calibration current	%	1 to 100 (100 default)	CC=25
CF	Clear locked rotor fault	—	—	CF
CT	Set calibration time	mS	2 to 65535 (200 default)	CT=2000
EL	Remote encoder line count	Lines	—	EL=512
LD	Set rotor lead limit	step	0 to 2147483647 (102400 default)	LD=256000
LL	Read position lead/lag limit	steps	-2147483647 to +2147483647	PR LL BR <address>, LL=x CL <address>, LL=x
LG	Set rotor lag	step	0 to 2147483647 (102400 default)	LG=256000
LR	Locked rotor flag	—	0/1	
LT	Set locked rotor timeout	mS	2 to 65535 (2000 default)	LT=1000
MF	Set make-up frequency	Hz	306 to 5000000 (768000 default)	MF=51200

MU	Set make-up mode	—	0 = Off (default) 1 = Use MF (make-up freq) 2 = Use SS (system speed) Clear parameter (not saved)	MU=1,1
SC	Start calibration/ configuration test	—	1 = Use LL 2 = Clear LL	SC=1
SS	Set system speed	Steps/ sec	0 = Calibration 1 - Configuration test	SS=50000
TA	Trip on Hybrid status	—	38,910 — 5,000,000	TA=4,<address,label>
TD	Set torque direction	—	1 = Calibration done 2 = Hybrid active 4 = Locked rotor 8 = Lag limit 16 = Lead limit	TD=1
TQ	Set torque percent	%	0 = Minus 1 = Plus (default)	TQ=50
TS	Set torque mode speed	Steps/ sec	1 to 100 (25 default)	TS=50000

4.9 Math functions

Symbol	Function
+	Add Two Variables and/or Flags
-	Subtract Two Variables and/or Flags
*	Multiply Two Variables and/or Flags
/	Divide Two Variables and/or Flags
<>	Not Equal
=	Equal
<	Less Than
<=	Less Than and/or Equal
>	Greater Than
>=	Greater Than and/or Equal
&	AND (Bitwise)
	OR (Bitwise)
^	XOR (Bitwise)
!	NOT (Bitwise)

5 MCode command details

A (Acceleration)

Compatible with Motion Control products:
 MDrive
 MDrive (Plus² expanded features)
 MDrive (Ethernet)
 MDrive Hybrid
 MDrive Hybrid (Ethernet)
 MForce
 MForce (Plus² expanded features)

Mnemonic	A
Function	Set acceleration
Type	Variable
Description	The A Variable sets the acceleration rate when changing velocity in steps per second ² . If the A was set at 76800 per second ² the motor would accelerate at a rate of 76800 counts per second, every second. If the maximum velocity was set at 768000 microsteps per second it would take 10 seconds to reach maximum speed if VI=0.
Syntax	A=<mode>
Units	Steps/Sec2 (EE=0)/Counts/Sec2 (EE=1)
Range	91 to 1525878997 (Steps), 91 to 61035160 (Encoder Counts)
Default	Default: 1000000(EE=0), 40000 (EE=1)
Usage	Program/Immediate, Read/Write
Code Example	A=20000 `Set Accel to 20000 steps/sec2 A=Q1 `Set Accel to user var Q1
Related	D

AL (Retrieve all parameters)

Compatible with Motion Control products:
 MDrive
 MDrive (Plus² expanded features)
 MDrive (Ethernet)
 MDrive Hybrid
 MDrive Hybrid (Ethernet)
 MForce
 MForce (Plus² expanded features)

Mnemonic	AL
Function	Retrieve all parameters
Type	Variable
Description	The AL variable is used with the PR (PRINT) instruction to print the value/state of all variables and flags to the terminal program.
Syntax	PR AL
Usage	Immediate, Read
Code Example	PR AL

AF (Hybrid flags)

Compatible with Motion Control products:
MDrive Hybrid
MDrive Hybrid (Ethernet)

Mnemonic	AF
Function	Read Hybrid status
Type	Read-only status flag
Description	The AF flag will print the status of the Hybrid logic.
Syntax	PR AF BR <address/label>, AF=<condition> CL <address/label>, AF=<condition>
Units	—
Range	128-bit binary
Conditions	1 Lead limit reached 2 Lag limit reached 4 Maximum lead/lag limit reached 8 Locked rotor 16 Hybrid mode is active 32 Hardware fault condition exists 64 At zero 128 Calibration is complete 256 Calibration fault
Notes	If multiple conditions exist the result is additive. i.e. At zero (64) and Calibration complete (128) AF=192
Usage	Program/Immediate, Read only
Code Example	PR AF 'print AF to the terminal BR XY, AF=128 'branch to XY when calibration 'complete
Related	AS, TA

AS (Hybrid mode)

Compatible with Motion Control products:
MDrive Hybrid
MDrive Hybrid (Ethernet)

Mnemonic	AS								
Function	Set Hybrid operational mode								
Type	Variable								
Description	The AS variable will set the operating mode for the Hybrid motion control device to one of four modes, which are detailed below. These modes will determine the active state of the Hybrid circuitry and the behavior characteristics of the MDrive Hybrid based upon motor current or motor torque.								
Syntax	AS=<mode>								
Units	—								
Range	0-3								
Modes	<table border="0"> <tr> <td style="vertical-align: top;">0</td> <td>Hybrid circuitry off.</td> </tr> <tr> <td style="vertical-align: top;">1</td> <td>Fixed current mode, motor current will be as specified by the run current (RC) and hold current (HC) variables at the speed specified by the system speed variable (SS).</td> </tr> <tr> <td style="vertical-align: top;">2</td> <td>Variable current mode, motor current will vary as needed to move/position the load with a maximum current level established by the run current (RC) variable..</td> </tr> <tr> <td style="vertical-align: top;">3</td> <td>Torque mode, motor torque and speed will vary as needed to move/position the load at the maximum torque specified by the set torque percent variable (TQ) at the maximum speed as specified by the set torque speed variable (TS).</td> </tr> </table>	0	Hybrid circuitry off.	1	Fixed current mode, motor current will be as specified by the run current (RC) and hold current (HC) variables at the speed specified by the system speed variable (SS).	2	Variable current mode, motor current will vary as needed to move/position the load with a maximum current level established by the run current (RC) variable..	3	Torque mode, motor torque and speed will vary as needed to move/position the load at the maximum torque specified by the set torque percent variable (TQ) at the maximum speed as specified by the set torque speed variable (TS).
0	Hybrid circuitry off.								
1	Fixed current mode, motor current will be as specified by the run current (RC) and hold current (HC) variables at the speed specified by the system speed variable (SS).								
2	Variable current mode, motor current will vary as needed to move/position the load with a maximum current level established by the run current (RC) variable..								
3	Torque mode, motor torque and speed will vary as needed to move/position the load at the maximum torque specified by the set torque percent variable (TQ) at the maximum speed as specified by the set torque speed variable (TS).								
Default	2 (variable current mode)								
Usage	Program/Immediate, Read/Write								
Code Example	AS=1 `set hybrid mode to fixed current`								
Related	RC, HC, HT, TD, TQ, TS								

AT (Reserved)

Mnemonic	AT
Function	Reserved for internal use
Description	Reserved for internal use, will return an error if used. Do not use as a user variable, flag or program label.

BD (Communications BAUD rate)

Compatible with Motion Control products:
 MDrive
 MDrive (Plus² expanded features)
 MDrive Hybrid
 MForce
 MForce (Plus² expanded features)

Mnemonic	BD										
Function	Set communications BAUD rate										
Type	Variable										
Description	<p>This variable sets the baud rate for serial communications with the MCode device. It sets the rate for the RS-422/485 interface. The baud rate is set by indicating the first two digits of the desired rate as shown in the range section below.</p> <p>In order for the new BAUD rate to take effect, the user must issue the S (SAVE) instruction and then reset the device. When the MCode device is reset, it will communicate at the new BAUD rate.</p>										
Syntax	BD=<mode>										
Units	Bits/second										
Range	48, 96, 19, 38, 11										
Modes	<table border="1"> <tr> <td>48</td> <td>4800 bps</td> </tr> <tr> <td>96</td> <td>9600 bps (default)</td> </tr> <tr> <td>19</td> <td>19200 bps</td> </tr> <tr> <td>38</td> <td>38400 bps</td> </tr> <tr> <td>11</td> <td>115200 bps - Not recommended for party mode communications configurations.</td> </tr> </table>	48	4800 bps	96	9600 bps (default)	19	19200 bps	38	38400 bps	11	115200 bps - Not recommended for party mode communications configurations.
48	4800 bps										
96	9600 bps (default)										
19	19200 bps										
38	38400 bps										
11	115200 bps - Not recommended for party mode communications configurations.										
Default	96 (9600 bps)										
Usage	Program/Immediate, Read/Write										
Code Example	<pre>BD=19 `set BAUD rate to 19200 bps S `save to NVM</pre>										
Notes	<p>If you change the Baud Rate in the MCode device it must be matched in IMS Terminal.</p> <p>A delay time between the command requests to the device must be considered to allow it time to interpret a command and answer the host before a subsequent command can be sent. The time between requests is dependent on the command and the corresponding response from the device.</p>										
Related	CK										

BP (Break point)

Compatible with Motion Control products:
 MDrive
 MDrive (Plus² expanded features)
 MDrive (Ethernet)
 MDrive Hybrid
 MDrive Hybrid (Ethernet)
 MForce
 MForce (Plus² expanded features)

Mnemonic	BP
Function	Set break point/execution mode
Type	Instruction
Description	<p>The BP, or Break Point Instruction allows the user to set break points within an MCode program to help in debugging the program.</p> <p>To use the BP instruction the program must be executed in either trace or single-step mode. The program will then run normally the number of times specified by the count, then go into single-step mode at the address or label specified by BP. Press the spacebar to step through the program if in single step mode.</p> <p>To disable the break point, set BP=0.</p>
Syntax	BP <address/label>,<count>
Usage	Program/Immediate
Code Example	<pre>BP X1, 3 `Break at label X1 after 3 cycles EX P1, 1 `Execute P1 in trace mode or EX P1,2 `Execute P1 in single step mode</pre>
Related	EX

BR (Program branch)

Compatible with Motion Control products:
 MDrive
 MDrive (Plus² expanded features)
 MDrive (Ethernet)
 MDrive Hybrid
 MDrive Hybrid (Ethernet)
 MForce
 MForce (Plus² expanded features)

Mnemonic	BR
Function	Conditional or unconditional program branch.
Type	Instruction
Description	<p>The branch instruction can be used to perform a conditional or unconditional branch to a routine in a MCode device program. It can also be used to perform loops and IF THEN logic within a program.</p> <p>There are two parameters to a branch instruction. These are used to perform two types of branches:</p> <p>Conditional Branch</p> <p>This type of branch first specifies an address or user label where program execution should continue if the second parameter, the condition, is true. The condition parameter may include flags as well as logical functions that are to be evaluated. Only one condition may exist.</p> <p>Unconditional Branch</p> <p>In this type of branch the second parameter is not specified, then the execution will continue at the label or address specified by the first parameter.</p>
Syntax	BR <address/label>,<condition>
Usage	Program
Code Example	<pre>BR 256, I2=1 'Cond. branch to address 256 'if input 1 = ACTIVE BR G1 'Unconditional branch to 'program label G1 BR G2, Q4<10 'Cond branch to program G2 if 'user var Q4 is less than 10</pre>
Related	EX

BY (Program executing)

Compatible with Motion Control products:
 MDrive
 MDrive (Plus² expanded features)
 MDrive (Ethernet)
 MDrive Hybrid
 MDrive Hybrid (Ethernet)
 MForce
 MForce (Plus² expanded features)

Mnemonic	BY
Function	Busy (program executing)
Type	Status flag
Description	The BY flag will indicate the status of program execution,
Syntax	PR BY
Response	0 - No programs running, 1 - program executing
Default	0
Usage	Immediate, Read only
Code Example	PR BY
Related	PR

C1 (Counter 1)

Compatible with Motion Control products:
 MDrive
 MDrive (Plus² expanded features)
 MDrive (Ethernet)
 MDrive Hybrid
 MDrive Hybrid (Ethernet)
 MForce
 MForce (Plus² expanded features)

Mnemonic	C1
Function	Counter 1 (position counter)
Type	Variable
Description	This variable contains the count of the clock pulses generated by the MCode compatible device. Counter 1 may be preset if necessary
Syntax	C1=<steps>
Units	Motor steps
Range	-2147483648 to +2147483647
Default	0
Usage	Program/Immediate, Read/Write
Code Example	<pre>C1=20000 `Set counter 1 to 20000 motor steps PR C1 `Print the value of C1 to the terminal screen CL K5,C1>2100000 `Call subroutine K5 if C1>2100000</pre>
Related	C2, P

C2 (Counter 2)

Compatible with Motion Control products:
 MDrive
 MDrive (Plus² expanded features)
 MDrive (Ethernet)
 MDrive Hybrid
 MDrive Hybrid (Ethernet)
 MForce
 MForce (Plus² expanded features)

Mnemonic	C2
Function	Counter 2 (encoder counter)
Type	Variable
Description	This variable contains the encoder edge count received by the MCode compatible device. Counter 1 may be preset if necessary
Syntax	C2=<counts>
Units	Encoder counts
Range	-2147483648 to +2147483647
Default	0
Usage	Program/Immediate, Read/Write
Code Example	<pre>C2=512 `Set counter 2 to 512 counts PR C2 `Print the value of C2 to the terminal screen CL K5,C2>2100000 `Call subroutine K5 if C2>2100000</pre>
Related	C1, P

CA (Calibration mode - HW ver 1.8+)

Compatible with Motion Control products:
 MDrive Hybrid
 MDrive Hybrid (Ethernet)

ASI Firmware > 4.0.06
 HW version 1.8+

▲ CAUTION

MOVEMENT ON POWER APPLICATION

Hybrid Motion Technology's functionality requires that the rotor and stator of the motor be in precise alignment. To accomplish this, the product will perform an initial calibration move upon power up consisting of a 6 motor full step (10.8°) move in the clockwise direction, followed by a 3 motor full step (5.4°) move in the counter-clockwise direction.

- Only power the system if there are no persons in the hazardous area.

Failure to follow these instructions can result in injury or equipment damage.

Mnemonic	CA				
Function	Set calibration mode				
Type	Variable				
Description	<p>Hybrid logic requires a calibration to set the initial relationship between the rotor and stator. A calibration is performed on power up to bring the rotor into physical alignment with the stator.</p> <p>During calibration, the motor and position lag / lead logic is cleared, and any incoming steps are ignored.</p> <p>Calibration occurs automatically these conditions:</p> <ul style="list-style-type: none"> • Power on • Reset • Hybrid functionality enabled • Bridge is re-enabled after being disabled • MSEL is changed. 				
Syntax	CA=<0>,<method>				
Units	—				
Range	0				
Modes	0 Hard Stop Tolerant (HST) See detailed description				
Methods	<table border="0"> <tr> <td style="padding-right: 10px;">0</td> <td>Torque compensation off</td> </tr> <tr> <td style="padding-right: 10px;">1</td> <td>Torque compensation on (not typically used for SSM mode).</td> </tr> </table>	0	Torque compensation off	1	Torque compensation on (not typically used for SSM mode).
0	Torque compensation off				
1	Torque compensation on (not typically used for SSM mode).				
Default	0 (HST mode)				
Usage	Program/Immediate, Read/Write				
Code Example	CA=0,1 `set torque compensation				
Notes	For MDrive Hybrid HW versions earlier than 1.8, please contact factory for support.				
Related	CC, CT, SC				

Detailed HST description

The purpose of calibration is to bring the rotor and stator into alignment which allows operation of the Hybrid Motion logic. The Hard Stop Tolerant (HST) calibration technique seeks to ensure proper alignment when

the rotor is mechanically prohibited from movement by a hard stop or excessive stick/slip.

HST tests for freedom of movement by attempting a 6 full step (10.8 deg) move in the CW direction followed by a 3 full step (5.4 deg) move in the CCW direction. The sequence proceeds as follows.

Pause for CT(Calibration Time) allowing system to settle.

- Perform 6 full step CW move.
- Wait for CT.
- Perform 3 full step CCW move.
- Pause for CT allowing rotor to settle
- Set Calibration complete flag.

If motion is blocked the following occurs:

- If the 1st move can not complete it is abandoned.
- If the 2nd move can not complete it is abandoned then the sequence will be restarted one time.
- If neither move can be completed after 2 times through the sequence an error 109 will be generated, the calibration complete flag will set, and the bridges will be disabled (a locked rotor response).
- To correct, ensure that the motor shaft is free to move in both directions. Torque compensation mode may be used for high inertia loads. Calibration current may be increased as well.

Calibration time and distance required when the motor is free to move in both directions.

- The time required typically is 3.12 seconds when CT is 250 mS. This value of CT gives the best compromise between time and proper calibration.
- Motor position will be advanced 3 full steps CW from initial position after calibration is complete. Motor position can be confirmed using the encoder counter C2. The step counter C1 does not count calibration steps

Calibration time and distance when motor is blocked.

- The time will vary significantly based on where in the motion and which motion is blocked. When the motor can not move at all in either direction the failure will typically indicate in 10 seconds.
- The motor position will also vary significantly based on which motion is effected and where within the motion.
- The motor position can be determined using the encoder counter C2. The step counter C1 does not count calibration steps.

The following indicate when calibration is complete.

- On power up, calibration is complete when the sign on message is sent.
- The flag register AF can be polled for the Calibration Complete flag.
- The trip on flag capability (TA to define, TE to enable) can be used also.
- The flags are useful after a manually initiated calibration.

For mechanical systems with a large amount of prevailing torque a secondary calibration step is available, Torque Compensation (CA=0,1).

- Th process measures and compensates for the prevailing torque.
- This typically adds 50 mS to the total calibration time and 1 encoder edge of movement

CB (Control bounds)

Compatible with Motion Control products:
MDrive Hybrid
MDrive Hybrid (Ethernet)

Mnemonic	CB								
Function	Set control bounds								
Type	Variable								
Description	There are four limits, or control bounds that can be selected. They are 1.1, 1.3, 1.5 and 1.7 full motor steps. Bounds of 1.1 will produce greater torque performance, though maximum speed will be reduced. Bounds of 1.7 will produce greater speed performance, though transient response is decreased. Best overall torque-speed performance is achieved with bounds set at 1.3 or 1.5.								
Syntax	CB=<bounds>								
Units	full motor step								
Range	0 — 3								
Bounds	<table border="0"> <tr> <td>0</td> <td>1.1 full motor steps — best torque performance</td> </tr> <tr> <td>1</td> <td>1.3 full motor steps — best overall performance</td> </tr> <tr> <td>2</td> <td>1.5 full motor steps</td> </tr> <tr> <td>3</td> <td>1.7 full motor steps — best speed performance</td> </tr> </table>	0	1.1 full motor steps — best torque performance	1	1.3 full motor steps — best overall performance	2	1.5 full motor steps	3	1.7 full motor steps — best speed performance
0	1.1 full motor steps — best torque performance								
1	1.3 full motor steps — best overall performance								
2	1.5 full motor steps								
3	1.7 full motor steps — best speed performance								
Default	1 (1.3 full motor steps)								
Usage	Program/Immediate, Read/Write								
Code Example	CB=2 `set control bounds to 1.5 steps`								
Notes	For torque mode operation the bounds are preset.								
Related									

CC (Calibration current)

Compatible with Motion Control products:
MDrive Hybrid
MDrive Hybrid (Ethernet)

Mnemonic	CC
Function	Set calibration current
Type	Variable
Description	
Syntax	CC=<percent>
Units	Percent
Range	1 — 100
Default	100%
Usage	Program/Immediate, Read/Write
Code Example	CC=25 `set calibration current to 25%`
Related	CA, CT

CE (Software reset enable)

Compatible with Motion Control products:
 MDrive
 MDrive (Plus² expanded features)
 MDrive (Ethernet)
 MDrive Hybrid
 MDrive Hybrid (Ethernet)
 MForce
 MForce (Plus² expanded features)

Mnemonic	CE						
Function	Software reset enable (CTRL+C)						
Type	Setup flag						
Description	This setup flag will configure the device to respond or not respond to a CTRL+C software reset.						
Syntax	CE=<mode>						
Range	0 - 2						
Modes	<table border="0"> <tr> <td>0</td> <td>Disables CTRL+C response</td> </tr> <tr> <td>1</td> <td>Enables CTRL+C response (default)</td> </tr> <tr> <td>2</td> <td>Is addressable in party mode (PY=1), CTRL+C will respond the same as CE=1 when not in party mode.</td> </tr> </table>	0	Disables CTRL+C response	1	Enables CTRL+C response (default)	2	Is addressable in party mode (PY=1), CTRL+C will respond the same as CE=1 when not in party mode.
0	Disables CTRL+C response						
1	Enables CTRL+C response (default)						
2	Is addressable in party mode (PY=1), CTRL+C will respond the same as CE=1 when not in party mode.						
Default	1						
Usage	Program,/Immediate, Read/Write						
Code Example	CE=0 `disable CTRL+C response						

CF (Clear locked rotor fault)

Compatible with Motion Control products:
 MDrive Hybrid
 MDrive Hybrid (Ethernet)

Mnemonic	CF
Function	Clear locked rotor fault
Type	Instruction
Description	The CF instruction will clear a locked rotor fault, re-enable the output bridge and initiate a timed calibration (for version 1.5 logic)..
Syntax	CF
Usage	Program/Immediate, Read/Write
Code Example	CF `clear locked rotor fault
Related	CA, CT, LR

CK (Checksum enable)

Compatible with Motion Control products:
 MDrive
 MDrive (Plus² expanded features)
 MDrive Hybrid
 MForce
 MForce (Plus² expanded features)

Mnemonic	CK						
Function	Check sum enable						
Type	Flag						
Description	This setup flag will configure the device operate in check sum mode where a check sum is required following the command.						
Syntax	CK=<mode>						
Range	0 - 2						
Modes	<table border="0"> <tr> <td>0</td> <td>Checksum mode disabled (default)</td> </tr> <tr> <td>1</td> <td>Puts the device into Check Sum Mode. When enabled, all communications with the device require a Check Sum to follow the commands. The Check Sum is the 2's complement of the 7 bit sum of the ASCII value of all the characters in the command "OR"ed with 128 (hex = 0x80). The command will be acknowledged with a NAK (0x15) if the Check Sum is incorrect or an ACK (0x06) when the command is correctly processed (no error).</td> </tr> <tr> <td>2</td> <td>CK=2 will enable check sum mode, however NAK only sent for bad check sum. "ACK" is not echoed if a program is running. Only a NAK is echoed if an error occurs. In immediate mode both ACK or NAK characters are echoed.</td> </tr> </table>	0	Checksum mode disabled (default)	1	Puts the device into Check Sum Mode. When enabled, all communications with the device require a Check Sum to follow the commands. The Check Sum is the 2's complement of the 7 bit sum of the ASCII value of all the characters in the command "OR"ed with 128 (hex = 0x80). The command will be acknowledged with a NAK (0x15) if the Check Sum is incorrect or an ACK (0x06) when the command is correctly processed (no error).	2	CK=2 will enable check sum mode, however NAK only sent for bad check sum. "ACK" is not echoed if a program is running. Only a NAK is echoed if an error occurs. In immediate mode both ACK or NAK characters are echoed.
0	Checksum mode disabled (default)						
1	Puts the device into Check Sum Mode. When enabled, all communications with the device require a Check Sum to follow the commands. The Check Sum is the 2's complement of the 7 bit sum of the ASCII value of all the characters in the command "OR"ed with 128 (hex = 0x80). The command will be acknowledged with a NAK (0x15) if the Check Sum is incorrect or an ACK (0x06) when the command is correctly processed (no error).						
2	CK=2 will enable check sum mode, however NAK only sent for bad check sum. "ACK" is not echoed if a program is running. Only a NAK is echoed if an error occurs. In immediate mode both ACK or NAK characters are echoed.						
Default	0						
Usage	Program,/Immediate, Read/Write						
Code Example	<pre>MR 1 `MCode Command 77 82 32 49 `Decimal Value 4D 52 20 31 `Hex 77 + 82 + 32 + 49 = 240 `Add decimal values together 1111 0000 240 `Change 240 decimal to binary 0000 1111 `1's complement 0001 0000 `Add 1 (results in the 2's 1000 0000 `complement) 1001 0000 144 `OR result with 128 `result Check Sum value in `decimal</pre>						
Notes	To Send the checksum, in IMS terminal use ALT+ Checksum (In the example ALT+0144) The Response will be 06						
Related	BD						

CL (Call subroutine)

Compatible with Motion Control products:
 MDrive
 MDrive (Plus² expanded features)
 MDrive (Ethernet)
 MDrive Hybrid
 MDrive Hybrid (Ethernet)
 MForce
 MForce (Plus² expanded features)

Mnemonic	CL
Function	Call subroutine
Type	Instruction
Description	<p>This function can be used to invoke a subroutine within a program. This allows the user to segment code and call a subroutine from a number of places rather than repeating code within a program.</p> <p>There are two parameters to the CL instruction. The first specifies the program address or label of the subroutine to be invoked if the second parameter, the condition, is true. If the second parameter is not specified, the subroutine specified by the first parameter is always invoked. The condition parameter can include flags as well as logical functions that are to be evaluated. There can only be one condition.</p> <p>The subroutine should end with a RT (Return) instruction. The RT instruction will cause program execution to return to the line following the CL instruction.</p>
Syntax	CL=<address/label>,<condition>
Usage	Program,/Immediate, Read/Write
Code Example	<pre>CL 256, I5<512 `Call Sub at 256, analog in < than 512 CL K5 `Unconditional call to subroutine label K5 CL K8, I4=0 `Call sub k8 if input 4 is INACTIVE</pre>
Notes	The called subroutine should end with a return command (RT)
Related	RT

CM (Clock mode enable)

Compatible with Motion Control products:
 MDrive (Plus² expanded features)
 MForce (Plus² expanded features)

 WARNING
<p>If CM=1 (Following Mode Enabled) Limit functions will not operate.</p> <p>To overcome this limits must either be handled by the controlling electronics or the MCode compatible device can be programmed to Trip On Input (See TI)</p> <p>Failure to follow these instructions can result in equipment damage.</p>

Mnemonic	CM
Function	Clock mode enable
Type	Flag
Description	<p>This flag (when CM=1) will enable the clock I/O 7 and 8. If S7 and S8 are set as Input type, the device will be in follower mode. If S7 and S8 are set as output types, signal will be motor step counts out.</p>
Syntax	CM=<0/1>
Range	0 - 1
Default	0
Usage	Program/Immediate, Read/Write
Code Example	CM=1 `Enable Clock Mode
Related	S7, S8, CR, CW, FM

CP (Clear program)

Compatible with Motion Control products:
 MDrive
 MDrive (Plus² expanded features)
 MDrive (Ethernet)
 MDrive Hybrid
 MDrive Hybrid (Ethernet)
 MForce
 MForce (Plus² expanded features)

Mnemonic	CP
Function	Clear program
Type	Instruction
Description	This instruction will clear the program space in the NVM as specified by the instruction parameter. Programs are stored directly to the NVM and executed from there. Will clear program addresses only. Will not clear globally declared user variable or flags. FD will clear program memory as well.
Syntax	CP <address/label>
Usage	Immediate
Code Example	<pre>CP 256 `Clear prog. space beginning at addr. 256 CP G3 `Clear program space beginning at label G3 CP `Clear all of program space</pre>
Related	FD, IP

CR (Clock ratio)

Compatible with Motion Control products:
 MDrive (Plus² expanded features)
 MForce (Plus² expanded features)

Mnemonic	CR
Function	Clock ratio
Type	Variable
Description	Clock Ratio value for electronic gearing. The value selected will set the ratio from the clock input on I/O 7 (Step Clock) and I/O 8 (Direction) to the drive output. A Clock Ratio set to 0.50 will cause the frequency pulses sent to the driver section of the device to be 0.50 of the frequency input to the device, this would cause the device to "follow" at half the velocity of the primary axis.
Syntax	CR <ratio>
Range	0.001 to 2.000
Default	1.000
Usage	Program/Immediate, Read/Write
Code Example	<pre>CR=1.500 `Ratio set to 1.5</pre>
Notes	<p>A value of 1.00 has no acceleration or deceleration. All other values use the value of A and D.</p> <p>The value of CR will have no impact on a clock output. CR will impact Step/Direction in, Clock Up/ Clock Down in and Quadrature in when I/O 7 and 8 are configured as inputs.</p>
Related	S7, S8, CM, CW

CT (Calibration time)

Compatible with Motion Control products:
MDrive Hybrid
MDrive Hybrid (Ethernet)

Mnemonic	CT
Function	Set calibration time
Type	Variable
Description	The CT variable will set the calibration time in milliseconds.
Syntax	CT=<time>
Units	Milliseconds
Range	2 — 65535
Default	200 mS
Usage	Program/Immediate, Read/Write
Code Example	CT=1000 `set calibration time to 1S
Related	CA, CC

CW (Clock width)

Compatible with Motion Control products:
MDrive (Plus² expanded features)
MDrive (Ethernet)
MDrive Hybrid
MForce (Plus² expanded features)

Mnemonic	CW
Function	Set clock width
Type	Variable
Description	When CM=1 and I/O 7 and 8 are configured as outputs, CW sets the pulse width of the output signal. The setting will be a multiplier x 50 nS. CW will set the output clock pulse width for: Step Clock out, Clock Up/Clock Down out, Quadrature out and the Trip output (I/O 13).
Syntax	CW=<time>
Units	Nanoseconds
Range	0 - 255
Default	500 nS
Usage	Program/Immediate, Read/Write
Code Example	CW=100 `output step width to 5µS (100 x 50nS)
Related	S7, S8, S13, CM, PC

D (Deceleration)

Compatible with Motion Control products:
 MDrive
 MDrive (Plus² expanded features)
 MDrive (Ethernet)
 MDrive Hybrid
 MDrive Hybrid (Ethernet)
 MForce
 MForce (Plus² expanded features)

Mnemonic	D
Function	Set deceleration
Type	Variable
Description	The D variable sets the deceleration of the device in steps per second ² . If the D was set at 76800 per second ² the motor would decelerate at a rate of 76800 per second ² every second. If the device was running at a maximum velocity of 768000 microsteps per second it would take 10 seconds to decelerate if VI=0.
Syntax	D=<steps/counts>
Units	Steps/Sec ² (EE=0)/Counts/Sec ² (EE=1)
Range	91 to 1525878997 (Steps EE=0), 91 to 61035160 (Counts EE=1)
Default	1000000(EE=0), 40000 (EE=1)
Usage	Program/Immediate, Read/Write
Code Example	D=20000 `set acceleration to 20000 step/sec2 D=A `set deceleration equal to acceleration
Related	A, C1, C2, P

D1-D4 (Input switch debounce)

Compatible with Motion Control products:
 MDrive
 MDrive (Plus² expanded features)
 MDrive (Ethernet)
 MDrive Hybrid
 MDrive Hybrid (Ethernet)
 MForce
 MForce (Plus² expanded features)

Mnemonic	D1-D4
Function	Set input switch debounce
Type	Variable
Description	This variable will set the digital filtering to be applied to the selected input 1 - 4. The input must be stable for "time" amount of milliseconds before a change in state is detected.
Syntax	D1-4=<time>
Units	Milliseconds
Range	0 to 255
Default	0
Usage	Program/Immediate, Read/Write
Code Example	D1=0 `No debounce D1=150 `Set filtering to 150 msec
Related	I1 - I4

D5 (Analog input filter)

Compatible with Motion Control products:
 MDrive
 MDrive (Plus² expanded features)
 MDrive (Ethernet)
 MDrive Hybrid
 MDrive Hybrid (Ethernet)
 MForce
 MForce (Plus² expanded features)

Mnemonic	D5
Function	Set analog input filter
Type	Variable
Description	D5 is a continuous filtering process. It does a running average by computing: $(((X-1)/X)*\text{current reading}) + (1 / X)$ If X = 10, then: $((\text{current averaged value} * 9)/10) + (\text{new reading} / 10) == \text{NEW current averaged value.}$
Syntax	D5=<X>
Units	Counts
Range	0 to 255
Default	0
Usage	Program/Immediate, Read/Write
Code Example	D5=0 'No debounce D5=100 'Set filtering to 100 counts

D9-D12 (Input switch debounce)

Compatible with Motion Control products:
 MDrive (Plus² expanded features)
 MDrive (Ethernet)
 MDrive Hybrid
 MForce (Plus² expanded features)

Mnemonic	D9-D12
Function	Set input switch debounce
Type	Variable
Description	This variable will set the digital filtering to be applied to the selected input 9 - 12. The input must be stable for "time" amount of milliseconds before a change in state is available.
Syntax	D9-12=<time>
Units	Milliseconds
Range	0 to 255
Default	0
Usage	Program/Immediate, Read/Write
Code Example	D10=0 'No debounce on input 10 D11=150 'Set filtering to 150 msec on input 11
Related	I9 - I12

DB (Encoder deadband)

Compatible with Motion Control products:
 MDrive
 MDrive (Ethernet)
 MDrive (Plus² expanded features)
 MForce
 MForce (Plus² expanded features)

Mnemonic	DB
Function	Set encoder deadband
Type	Variable
Description	This variable defines the plus (+) and minus (-) length of the encoder deadband in encoder counts. When the encoder is enabled, a move is not completed until motion stops within DB. If PM=1 device will correct if pushed outside of DB value once in position.
Syntax	DB=<counts>
Units	Encoder counts
Range	0 to 65000
Default	1
Usage	Program/Immediate, Read/Write
Code Example	DB=10 `Set encoder deadband to ±10 counts
Related	EE, C2, SF, SM, ST, PM, EL

DC (Decrement variable)

Compatible with Motion Control products:
 MDrive
 MDrive (Plus² expanded features)
 MDrive (Ethernet)
 MDrive Hybrid
 MDrive Hybrid (Ethernet)
 MForce
 MForce (Plus² expanded features)

Mnemonic	DC
Function	Decrement variable
Type	Instruction
Description	The DC instruction will decrement the specified variable by one.
Syntax	DC <variable>
Usage	Program/Immediate, Read/Write
Code Example	DC R1 `Decrement register r1 DC K5 `Decrement user variable K5
Related	IC

DE (Drive enable)

Compatible with Motion Control products:
 MDrive
 MDrive (Plus² expanded features)
 MDrive (Ethernet)
 MDrive Hybrid
 MDrive Hybrid (Ethernet)
 MForce
 MForce (Plus² expanded features)

Mnemonic	DE
Function	Set drive enabled/disabled
Type	Variable
Description	The DE flag enables or disables the drive portion of the MCode compatible device.
Syntax	DE=<0/1>
Range	0/1
States	0 Drive output bridge disabled. 1 Drive output bridge enabled (default).
Default	1
Usage	Program/Immediate, Read/Write
Code Example	DE=0 'Disable the motor driver section DE=1 'Enable the motor driver section

DG (Disable global response)

Compatible with Motion Control products:
 MDrive
 MDrive (Plus² expanded features)
 MDrive Hybrid
 MForce
 MForce (Plus² expanded features)

Mnemonic	DG
Function	Enable/disable global response in party mode
Type	Flag
Description	The DG flag enables or disables device response to global commands made while in Party Mode. In the default state (DG=1) the device will not respond but will execute global commands. By setting the the DG flag to 0, that device will respond to global commands.
Syntax	DG=<0/1>
Range	0/1
States	0 Response to global commands enabled. 1 Response to global commands disabled (default).
Default	1 (disabled)
Usage	Program/Immediate, Read/Write
Code Example	DG=0 'Enable response to global commands DG=1 'Disable Response to global commands no echo
Related	DN, PY

DN (Device name)

Compatible with Motion Control products:
 MDrive
 MDrive (Plus² expanded features)
 MDrive Hybrid
 MForce
 MForce (Plus² expanded features)

Mnemonic	DN
Function	Set device name for party mode.
Type	Variable
Description	<p>DN sets the name of the device for party mode communications. The acceptable range of characters is a-z, A-Z, 0-9. The factory default is "!" Once named, the device name must precede the instruction to that drive. When assigning a device name, the character MUST be within quotation marks.</p> <p>The name is case sensitive. Refer to Section 2.2 in the Hardware Reference for specific Party Mode configuration and use instructions.</p> <p>Once the default character has been changed it can not be reset except on a FD (Factory Default Reset).</p>
Syntax	DN=<"ascii character">
Units	ASCII Characters
Range	a-z, A-Z, 0-9
Default	!
Usage	Program/Immediate, Read/Write
Code Example	<pre>DN="A" `Set the device name to the character A DN="65" `Set the device name to the character A*</pre>
Notes	Note: Must enter S (Save) prior to any reset of the DN will be lost.
Related	PY, S

E (End program)

Compatible with Motion Control products:
 MDrive
 MDrive (Plus² expanded features)
 MDrive (Ethernet)
 MDrive Hybrid
 MDrive Hybrid (Ethernet)
 MForce
 MForce (Plus² expanded features)

Mnemonic	E
Function	End program
Type	Instruction
Description	Stops the execution of a program. Used in program mode to designate the end of the program
Syntax	E
Usage	Program
Code Example	E `End program
Related	PG, EX

EE (Encoder enable)

Compatible with Motion Control products:
 MDrive
 MDrive (Plus² expanded features)
 MForce
 MForce (Plus² expanded features)

Mnemonic	EE
Function	Enable/disable encoder
Type	Flag
Description	The EE flag enables or disables the optional encoder mode of the MCode compatible device. When in Encoder Mode, all moves are done by Encoder Counts. The 512 line Encoder generates counts in a Quadrature format which results in 2048 counts per revolution.
Syntax	EE=<0/1>
Range	0/1
States	0 Disable the encoder (default state) 1 Enable the encoder
Default	0 (disabled)
Usage	Program/Immediate, Read/Write
Code Example	EE=0 'Disable the encoder EE=1 'Enable encoder mode
Related	DB, C2, SF, SM, ST, PM, FM, EL

EF (Error flag)

Compatible with Motion Control products:
 MDrive
 MDrive (Plus² expanded features)
 MDrive (Ethernet)
 MDrive Hybrid
 MDrive Hybrid (Ethernet)
 MForce
 MForce (Plus² expanded features)

Mnemonic	EF
Function	Error condition exists
Type	Flag
Description	The Error flag will indicate whether or not an error condition exists. It is automatically cleared when a new program is executed. The only way to manually clear the EF flag is to read the value of the ER variable or set ER=0. There is an instruction, OE, which allows the user to specify the execution of a subroutine in the program memory when an error occurs. The subroutine might contain instructions to read the ER variable which would clear the EF flag.
Syntax	PR EF
Response	0/1
States	0 No error exists 1 Error condition exists
Default	0 (disabled)
Usage	Program/Immediate, Read
Code Example	PR EF 'Read the state of the error flag 'Response = 0: No error exists 'Response = 1: Error condition exists, 'Error value exists
Related	ER, OE

EL (Remote encoder line count)

Compatible with Motion Control products:
 MDrive (Plus² expanded features)
 MDrive Hybrid
 MForce (Plus² expanded features)

Mnemonic	EL
Function	Set remote encoder line count.
Type	Variable
Description	<p>This variable defines the number of encoder lines that the device will see in a revolution. Counter 2 will read 4 x EL, or 4 counts per line.</p> <p>Note : The setting for MS (Microstep Resolution) is relative to the EL Setting. To calculate the minimum value for MS use the following equation:</p> $\text{MS minimum} = (\text{EL} \times 8) \div 200$ <p>Example for 1000 line encoder: $1000 \times 8 = 8000$, $8000 \div 200 = 40$</p> <p>Minimum Microstep Resolution = 50, or 10000 steps/rev. Note: We recommend leaving the Microstep Resolution at the default of 256.</p>
Syntax	EL=<lines>
Units	Encoder lines
Default	512 (1000 for MDrive Hybrid)
Usage	Program/Immediate, Read/Write
Code Example	<pre>EL=1000 `Config EL variable for 1000 line encoder MS=50 `Config microstep res to 10000 steps/rev</pre>
Related	C2, MS, SF, SM, ST, PM, FM

EM (Echo mode)

Compatible with Motion Control products:
 MDrive
 MDrive (Plus² expanded features)
 MDrive (Ethernet)
 MDrive Hybrid
 MDrive Hybrid (Ethernet)
 MForce
 MForce (Plus² expanded features)

Mnemonic	EM
Function	Set echo mode
Type	Flag
Description	The Echo Mode Flag will set the full/half duplex configuration of the RS-485 channel.
Syntax	EM=<0-3>
Range	0 - 3
States	<p>Echo all information back over communications line. CR/LF indicates command accepted (full duplex) (default).</p> <p>0</p> <p>1 Don't echo the information, only send back prompt. CR/LF indicates command accepted (half duplex).</p> <p>2 Does not send prompt, only responds to PRINT (PR) and LIST (L) commands.</p> <p>3 Saves Echo in Print Queue then executes. Prints after command is terminated.</p>
Default	0 (disabled)
Usage	Program/Immediate, Read
Code Example	<pre>EM=1 `Don't echo the information,</pre>
Related	ER, OE

ER (Error)

Compatible with Motion Control products:
 MDrive
 MDrive (Plus² expanded features)
 MDrive (Ethernet)
 MDrive Hybrid
 MDrive Hybrid (Ethernet)
 MForce
 MForce (Plus² expanded features)

Mnemonic	ER
Function	Display error code
Type	Variable
Description	The ER variable indicates the MCode device error code for the most recent error that has occurred. The ER variable must be read or set to zero to clear the EF flag. A Question Mark <?> in place of the normal cursor indicates an ERROR. A list of Error codes are located at the end of this section..
Syntax	PR ER
Units	Numeric error code
Default	0
Usage	Program/Immediate, Read/Write
Code Example	PR ER 'Read the error number, result = <Value> ER 0 'Set the error value to zero
Notes	Note: See Error code section for full listing of error codes.
Related	EF, OE

ES (Escape)

Compatible with Motion Control products:
 MDrive
 MDrive (Plus² expanded features)
 MDrive (Ethernet)
 MDrive Hybrid
 MDrive Hybrid (Ethernet)
 MForce
 MForce (Plus² expanded features)

Mnemonic	ES								
Function	Set escape mode								
Type	Flag								
Description	ESC flag to switch between ESC and CTRL+E. An Escape will stop both the program and the motion.								
Syntax	ES=<0-3>								
Range	0 - 3								
Modes	<table border="0"> <tr> <td>0</td> <td>Escape Flag set to respond to CTRL+E</td> </tr> <tr> <td>1</td> <td>Escape Flag set to respond to ESC keypress (default)</td> </tr> <tr> <td>2</td> <td>Escape Flag set to respond addressable CTRL+E (party mode)</td> </tr> <tr> <td>3</td> <td>Escape Flag set to respond to addressable ESC keypress (party mode)</td> </tr> </table>	0	Escape Flag set to respond to CTRL+E	1	Escape Flag set to respond to ESC keypress (default)	2	Escape Flag set to respond addressable CTRL+E (party mode)	3	Escape Flag set to respond to addressable ESC keypress (party mode)
0	Escape Flag set to respond to CTRL+E								
1	Escape Flag set to respond to ESC keypress (default)								
2	Escape Flag set to respond addressable CTRL+E (party mode)								
3	Escape Flag set to respond to addressable ESC keypress (party mode)								
Default	1								
Usage	Program/Immediate, Read/Write								
Code Example	ESC=0 'ESC responds to CTRL+E								

EX (Execute program)

Compatible with Motion Control products:
 MDrive
 MDrive (Plus² expanded features)
 MDrive (Ethernet)
 MDrive Hybrid
 MDrive Hybrid (Ethernet)
 MForce
 MForce (Plus² expanded features)

Mnemonic	EX
Function	Execute program
Type	Instruction
Description	Execute program at a specified address or label using a selected trace mode. Used in immediate mode. There are three modes of program execution.
Syntax	EX <address/label>,<mode>
Modes	<p>0 Normal execution, is specified by a mode of 0 (or simply leaving the mode blank).</p> <p>1 Trace mode is specified by a mode of 1. This means that the program executes continuously until the program E is encountered, but the instructions are “traced” to the communications port so the user can see what instructions have been executed.</p> <p>2 Single step mode is specified by a mode of 2. In this mode, the user can step through the program using the space bar to execute the next line of the program. The program can be resumed at normal speed in this mode by pressing the enter key.</p>
Usage	Immediate
Code Example	<pre>EX 1 'Execute program at address 1 normally EX G2,1 'Execute program G2 in trace mode EX 200,2 'Execute program at address 200 in 'single-step mode</pre>

FC (Filter capture)

Compatible with Motion Control products:
 MDrive
 MDrive (Plus² expanded features)
 MDrive (Ethernet)
 MDrive Hybrid
 MDrive Hybrid (Ethernet)
 MForce
 MForce (Plus² expanded features)

Mnemonic	FC
Function	Set filtering for the capture input.
Type	Variable
Description	This variable will set the digital filtering to be applied to I/O 13 when configured as a Capture input. The input must be stable for “time” amount of milliseconds before a change in state is detected.

Input 13 Filter Capture Settings

Range	Min Pulse	Cutoff Frequency
0	50 nS	10 MHz
1	150 nS	3.3 MHz
2	200 nS	2.5 MHz
3	300 nS	1.67 MHz
4	500 nS	1.0 MHz
5	900 nS	555 kHz
6	1.7 μ S	294.1 kHz
7	3.3 μ S	151 kHz
8	6.5 μ S	76.9 kHz
9	12.9 μ S	38.8 kHz

Syntax	FC=<0-9>
Range	0 to 9
Units	Numeric
Default	0 (min pulse 50 nS, cutoff of 10 MHz)
Usage	Program/Immediate, Read/Write
Code Example	FC=2 `Set filtering for Input 13 min pulse to 200 `nS/CO 2.5 MHz
Related	I13, TC, S13

FD (Restore factory defaults)

Compatible with Motion Control products:
 MDrive
 MDrive (Plus² expanded features)
 MDrive (Ethernet)
 MDrive Hybrid
 MDrive Hybrid (Ethernet)
 MForce
 MForce (Plus² expanded features)

Mnemonic	FD
Function	Restore factory default settings
Type	Instruction
Description	FD will clear all program memory and return the MCode compatible device to factory default settings. The response will be the sign on message. FD will clear programs and initialize parameters.
Syntax	FD <carriage return>
Usage	Immediate
Code Example	FD `Restore device to factory default state Response "Copyright 2001-2007 by Intelligent Motion Systems, Inc."
Notes	FD will generate an error 73 if the unit is in motion.
Related	CP, IP

FM (Filter motion)

Compatible with Motion Control products:
 MDrive (Plus² expanded features)
 MForce (Plus² expanded features)

Mnemonic	FM																																				
Function	Set filtering for the motion inputs.																																				
Type	Variable																																				
Description	Filter Motion inputs, I/O 7 & 8 for electronic gearing and optional encoder.																																				
	<table border="1"> <thead> <tr> <th colspan="3">Input 7 & 8 Filter Settings</th> </tr> <tr> <th>Range</th> <th>Min Pulse</th> <th>Cutoff Frequency</th> </tr> </thead> <tbody> <tr> <td>0</td> <td>50 nS</td> <td>10 MHz</td> </tr> <tr> <td>1</td> <td>150 nS</td> <td>3.3 MHz</td> </tr> <tr> <td>2</td> <td>200 nS</td> <td>2.5 MHz</td> </tr> <tr> <td>3</td> <td>300 nS</td> <td>1.67 MHz</td> </tr> <tr> <td>4</td> <td>500 nS</td> <td>1.0 MHz</td> </tr> <tr> <td>5</td> <td>900 nS</td> <td>555 kHz</td> </tr> <tr> <td>6</td> <td>1.7 μS</td> <td>294.1 kHz</td> </tr> <tr> <td>7</td> <td>3.3 μS</td> <td>151 kHz</td> </tr> <tr> <td>8</td> <td>6.5 μS</td> <td>76.9 kHz</td> </tr> <tr> <td>9</td> <td>12.9 μS</td> <td>38.8 kHz</td> </tr> </tbody> </table>	Input 7 & 8 Filter Settings			Range	Min Pulse	Cutoff Frequency	0	50 nS	10 MHz	1	150 nS	3.3 MHz	2	200 nS	2.5 MHz	3	300 nS	1.67 MHz	4	500 nS	1.0 MHz	5	900 nS	555 kHz	6	1.7 μ S	294.1 kHz	7	3.3 μ S	151 kHz	8	6.5 μ S	76.9 kHz	9	12.9 μ S	38.8 kHz
Input 7 & 8 Filter Settings																																					
Range	Min Pulse	Cutoff Frequency																																			
0	50 nS	10 MHz																																			
1	150 nS	3.3 MHz																																			
2	200 nS	2.5 MHz																																			
3	300 nS	1.67 MHz																																			
4	500 nS	1.0 MHz																																			
5	900 nS	555 kHz																																			
6	1.7 μ S	294.1 kHz																																			
7	3.3 μ S	151 kHz																																			
8	6.5 μ S	76.9 kHz																																			
9	12.9 μ S	38.8 kHz																																			
Syntax	FM=<0-9>																																				
Range	0 to 9																																				
Units	Numeric																																				
Default	Default: 2 (min pulse 200 nS, cutoff of 2.5 MHz)																																				
Usage	Program/Immediate, Read/Write																																				
Code Example	FM=3 `Set filtering for motion min pulse to 300 `nS/CO 1.67 MHz																																				
Related	I7, I8, C2, EL, EE, S7, S8																																				

FT (Internal use only)

Mnemonic	FT
Function	Factory use only
Description	Will return an error if used. Do not use for a user program label, variable or flag..

H (Hold program execution)

Compatible with Motion Control products:
 MDrive
 MDrive (Plus² expanded features)
 MDrive (Ethernet)
 MDrive Hybrid
 MDrive Hybrid (Ethernet)
 MForce
 MForce (Plus² expanded features)

Mnemonic	H
Function	Hold program execution
Type	Instruction
Description	<p>The hold instruction is used in a program to suspend program execution. If no parameter is specified the execution of the program will be suspended while motion is in progress. This will typically be used following a MA, MR, HI or HM instruction.</p> <p>A time in milliseconds may be placed as a parameter to the hold instruction, This will suspend program execution for the specified number of milliseconds.</p>
Syntax	H <time>
Units	Milliseconds
Range	1 - 65000
Usage	Program/Immediate
Code Example	<pre>MA 1000 ` Move Absolute 1000 steps H `Suspend prog ex. until motion completes `(used after a move command) H 2000 `Suspend program execution for 2 seconds</pre>
Related	PG, E, EX

HC (Motor holding current)

Compatible with Motion Control products:
 MDrive
 MDrive (Plus² expanded features)
 MDrive (Ethernet)
 MDrive Hybrid
 MDrive Hybrid (Ethernet)
 MForce
 MForce (Plus² expanded features)

Mnemonic	HC			
Function	Motor holding current			
Type	Variable			
Description	This variable defines the motor holding current in percent.			
	HC=(%)	MDrive MDrive Hybrid (All)	MForce MicroDrive (A RMS)	MForce PowerDrive (A RMS)
	10	MDrive Range 0 To 100%	0.3	0.5
	20		0.6	1.0
	30		0.9	1.5
	40	Actual Current Not required as Motor is appropriately sized to the device.	1.2	2.0
	50		1.5	2.5
	60		1.8*	3.0
	70		2.1	3.5
	80		2.4	4.0
	90		2.7	4.5
	100		3.0	5.0
Syntax	HC=<percent>			
Units	Percent			
Range	0 to 100			
Default	5%			
Usage	Program/Immediate, Read/Write			
Code Example	HC=25 'set holding current to 25%			
Related	RC, HT			

HI (Home to index mark)

Compatible with Motion Control products:
 MDrive
 MDrive (Plus² expanded features)
 MDrive (Ethernet)
 MDrive Hybrid
 MDrive Hybrid (Ethernet)
 MForce
 MForce (Plus² expanded features)

Mnemonic	HI								
Function	Home to index mark								
Type	Instruction								
Description	<p>This instruction will find the the encoder index mark. There are four combinations for this command. (See Use below.)</p> <p>When HI is executed, the axis moves in the direction specified by the (S) at VM until it reaches the index mark. It then creeps off of the index in the direction specified by the sign of (C) at VI. Motion is stopped as soon as the index changes state. Note that Speed and Creep is set by the VM and VI commands.</p> <ol style="list-style-type: none"> Speed: Specifies the direction and speed that the axis will move until the switch is activated (VM). Creep: Specifies the direction and speed that the axis will move off the switch until it becomes inactive again (VI). 								
Syntax	HI <type>								
Range	1 - 4								
Modes	<table border="1"> <tr> <td>1</td> <td>Slew at VM in the minus direction and Creep at VI in the plus direction.</td> </tr> <tr> <td>2</td> <td>Slew at VM in the minus direction and Creep at VI in the minus direction.</td> </tr> <tr> <td>3</td> <td>Slew at VM in the plus direction and Creep at VI in the minus direction.</td> </tr> <tr> <td>4</td> <td>Slew at VM in the plus direction and Creep at VI in the plus direction.</td> </tr> </table>	1	Slew at VM in the minus direction and Creep at VI in the plus direction.	2	Slew at VM in the minus direction and Creep at VI in the minus direction.	3	Slew at VM in the plus direction and Creep at VI in the minus direction.	4	Slew at VM in the plus direction and Creep at VI in the plus direction.
1	Slew at VM in the minus direction and Creep at VI in the plus direction.								
2	Slew at VM in the minus direction and Creep at VI in the minus direction.								
3	Slew at VM in the plus direction and Creep at VI in the minus direction.								
4	Slew at VM in the plus direction and Creep at VI in the plus direction.								
Usage	Program/Immediate								
Code Example	<pre>HI 2 `Slew at VM minus direction and Creep at VI in the `minus direction</pre>								
Related	VM, VI, EE, I6, HM								

HM (Home to home switch)

Compatible with Motion Control products:
 MDrive
 MDrive (Plus² expanded features)
 MDrive (Ethernet)
 MDrive Hybrid
 MDrive Hybrid (Ethernet)
 MForce
 MForce (Plus² expanded features)

Mnemonic	HM
Function	Home to home switch
Type	Instruction
Description	<p>This instruction will find the selected I/O switch assigned to “Home”.</p> <ol style="list-style-type: none"> 1. Speed: Specifies the direction and speed that the axis will move until the switch is activated (VM). 2. Creep: Specifies the direction and speed that the axis will move off the switch until it becomes inactive again (VI). <p>When HM is executed, the axis moves at VM in the direction specified by the sign of speed. It then creeps off of the switch at VI in the direction specified by the sign of creep. Motion is stopped as soon as the switch becomes deactivated. Note that Speed and Creep is set by the VM and VI commands.</p> <p>The diagram on the following page illustrates the different scenarios possible during the Homing (HM) sequence. The diagrams represent the four HM commands. Below are the four combinations of the HM command.</p>
Syntax	HI <type>
Range	1 - 4
Modes	<ol style="list-style-type: none"> 1 Slew at VM in the minus direction and Creep at VI in the plus direction. 2 Slew at VM in the minus direction and Creep at VI in the minus direction. 3 Slew at VM in the plus direction and Creep at VI in the minus direction. 4 Slew at VM in the plus direction and Creep at VI in the plus direction.
Usage	Program/Immediate
Code Example	<pre>HM 2 `Slew at VM minus direction and Creep at VI in the `minus direction</pre>
Related	VM, VI, EE, I6, HI, LM, S<1-4>, <9-12>

The key to the diagrams is as follows.

1. Slew at VM to find the Index Mark.
2. Decelerate to zero (0) after finding the Index Mark.
3. Creep at VI away from the Index Mark.
4. Stop when at the edge of the Index Mark.

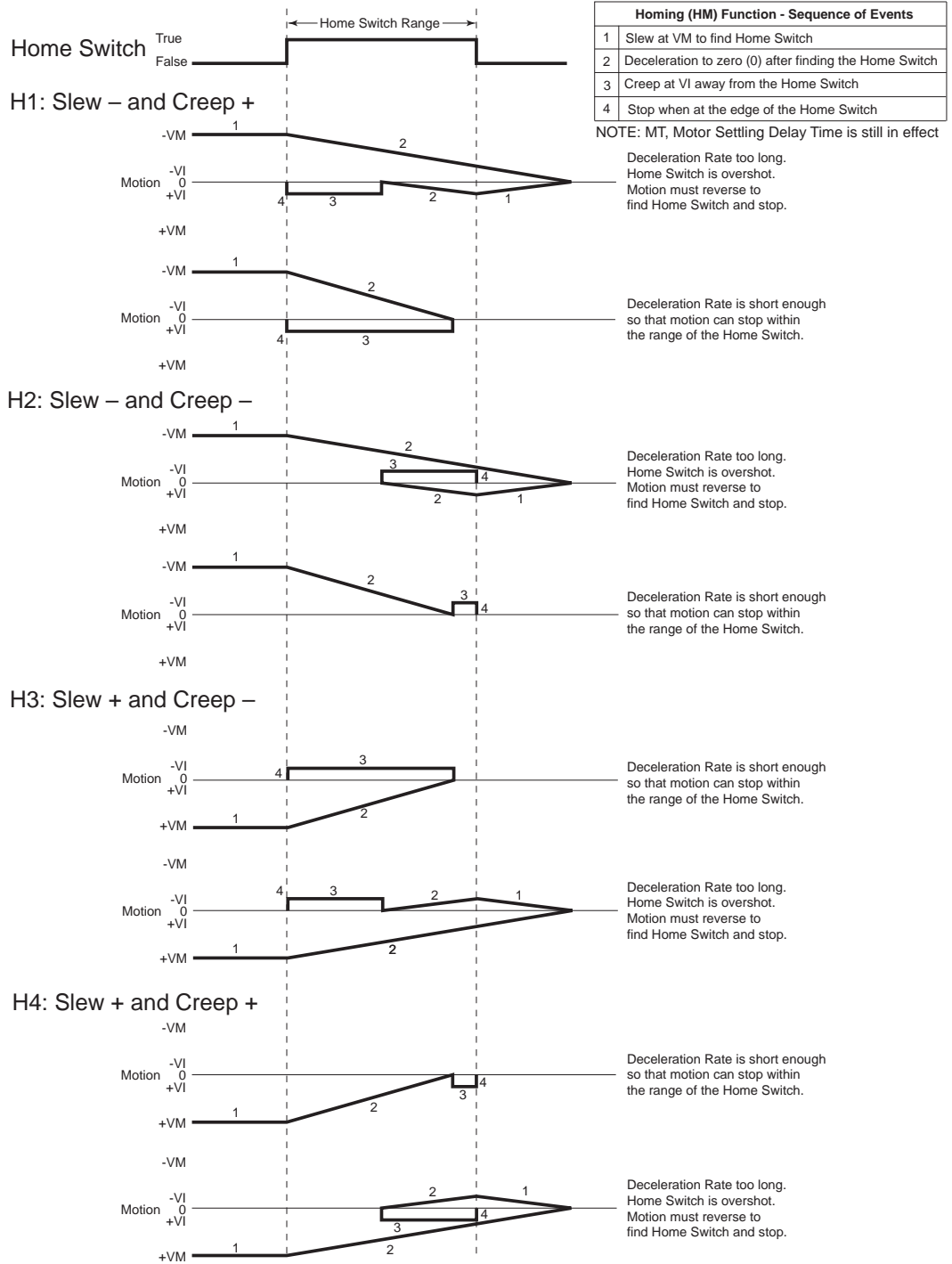

Figure 5.1 Homing functions sequence of events

HT (Hold current delay time)

Compatible with Motion Control products:
 MDrive
 MDrive (Plus² expanded features)
 MDrive (Ethernet)
 MDrive Hybrid
 MDrive Hybrid (Ethernet)
 MForce
 MForce (Plus² expanded features)

Mnemonic	HT
Function	Holding current delay time
Type	Variable
Description	<p>The HT variable sets the delay time in milliseconds between the MV=0 and when the device shifts to the holding current level specified by the HC (Motor Holding Current) variable. The delay time is also effected by the MT (Motor Settling Delay Time) variable in that the total time to current change is represented by the sum of MT + HT. The total of MT+HT cannot add up to more than 65535, thus the value of MT is included in the HT range.</p> <p>Thus the Maximum setting for HT=(65535-MT). If HT=0, the current will not reduce.</p>
Syntax	HT=<time>
Units	Milliseconds
Range	0 or 2 - 65535
Default	500 ms
Usage	Program/Immediate. Read/Write
Code Example	HT=1500 `set hold current delay time to 1.5 seconds
Related	HC, MT, RC

HT (Hold current delay time)

Compatible with Motion Control products:
 MDrive Legacy

 CAUTION
The HT command functions differently on legacy MDrive products than on current MDrive products in that if HT is set to 0, the current will reduce immediately.
Failure to follow these instructions can result in equipment damage.

Mnemonic	HT
Function	Holding current delay time
Type	Variable
Description	<p>The HT variable sets the delay time in milliseconds between the MV=0 and when the device shifts to the holding current level specified by the HC (Motor Holding Current) variable. The delay time is also effected by the MT (Motor Settling Delay Time) variable in that the total time to current change is represented by the sum of MT + HT. The total of MT+HT cannot add up to more than 65535, thus the value of MT is included in the HT range.</p> <p>Thus the Maximum setting for HT=(65535-MT). If HT=0, the current will reduce. immediately.</p>
Syntax	HT=<time>
Units	Milliseconds
Range	0 or 2 - 65535
Default	500 ms
Usage	Program/Immediate. Read/Write
Code Example	HT=1500 `set hold current delay time to 1.5 seconds
Related	HC, MT, RC

I1, I2, I3 and I4 (Read inputs 1, 2, 3 or 4)

Compatible with Motion Control products:
 MDrive
 MDrive (Plus² expanded features)
 MDrive (Ethernet)
 MDrive Hybrid
 MDrive Hybrid (Ethernet)
 MForce
 MForce (Plus² expanded features)

Mnemonic	I1 - I4
Function	Read the state of inputs 1 - 4
Type	Variable
Description	This variable will read the state of the specified input 1 - 4. Can be used with PR (Print), BR (Branch) and CL (Call Subroutine) instructions. Can also be used with R1 - R4 and User Variables. The value of the bit state will be dependant on active (low/high) state of the input, specified by the S<1-4> 2nd parameter.
Syntax	PR I<1-4> BR <addr/lbl>, I<1-4>=<1/0> CL<addr/lbl>, I<1-4>=<1/0>
Units	Logic 0 or 1
Range	0/1
Usage	Program/Immediate. Read
Code Example	<pre>PR I2 `Prints the logic state of input 2 BR 128,I3=1 `Cond branch to address 125, Input 3 ACTIVE CL K9, I4=0 `Call subroutine K9, Input 4 INACTIVE</pre>
Related	IL, IN, O1-O4, S1-S4

I5 (Read analog input)

Compatible with Motion Control products:

MDrive
 MDrive (Plus² expanded features)
 MDrive (Ethernet)
 MDrive Hybrid
 MDrive Hybrid (Ethernet)
 MForce
 MForce (Plus² expanded features)

Mnemonic	I5
Function	Read the value of the analog input
Type	Variable
Description	<p>This variable will read the value of the correlating bit value seen on the Analog Input. Can be used with PR (Print), BR (Branch) and CL (Call Subroutine) instructions. The value read will between 0 and 1023.</p> <p>This value represents a voltage or current being seen on the analog input. for example, if in current mode (0 - 20mA range) 1023 would represent 20 mA, 512 would represent 10 mA.</p>
Syntax	<pre>PR I5 BR <addr/lbl>,I5=<0-1023> CL<addr/lbl>, I5<0-1023></pre>
Units	Numeric value
Range	0 to 1023
Usage	Program/Immediate. Read
Code Example	<pre>PR I5 `Print the value of I5 BR G3,I5>512 `Branch to prog G3 if I5 is > 512 CL 423,I5<220 `Call sub at address 423 if I5 is < 220</pre>
Related	S5

I6 (Read encoder index mark)

Compatible with Motion Control products:

MDrive
 MDrive (Plus² expanded features)
 MDrive (Ethernet)
 MDrive Hybrid
 MDrive Hybrid (Ethernet)
 MForce
 MForce (Plus² expanded features)

Mnemonic	I6
Function	Read the state of the encoder index mark
Type	Variable
Description	<p>This variable will read the on/off state of the Encoder Index Mark. Can be used with PR (Print), BR (Branch) and CL (Call Subroutine) instructions. The value read will be 0 (off mark) or 1 (on mark).</p>
Syntax	<pre>PR I6 BR <addr/lbl>,I6=<0/1> CL<addr/lbl>, I6<0/1></pre>
Units	Logic state 0 or 1
Range	0/1
Usage	Program/Immediate. Read
Code Example	<pre>PR I6 `Print state of the encoder index mark BR 324,I6=1 `Branch to address 324 if I6 is ACTIVE CL K3,I6=1 `Call subroutine K3 if I6 is ACTIVE</pre>
Related	S5

I7, I8 (Reserved)

Mnemonic	I7, I8
Function	Reserved, do not use as a user variable, flag or label.

I9, I10, I11 and I2 (Read inputs 9, 10, 11 or 12)

Compatible with Motion Control products:
 MDrive (Plus² expanded features)
 MDrive (Ethernet)
 MDrive Hybrid
 MForce (Plus² expanded features)

Mnemonic	I9 - I12
Function	Read the state of inputs 9 - 12
Type	Variable
Description	This variable will read the state of the specified input 9 - 12. Can be used with PR (Print), BR (Branch) and CL (Call Subroutine) instructions. Can also be used with R1 - R4 and User Variables. The value of the bit state will be dependant on active (low/high) state of the input, specified by the S<9-12> 2nd parameter.
Syntax	PR I<9-12> BR <addr/lbl>, I<9-12>=<1/0> CL<addr/lbl>, I<9-12>=<1/0>
Units	Logic 0 or 1
Range	0/1
Usage	Program/Immediate. Read
Code Example	<pre>PR I12 `Prints the logic state of input 12 BR 128,I9=1 `Cond branch to address 125, Input 9 ACTIVE CL K9, I8=0 `Call subroutine K9, Input 8 INACTIVE</pre>
Related	IL, IN, O1-O4, S1-S4

I13 (Reserved)

Mnemonic	I13
Function	Reserved, do not use as a user variable, flag or label.

IC (Increment variable)

Compatible with Motion Control products:
 MDrive
 MDrive (Plus² expanded features)
 MDrive (Ethernet)
 MDrive Hybrid
 MDrive Hybrid (Ethernet)
 MForce
 MForce (Plus² expanded features)

Mnemonic	IC
Function	Increment variable
Type	Instruction
Description	The IC instruction will increment the specified variable by one.
Syntax	IC <variable>
Usage	Program/Immediate, Read/Write
Code Example	<pre>IC R1 `Increment register r1 IC K5 `Increment user variable K5</pre>
Related	DC

IF (Input variable pending)

Compatible with Motion Control products:
 MDrive
 MDrive (Plus² expanded features)
 MDrive (Ethernet)
 MDrive Hybrid
 MDrive Hybrid (Ethernet)
 MForce
 MForce (Plus² expanded features)

Mnemonic	IF
Function	Input variable pending
Type	Flag
Description	The IF instruction is automatically set to 1 when IV command is executed. The IF flag reflects an input value from serial port is pending, not that one has been received. IF will be cleared to zero (0) with a carriage return or can be reset manually.
Syntax	<user input><CR> IF=<0/1>
States	0 No variable input pending 1 Variable input pending
Default	0
Usage	Program/Immediate, Read
Code Example	No Usage Example, Flag set automatically by IV

IL (Read inputs 1 - 4 as a group)

Compatible with Motion Control products:
 MDrive
 MDrive (Plus² expanded features)
 MDrive (Ethernet)
 MDrive Hybrid
 MDrive Hybrid (Ethernet)
 MForce
 MForce (Plus² expanded features)

Mnemonic	IL
Function	Read the state of inputs 1 - 4 as one value
Type	Variable
Description	This keyword will read the binary state of inputs 1-4 and print them as a decimal value. When used thus, Input 1 is the Least Significant Bit (LSb) and Input 4 is the Most Significant Bit (MSb). It may be used in conjunction with the R1-R4 (Registers), PR (Print), BR (Branch) and CL (Call Subroutine) instructions. The value is a function of the actual voltage level of the I/O where 1 = +V and 0 = Ground. (Not a function of the active state defined in S1 to S4 variables).
Syntax	PR IL BR <addr/lb>,IL=<0-15> CL<addr/lb>, IL<0-15>
Units	Decimal
Range	0 —15
Usage	Program/Immediate. Read
Code Example	PR IL 'Print decimal value of IO4-IO1 BR 324,IL=8 'Branch to address 324 if IL=8 CL K3,IL=13 'Call subroutine K3 if IL=13
Related	IH, IN, OL, OH, OT, S1-S4

IH (Read inputs 9 - 12 as a group)

Compatible with Motion Control products:
 MDrive (Plus² expanded features)
 MDrive (Ethernet)
 MDrive Hybrid
 MForce (Plus² expanded features)

Mnemonic	IH
Function	Read the state of inputs 9 - 12 as one value
Type	Variable
Description	<p>This keyword will read the binary state of inputs 9-12 and print them as a decimal value. When used thus, Input 9 is the Least Significant Bit (LSb) and Input 12 is the Most Significant Bit (MSb). It may be used in conjunction with the R1-R4 (Registers), PR (Print), BR (Branch) and CL (Call Subroutine) instructions.</p> <p>The value is a function of the actual state of the I/O where 1 = +V and 0 = Ground. (Not a function of the active state defined in S9 to S12 variables)</p>
Syntax	<pre>PR IH BR <addr/lbl>,IH=<0-15> CL<addr/lbl>, IH<0-15></pre>
Units	Decimal
Range	0 —15
Usage	Program/Immediate. Read
Code Example	<pre>PR IH `Print decimal value of IO12-IO9 BR 324,IH=8 `Branch to address 324 if IH=8 CL K3,IH=13 `Call subroutine K3 if IH=13</pre>
Related	IL, IN, OL, OH, OT, S1-S4, S9-S12

IN (Read inputs 1 - 4 and 9 - 12 as a group)

Compatible with Motion Control products:
 MDrive
 MDrive (Plus² expanded features)
 MDrive (Ethernet)
 MDrive Hybrid
 MDrive Hybrid (Ethernet)
 MForce
 MForce (Plus² expanded features)

Mnemonic	IN
Function	Read the state of inputs 1 - 4 and 9 - 12 as one value
Type	Variable
Description	<p>This keyword will read the binary state of inputs 1-4 and 9-12 and print them as a decimal value. When used thus, Input 1 is the Least Significant Bit (LSb) and Input 12 is the Most Significant Bit (MSb). It may be used in conjunction with PR (Print), BR (Branch) and CL (Call Subroutine) instructions.</p> <p>The value is a function of the actual state of the IO where 1 = +V and 0 = Ground. (Not a function of the active state defined in S1 to S4 and S9 to S12 variables). On Standard Plus Models IN will only read the lower group (Inputs 1-4). The debounce function has no effect on the data read.</p>
Syntax	<pre>PR IN BR <addr/lbl>,IN=<0-255> CL <addr/lbl>, IN<0-255></pre>
Units	Decimal
Range	0 —255
Usage	Program/Immediate. Read
Code Example	<pre>PR IN `Print value of IO4-IO1 and IO9-IO12 BR 324,IN=225 `Branch to address 324 if IN=225 CL K3,IN=113 `Call subroutine K3 if IN=113</pre>
Notes	While tailored to Mdrive and MForce models with 8 I/O points, this command will function the same as IL on units with 4 I/O.
Related	IH, IL, OL, OH, OT, S1-S4, S9-S12

IP (Initialize parameters)

Compatible with Motion Control products:
 MDrive
 MDrive (Plus² expanded features)
 MDrive (Ethernet)
 MDrive Hybrid
 MDrive Hybrid (Ethernet)
 MForce
 MForce (Plus² expanded features)

Mnemonic	IP
Function	Initialize parameters
Type	Instruction
Description	The IP instruction will return all of the device variable and flag parameters to their stored values. If IP is used while the motor is moving an Error 74: Tried to Initialize Parameters of Clear Program while moving will be issued.
Syntax	IP
Usage	Program/Immediate
Code Example	IP 'initialize parameters
Related	S, FD

IT (Read internal temperature)

Compatible with Motion Control products:
 MDrive 34 DC and AC
 MDrive 34 (Plus²) DC and AC
 MDrive Hybrid
 MForce PowerDrive
 MForce (Plus²) PowerDrive

Mnemonic	IT
Function	Read the internal temperature of the device
Type	Variable
Description	Internal Temperature of the MCode compatible driver electronics. Only used on MDrive 34, AC input MDrive, MForce PowerDrive and MDrive Hybrid.
Syntax	PR IT
Units	Degrees
Range	-55°C to 125°C
Usage	Program/Immediate. Read
Code Example	PR IT 'Print the internal temperature to the terminal screen
Related	WT

IV (Input to variable)

Compatible with Motion Control products:
 MDrive
 MDrive (Plus² expanded features)
 MDrive (Ethernet)
 MDrive Hybrid
 MDrive Hybrid (Ethernet)
 MForce
 MForce (Plus² expanded features)

Mnemonic	IV
Function	Input data into variable
Type	Instruction
Description	<p>With the IV command, a user may input new variable values. These values must be numeric and will be input into the variable specified in the IV command.</p> <p>The variable used for the IV may be a system or USER Variable. A USER Variable must be declared prior to the IV command.</p> <p>When waiting for user input, there must be a conditional program loop based upon the state of IF (Input Pending) until the variable is input by the user.</p>
Syntax	IV <user variable/R1-R4>
Usage	Program/Immediate
Code Example	<pre>IV R1 'Input data into R1 VA K5 'Create user variable K5 IV K5 'Input data into user variable K5 IV R1 'input value into register 1 LB k1 'label program loop k1 BR k1,If=1 'branch to k1 awaiting user input</pre>
Related	IF

JE (Jog enable)

Compatible with Motion Control products:
 MDrive
 MDrive (Plus² expanded features)
 MDrive (Ethernet)
 MDrive Hybrid
 MDrive Hybrid (Ethernet)
 MForce
 MForce (Plus² expanded features)

Mnemonic	JE				
Function	Enable/disable jog functions				
Type	Flag				
Description	This command will enable Jog Mode if I/O are set for Jog Plus and/or Jog Minus.				
Syntax	JE=<0/1>				
States	<table border="0"> <tr> <td>0</td> <td>Jog functions disabled</td> </tr> <tr> <td>1</td> <td>Jog functions enabled</td> </tr> </table>	0	Jog functions disabled	1	Jog functions enabled
0	Jog functions disabled				
1	Jog functions enabled				
Default	0				
Usage	Program/Immediate, Read/Write				
Code Example	<pre>JE=0 'Disable Jog mode JE=1 'Enable Jog mode</pre>				

L (List program space)

Compatible with Motion Control products:
 MDrive
 MDrive (Plus² expanded features)
 MDrive (Ethernet)
 MDrive Hybrid
 MDrive Hybrid (Ethernet)
 MForce
 MForce (Plus² expanded features)

Mnemonic	L
Function	List contents of program space
Type	Instruction
Description	The L instruction will print the contents of program space beginning at the specified address to the end. If no address is specified it will list beginning at address 1.
Syntax	L <address/label>
Usage	Immediate
Code Example	L 'List program space contents from address 1 L G5 'List program space contents from label G5
Related	CP, FD

LB (Label program or subroutine)

Compatible with Motion Control products:
 MDrive
 MDrive (Plus² expanded features)
 MDrive (Ethernet)
 MDrive Hybrid
 MDrive Hybrid (Ethernet)
 MForce
 MForce (Plus² expanded features)

Mnemonic	LB
Function	Label program or subroutine
Type	Instruction
Description	The LB, or Label Instruction, allows the user to assign a 2 character name to a program, (BR) branch process or (CL) call subroutine. There is a limit of 192 labels. The restrictions for this command are: <ol style="list-style-type: none"> 1. A label cannot be named after an MCode Instruction, Variable or Flag or Keyword. 2. The first character must be alpha, the second character may be alpha-numeric. 3. A label is limited to two characters. 4. A program labeled SU will run on power-up 5. Labels ARE NOT case sensitive.
Syntax	LB <label>
Usage	Program
Code Example	PG 100 'Start Program at address 100 LB G1 'Name program G1 PG 1 LB SU 'Label Program to execute on power up.
Related	BR, CL, EX, TI, TP, L, CP

LD (Lead limits)

Compatible with Motion Control products:
MDrive Hybrid
MDrive Hybrid (Ethernet)

Mnemonic	LD
Function	Set rotor lead limit
Type	Variable
Description	LD will set the lead limit in motor steps.
Syntax	LD=<steps>
Units	steps
Range	0 — 2147483647
Default	102400
Usage	Program/Immediate, Read/Write
Code Example	<code>LD=52100 `set lead limit to 52100</code>
Notes	When the lead limit is reached, error 106, lead limit reached will be active
Related	LG, LL

LG (Lag limits)

Compatible with Motion Control products:
MDrive Hybrid
MDrive Hybrid (Ethernet)

Mnemonic	LG
Function	Set rotor lag limit
Type	Variable
Description	LD will set the lag limit in motor steps.
Syntax	LG=<steps>
Units	steps
Range	0 — 2147483647
Default	102400
Usage	Program/Immediate, Read/Write
Code Example	<code>LG=52100 `set lag limit to 52100</code>
Notes	When the lag limit is reached, error 107, lag limit reached will be active
Related	LD, LL

LL (Position lead/lag)

Compatible with Motion Control products:
MDrive Hybrid
MDrive Hybrid (Ethernet)

Mnemonic	LL
Function	Read rotor lead/lag
Type	Variable
Description	<p>Represent the number of counts that the rotor leads or lags the stator.</p> <p>A positive value indicates position lag. A negative value indicates position lead</p>
Syntax	<pre>PR LL CL <address/label>, LL <condition><steps> BR <address/label>, LL <condition><steps></pre>
Units	steps
Range	-2147483647 to +2147483647
Usage	Program/Immediate, Read only
Code Example	<pre>PR LL `read rotor lead/lag CL k5, LL>102500 `Call subroutine k5 if `LL is greater than `102500 steps</pre>
Related	LD, LG

LK (Lock user program)

Compatible with Motion Control products:
MDrive
MDrive (Plus² expanded features)
MDrive (Ethernet)
MDrive Hybrid
MDrive Hybrid (Ethernet)
MForce
MForce (Plus² expanded features)

Mnemonic	LK				
Function	Lock access to user program space				
Type	Flag				
Description	<p>This flag allows the user to lock the program from being listed or modified. It can only be reset by clearing the entire program space: CP (no address). If CP (address/label), L (address/label) or PG (address/label) are entered, then error 44 (Program Locked) will be set and nothing else will happen.</p> <p>To clear LK, don't save (S) then do a Ctrl-C or Cycle Power and the LK will be reset to previous unlocked state. (Program is automatically stored in NVM as it is entered.) Or you may clear program (CP or FD to list or reprogram the device.). This will clear the program and reset LK to 0</p>				
Syntax	LK=<0/1>				
States	<table border="0"> <tr> <td>0</td> <td>User programs may be modified or listed</td> </tr> <tr> <td>1</td> <td>User programs may not be modified or listed</td> </tr> </table>	0	User programs may be modified or listed	1	User programs may not be modified or listed
0	User programs may be modified or listed				
1	User programs may not be modified or listed				
Default	0 (disabled)_				
Usage	Immediate, Read/Write				
Code Example	LK=1 `Lock programs from being listed or changed				

LM (Limit stop modes)

Compatible with Motion Control products:
 MDrive
 MDrive (Plus² expanded features)
 MDrive (Ethernet)
 MDrive Hybrid
 MDrive Hybrid (Ethernet)
 MForce
 MForce (Plus² expanded features)

Mnemonic	LM
Function	Limit stop modes
Type	Variable
Description	The LM variable specifies the Limit Stop Mode for the MCode compatible device. There are six LM modes.
Syntax	LM=<mode>
Range	1 - 6
Modes	<p>1 Normal Limit function with a decel ramp. The I/O must be set for Limits (S1-S4, S9-S12 Command). If the limit switch in the direction of travel is reached, the motion will decel to a stop. That is, the plus limit works only in the plus direction of travel and the minus limit works only in the minus direction of travel. In Figure 5.2, the Limit is activated at a given position but because of the deceleration rate the motion continues for the duration of the deceleration time. This position may be beyond the trip point of the limit and a subsequent move in the same direction will not stop. A crash may be imminent. If the limit is activated and maintained the software will allow motion only in the opposite direction. If Homing (HM) is active and a limit is reached, the motion will decel to a stop and then reverse direction and seek the Homing Switch. If the Homing Switch is not activated on the reverse and the opposite limit is reached all motion will stop with a decel ramp. (See HM)</p> <p>2 A Limit stops all motion with a deceleration ramp but no Homing.</p> <p>3 A Limit will stop all motion with a deceleration ramp and stop program execution.</p> <p>4 Functions as LM=1 but with no deceleration ramp</p> <p>5 Functions as LM=2 but with no deceleration ramp.</p> <p>6 Functions as LM=3 but with no deceleration ramp.</p>
Usage	Program/Immediate, Read/Write
Code Example	LM=2 'Set Limit stop with a decel ramp, no homing.
Related	H,I, HM, JE, MA, MR, SL

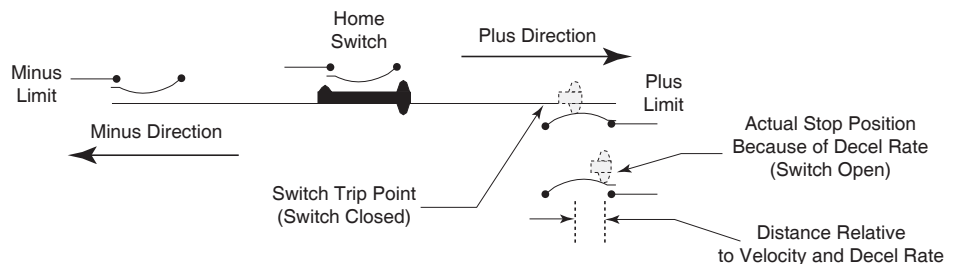

Figure 5.2 Limit modes of operation

LR (Locked rotor)

Compatible with Motion Control products:
MDrive Hybrid
MDrive Hybrid (Ethernet)

A locked rotor is defined as no rotor movement while at the maximum allowed lag for a specified period of time. When lag becomes equal to the bounds, a timer starts to count down. Upon reaching zero, a locked rotor will be indicated by the assertion of a status flag. The timer reloads on any encoder movement. The timer timeout period is user selectable from 2mS to 65.5 seconds.

When Hybrid is configured AS=1 or 2, a locked rotor will also cause an internal fault (LR) disabling the output bridge. The bridges may be re-enabled by cycling power, cycling the enable input, or via software command.

In torque mode, a locked rotor does not disable the bridges. The locked rotor flag (LR) can be used to indicate the rotor has been stopped at the specified torque for a preset amount of time.

Mnemonic	LR
Function	Locked rotor
Type	Read only status flag
Description	Indicates the state of the rotor as locked (1) or unlocked (0).
Syntax	PR LR
Range	0/1
Usage	Program/Immediate, Read only
Code Example	<pre>PR LR 'read rotor lead/lag TA 2,k3 'trip to sub k3 on locked rotor</pre>
Related	LT, TA

LT (Locked rotor timeout)

Compatible with Motion Control products:
MDrive Hybrid
MDrive Hybrid (Ethernet)

Mnemonic	LT
Function	Set locked rotor timeout
Type	Variable
Description	The LT variable will set the locked rotor timeout in milliseconds. This setting will determine the time in milliseconds that the output bridge will disable following the locked rotor (LR) flag being active.
Syntax	LT=<time>
Units	Milliseconds
Range	2 — 65535
Default	2000 mS
Usage	Program/Immediate, Read/Write
Code Example	<pre>LT=1000 'set locked rotor time to 1S</pre>
Notes	The output bridge will not disable if the Hybrid is in torque mode (AS=3)
Related	AS, CB, LR

MA (Move to an absolute position)

Compatible with Motion Control products:
 MDrive
 MDrive (Plus² expanded features)
 MDrive (Ethernet)
 MDrive Hybrid
 MDrive Hybrid (Ethernet)
 MForce
 MForce (Plus² expanded features)

Mnemonic	MA
Function	Move to an absolute position
Type	Instruction
Description	<p>Set mode for absolute move and move to an absolute position relative to (0) zero. MD (Motion Mode) will be set to MA. The time required to calculate the move is 2.5 mSec.</p> <p>MA command will not operate during a homing sequence.</p> <p>An in progress MA can be stopped with an "esc" entry or an SL 0 command.</p>
Syntax	MA <±position>,<parameter 2>, <parameter 3>
Parameter 2	<p>0 (or blank) no action taken</p> <p>1 Device name will be sent out of the serial port on move completion.</p>
Parameter 3	<p>0 (or blank) no action taken.</p> <p>1 Motor will continue moving after reaching position.</p>
Usage	Program/Immediate
Code Example	<pre>MA 200000 'Move to absolute position 200000 MA 100000,1 'Move to abs. pos. 100000, send DN when 'complete MA 512000,0,1 'Move to abs. pos. 512000, continue 'motion after position is reached.</pre>
Related	MD, MR, MS, P, SL

MD (Motion mode)

Compatible with Motion Control products:
 MDrive
 MDrive (Plus² expanded features)
 MDrive (Ethernet)
 MDrive Hybrid
 MDrive Hybrid (Ethernet)
 MForce
 MForce (Plus² expanded features)

Mnemonic	MD
Function	Motion mode
Type	Variable
Description	<p>Indicates what the last motion command was. When just a number is entered, then it will execute the move type according to the previous move type entered. This allows the user to apply numeric data to the last motion command without having to enter the command itself.</p>
Syntax	PR MD
Units	Motor steps/Encoder counts
Usage	Program/Immediate. Read
Code Example	<pre>PR MD 'Return the last motion command used to the 'terminal screen. Response will be the last 'motion command ie. MR MR 10000 'Move Relative 10000 steps 5000 'Motor will move relative 5000 steps</pre>
Notes	Note that if the IF flag is pending, numeric entry will be applied to the IV (Input Variable).
Related	MA, MR, MS, P, PR, SL

MF (Make up frequency)

Compatible with Motion Control products:
MDrive Hybrid
MDrive Hybrid (Ethernet)

Mnemonic	MF
Function	Set make up frequency
Type	Variable
Description	Defines the frequency at which missed steps are re-inserted into the move profile.
Syntax	MF=<frequency>
Units	Hz
Range	306 — 5000000
Default	768000 Hz
Usage	Program/Immediate, Read/Write
Code Example	MF=256000 `set make up freq to 25.6 kHz
Notes	MF will be used for make up if MU=1
Related	MU, SS

MP (Moving to position)

Compatible with Motion Control products:
MDrive
MDrive (Plus² expanded features)
MDrive (Ethernet)
MDrive Hybrid
MDrive Hybrid (Ethernet)
MForce
MForce (Plus² expanded features)

Mnemonic	MP
Function	Moving to position
Type	Flag
Description	This flag will=1 when the axis is moving to a position following a MA or MR instruction until MT expires..
Syntax	PR MP
Range	0/1
Status Response	0 Not moving 1 Moving to a position
Usage	Program/Immediate, Read
Code Example	PR MP `read the state of the MP flag to terminal
Related	MT

MR (Move to a relative position)

Compatible with Motion Control products:
 MDrive
 MDrive (Plus² expanded features)
 MDrive (Ethernet)
 MDrive Hybrid
 MDrive Hybrid (Ethernet)
 MForce
 MForce (Plus² expanded features)

Mnemonic	MR
Function	Move to a relative position
Type	Instruction
Description	<p>Set mode for relative move and move a relative distance. MD (Motion Mode) will be set to MR. The time required to calculate the move is 2.5 mSec.</p> <p>MR command will not operate during a homing sequence.</p> <p>An in progress MR can be stopped with an "esc" entry or an SL 0 command.</p>
Syntax	MR <±position>,<parameter 2>, <parameter 3>
Parameter 2	<p>0 (or blank) no action taken</p> <p>1 Device name will be sent out of the serial port on move completion.</p>
Parameter 3	<p>0 (or blank) no action taken.</p> <p>1 Motor will continue moving after reaching position.</p>
Usage	Program/Immediate
Code Example	<pre>MR 200000 'Move to relative position 200000 MR 100000,1 'Move to rel. pos. 100000, send DN when 'complete MR 512000,0,1 'Move to rel. pos. 512000, continue 'motion after position is reached.</pre>
Related	MD, MR, MS, P, SL

MT (Motor settling delay time)

Compatible with Motion Control products:
 MDrive
 MDrive (Plus² expanded features)
 MDrive (Ethernet)
 MDrive Hybrid
 MDrive Hybrid (Ethernet)
 MForce
 MForce (Plus² expanded features)

Mnemonic	MT
Function	Motor settling delay time
Type	Variable
Description	Specifies the motor settling delay time in milliseconds. MT allows the motor to settle following a move. This is the time between moves if consecutive motions are executed. the MV flag will be active during this time.
Syntax	PR MT
Units	Milliseconds
Range	0 to 65000
Default	0
Usage	Program/Immediate. Read/Write
Code Example	MT=50 `Set motor settling delay time to 50 milliseconds
Notes	<p>MT is added into HT (Hold Current Delay Time). The total of the two cannot exceed 65535. Thus the maximum setting for $MT=(65535-HT)$.</p> <p>MT should be at least 50 mS when Encoder function is enabled (EE=1)</p>
Related	HC, HT, RC

MU (Make up mode)

Compatible with Motion Control products:
MDrive Hybrid
MDrive Hybrid (Ethernet)

Automatic position maintenance can be enabled which will insert steps as required, when conditions allow, in the appropriate direction to bring the position difference between the commanded number of steps and actual steps taken to zero. The speed of position maintenance can be performed at one (1) of two (2) speeds as specified by the make up (MU) variable. Insertion can be at a specified speed or can be set at the maximum speed the load will allow. There is no acceleration or deceleration applied to position make up, therefore make up could be abrupt at high speed.

Mnemonic	MU
Function	Set make up mode
Type	Variable
Description	Determines the mode for position maintenance
Syntax	MU=<mode>,<parameter>
Range	0 — 2
Modes	0 Off 1 Use make up frequency (MF) as make up frequency 2 Use system speed (SS) as make up frequency
Parameters	0 Use lead/lag (LL) 1 Clear lead/lag (LL)
Default	0 (Off)
Usage	Program/Immediate, Read/Write
Code Example	MU=2,1 'use SS, clear LL
Notes	The make up parameter is not saved. Position maintenance will only occur when motor lag/lead is within 1.1 motor steps. Make up steps may be interleaved with motion steps and made after a move has completed. Where position maintenance occurs is dependant on motor lag/lead, motion frequency and selected make up speed. Make up mode will be cleared when bridges are disabled and Hybrid is enabled.
Related	MF, SS

MV (Moving)

Compatible with Motion Control products:
MDrive
MDrive (Plus² expanded features)
MDrive (Ethernet)
MDrive Hybrid
MDrive Hybrid (Ethernet)
MForce
MForce (Plus² expanded features)

Mnemonic	MV
Function	Axis in motion
Type	Flag
Description	Moving flag will be in a logic 1 state when a motion is occurring. This flag will set an output ACTIVE if S<1-4, 9-12>=17
Syntax	PR MV
Range	0/1
Status Response	0 Not moving 1 Moving
Usage	Program/Immediate, Read
Code Example	PR MV 'read the state of the MV flag to terminal
Related	VC, S1-S4, S9-S12

NE (Numeric enable)

Compatible with Motion Control products:
 MDrive
 MDrive (Plus² expanded features)
 MDrive (Ethernet)
 MDrive Hybrid
 MDrive Hybrid (Ethernet)
 MForce
 MForce (Plus² expanded features)

Mnemonic	NE
Function	Numeric enable flag
Type	Flag
Description	Numeric enable flag will enable (default) or disable the ability of the device to execute the last motion command upon the entry of a numeric value without the preceding command being entered. By default, if a motion command is executed i.e. MR 20000, when the user enters -20000, the device will move relative -20000. If disabled, the user must enter a motion command to execute a move, i.e. MA 100000, MR -50000, SL 300000 etc.
Syntax	NE=<1/0>
Range	0/1
Default	1 (enabled)
Status Response	0 Disabled 1 Enabled (Default)
Usage	Program/Immediate, Read/Write
Code Example	NE=0 `disable motion mode on numeric entry
Related	MA, MR, SL

O1, O2, O3 and O4 (Set outputs 1, 2 ,3 or 4)

Compatible with Motion Control products:
 MDrive
 MDrive (Plus² expanded features)
 MDrive (Ethernet)
 MDrive Hybrid
 MDrive Hybrid (Ethernet)
 MForce
 MForce (Plus² expanded features)

Mnemonic	O1 - O4
Function	Set output logic state
Type	Variable
Description	This variable will set the logic state of the specified output to 1 or 0. The voltage level will be dependant on the active (low/high) state of the output, specified by the S<1-4> variable.
Syntax	Syntax:O<1-4>=<0/1>
Units	Logic 0 or 1
Range	0/1
Usage	Program/Immediate. Write
Code Example	O2=1 `Set output 2 ACTIVE
Related	O9-O12, OL, OH, OT, S1-S4

O9, O10, O11 and O12 (Set outputs 9, 10, 11 or 12)

Compatible with Motion Control products:
 MDrive
 MDrive (Plus² expanded features)
 MDrive (Ethernet)
 MDrive Hybrid
 MForce
 MForce (Plus² expanded features)

Mnemonic	O9 - O12
Function	Set output logic state
Type	Variable
Description	This variable will set the logic state of the specified output to 1 or 0. The voltage level will be dependant on the active (low/high) state of the output, specified by the S<1-4> variable.
Syntax	O<9-12>=<0/1>
Units	Logic 0 or 1
Range	0/1
Usage	Program/Immediate. Write
Code Example	O10=1 `Set output 10 ACTIVE
Related	O1-O4, OL, OH, OT, S1-S4

OE (On error handler)

Compatible with Motion Control products:
 MDrive
 MDrive (Plus² expanded features)
 MDrive (Ethernet)
 MDrive Hybrid
 MDrive Hybrid (Ethernet)
 MForce
 MForce (Plus² expanded features)

Mnemonic	OE
Function	On error handler
Type	Instruction
Description	When an error occurs, the specified subroutine is called. If a program was running when the fault occurs, once the error routine completes, program execution continues with the instruction after the one that caused the error. After OE, the command is executed. A program need not be running for the subroutine specified by OE to run. The ON ERROR function is disabled by setting the address parameter to 0 or resetting the device with an FD or CP OE Subroutine MUST have an RT at the end. OE will not execute during programming.
Usage	Program
Code Example	OE K1 `run subroutine K1 on an error
Related	EF, ER

OL (Set outputs 1 - 4 as a group)

Compatible with Motion Control products:
 MDrive
 MDrive (Plus² expanded features)
 MDrive Hybrid
 MForce
 MForce (Plus² expanded features)

Mnemonic	OL
Function	Set the state of outputs 1 - 4 as one value
Type	Variable
Description	The OL variable allows the user to set Outputs 1-4 as one 4 bit binary value. The value is entered in decimal, with a range of 0-15 in binary where Output 1 will be the LSb and Output 4 will be the MSb.
Syntax	OL=<0-15>
Units	Decimal
Range	0 —15
Usage	Program/Immediate. Write
Code Example	OL=13 `set output group 1-4 to 1101
Related	IH, IN, IL, OH, OT, S1-S4

OH (Set outputs 9 - 12 as a group)

Compatible with Motion Control products:
 MDrive (Plus² expanded features)
 MDrive Hybrid
 MForce (Plus² expanded features)

Mnemonic	OH
Function	Set the state of outputs 9 - 12 as one value
Type	Variable
Description	The OH variable allows the user to set Outputs 9-12 as one 4 bit binary value. The value is entered in decimal, with a range of 0-15 in binary where Output 9 will be the LSb and Output 12 will be the MSb.
Syntax	OH=<0-15>
Units	Decimal
Range	0 —15
Usage	Program/Immediate. Write
Code Example	OH=13 `set output group 9-12 to 1101
Related	IH, IN, IL, OL, OT, S9-S12

OT (Set outputs 1- 4 and 9 - 12 as a group)

Compatible with Motion Control products:
 MDrive
 MDrive (Plus² expanded features)
 MDrive Hybrid
 MForce
 MForce (Plus² expanded features)

Mnemonic	OT
Function	Set the state of outputs 1 - 4 and 9 - 12 as one value
Type	Variable
Description	The OT variable allows the user to set Outputs 1-4 and 9-12 as one 8 bit binary value. The value is entered in decimal, with a range of 0-255 in binary where Output 1 will be the LSb and Output 12 will be the MSb.
Syntax	OH=<0-255>
Units	Decimal
Range	0 — 255
Usage	Program/Immediate. Write
Code Example	<code>OT=214 `set the standard output group to 11010110</code>
Notes	NOTE: On Standard Plus Models OT will only set the lower group (Outputs 1-4)
Related	IL, IH, IN, OL, OH, S1-S4, S9-S12

P (Position counter)

Compatible with Motion Control products:
 MDrive
 MDrive (Plus² expanded features)
 MDrive (Ethernet)
 MDrive Hybrid
 MDrive Hybrid (Ethernet)
 MForce
 MForce (Plus² expanded features)

Mnemonic	P
Function	Position counter
Type	Variable
Description	This instruction is used to set or print the value of the MCode compatible device position counter. The position will read in Motor Steps from C1 (Counter 1) by default, if encoder functions are enabled, the position counter will read in Encoder Counts from C2 (Counter 2). Modifying P in essence changes the frame of reference for the axis for Move Absolute (MA) instructions. P will probably be set once during system set up to reference or "home" the system.
Syntax	P=<±position>, PR P
Units	Motor Steps (EE=0)/Encoder Counts (EE=1)
Range	-2147483648 to +2147483647
Default	0
Usage	Program/Immediate. Read/Write
Code Example	<code>PR P `sprint the position to the terminal window</code>
Related	C1, C2

PC (Position capture at trip)

Compatible with Motion Control products:
 MDrive (Plus² expanded features)
 MDrive (Ethernet)
 MDrive Hybrid
 MDrive Hybrid (Ethernet)
 MForce (Plus² expanded features)

Mnemonic	PC
Function	Position capture at trip
Type	Instruction
Description	Captures motor or encoder position during a trip event. Activation will occur upon any trip function EXCEPT a position trip (TP). Will display in either motor steps (EE=0) or encoder counts (EE=1)
Syntax	PR PC
Usage	Immediate
Code Example	PR PC 'Display captured position
Related	TE, TI, TC, TT, S13

PG (Program mode)

Compatible with Motion Control products:
 MDrive
 MDrive (Plus² expanded features)
 MDrive (Ethernet)
 MDrive Hybrid
 MDrive Hybrid (Ethernet)
 MForce
 MForce (Plus² expanded features)

Mnemonic	PG
Function	Enter/exit program mode
Type	Instruction
Description	This instruction toggles the device into or out of program mode.
Syntax	PG <address>
Usage	Immediate/Program
Code Example	PG 100 'enter program at address 100 'program body ... PG 'end program return to immediate mode
Related	CP

PM (Position maintenance enable)

Compatible with Motion Control products:
 MDrive
 MDrive (Plus² expanded features)
 MDrive (Ethernet)
 MForce
 MForce (Plus² expanded features)

Mnemonic	PM
Function	Position maintenance enable
Type	Flag
Description	<p>This flag will enable the position maintenance functions of an MCode compatible device with encoder. The position maintenance velocity will be at the setting for VI (Initial Velocity). If moved beyond the value of DB (DeadBand), unit will correct</p> <p>If SM = 0 and PM = 1, Position Maintenance will take place provided the position does not exceed the Stall Factor (SF).</p> <p>If SM = 1 and PM = 1, Position Maintenance will take place even if the Stall Factor (SF) is exceeded, unless VI is set too high causing the motor to stall.</p>
Syntax	PM=<1/0>
Range	0/1
Default	1 (enabled)
Status Response	0 Disabled (Default) 1 Enabled
Usage	Program/Immediate, Read/Write
Code Example	PM=1 `Enable position maintenance`
Related	VI, EE, SM, DB, C2, SF

PN (Part number)

Compatible with Motion Control products:
 MDrive
 MDrive (Plus² expanded features)
 MDrive (Ethernet)
 MDrive Hybrid
 MDrive Hybrid (Ethernet)
 MForce
 MForce (Plus² expanded features)

Mnemonic	PN
Function	Read device part number
Type	Variable
Syntax	PR PN
Usage	Immediate, Read
Code Example	PR PN `read the device part number`

PR (Print specified data or text)

Compatible with Motion Control products:
 MDrive
 MDrive (Plus² expanded features)
 MDrive (Ethernet)
 MDrive Hybrid
 MDrive Hybrid (Ethernet)
 MForce
 MForce (Plus² expanded features)

Mnemonic	PR
Function	Print specified data or text
Type	Instruction
Description	<p>This instruction is used to output text and parameter value(s) to the host PC. Text should be enclosed in quotation marks while parameters (variables and flags) should not. Text strings and parameters which are to be output by the same PR instruction should be separated by commas. The information being output is followed by a carriage return unless a semicolon (;) is included at the end of the PR instruction to indicate that the cursor should remain on the same line.</p> <p>It is important to note that the receive buffer for the MCode device is 64 characters, this includes the PR instruction itself, any spaces, text characters, etc. If the buffer length is exceeded a CR/LF will occur and set error 20.</p>
Syntax	PR <text>, <data>
Usage	Immediate
Code Example	<pre>PR "Position =", P 'print axis position PR MS 'Print the µStep Resolution setting</pre>
Notes	A delay time between the print requests to the device must be considered to allow the device time to interpret a command and answer the host before a subsequent command can be sent.

PS (Pause program execution)

Compatible with Motion Control products:
 MDrive
 MDrive (Plus² expanded features)
 MDrive (Ethernet)
 MDrive Hybrid
 MDrive Hybrid (Ethernet)
 MForce
 MForce (Plus² expanded features)

Mnemonic	PS
Function	Pause program execution
Type	Instruction
Description	<p>This instruction is used to pause an executing program and invoke normal deceleration of any motion being executed to Zero. Immediate mode instructions are allowed while a program is in a paused state. To resume the program the RS instruction is used.</p>
Syntax	PS
Usage	Immediate
Code Example	<pre>PS 'Pause running program</pre>
Related	RS, SL, MA, MR, HI, HM

PW (PWM configuration)

Compatible with Motion Control products:
MForce
MForce (Plus² expanded features)

⚠ CAUTION

This variable is only applicable to the MForce Product Line and is used to tune the PWM Settings to optimize the current control of the MForce Driver. It should not be used unless erratic motion or positional accuracy problems are being experienced.

Note that there are other factors that could contribute to these problems. Ensure that all wiring conforms to the guidelines in the MForce Hardware Manual.

Be aware that this parameter, when used with the checksum will write to the boot sector of memory. This sector only allows eight write cycles. Ensure that the settings you choose are optimal prior to storing the parameter to the boot.

Read this section closely before making changes to the PWM settings. Please contact application support for questions concerning the use of this command.

Mnemonic	PW
Function	PWM configuration
Type	Variable
Description	<p>The PW variable is only used on the MForce product line. It is not a reserved word on the MDrive product line and may be used as a User Variable or Label.</p> <p>This variable is used to set the PWM Current Control settings of the MForce ONLY! It does not apply in any function to the MDrive series and may be used as a label or user variable or flag.</p> <p>See Appendix G of this document for parameter settings and usage. It is recommended that these settings not be modified from the factory default unless the motor exhibits rough motion, audible noise or poor zero-crossing performance. If these symptoms exist, please check for other issues such as electrical noise coupled onto logic signals or ground loops before modifying these settings.</p>
Syntax	<p>PW=<mask>,<period>,<sfreq>, <chksum></p> <p>PR PW (Response = <mask>,<period>,<sfreq>,<boot_writes_remaining></p>
Units	Vary
Range	See tables in Section 7.4: MForce PWM Settings, of this document.
Default	204,95,170
Usage	Immediate. Read/Write

PY (Party mode enable)

Compatible with Motion Control products:
 MDrive
 MDrive (Plus² expanded features)
 MDrive Hybrid
 MForce
 MForce (Plus² expanded features)

Mnemonic	PY
Function	Party mode enable
Type	Flag
Description	<p>The party flag must be set to 1 if the device is being used in a multidrop communication system.</p> <p>When Party Mode is enabled, each device in the system must be addressed by the host computer by using the device name specified by the DN instruction. This name will precede any command given to a specified unit in the system and be terminated with a Control J (CTRL + J). One CTRL + J must be issued after power up or entering the Party Mode to activate the Party Mode. By default the DN assigned at the factory is the exclamation character (!) .</p> <p>The global Drive Name is the asterisk character (*). Commands preceded by this character will be recognized by every MCode compatible device in the system.</p> <p>After the Party Mode is enabled, send CTRL + J (^J) to activate it. Type commands with Device Name (DN) and use CTRL + J as the Terminator.</p>
Syntax	PY=<0/1>
Range	0/1
Default	0 (disabled)
Status	0 Disabled (Default) 1 Enabled
Usage	Program/Immediate, Read/Write
Code Example	PY=1 'Enable Party Mode Communications
Notes	Note: A delay time between the command requests to the device must be considered to allow the device time to interpret a command and answer the host before a subsequent command can be sent. The time between requests is dependent on the command and the corresponding response from the Device.
Related	DN, DG

QD (Queued)

Compatible with Motion Control products:
 MDrive
 MDrive (Plus² expanded features)
 MDrive Hybrid
 MForce
 MForce (Plus² expanded features)

Mnemonic	QD
Function	Queued
Type	Flag
Description	Function is to queue drives on party lines. Works similar to uLynx QUED flag. If a drive or drives are Queued, then, when they see the address “^”, they will respond to it. All other, non-queued drives will ignore the command
Syntax	QD=<0/1>
Range	0/1
Default	0 (disabled)
Status	0 Disabled (Default) 1 Enabled
Usage	Immediate, Read/Write
Code Example	QD=1 `Queue Drive
Related	PY, DN

R1, R2, R3 and R4 (User registers)

Compatible with Motion Control products:
 MDrive
 MDrive (Plus² expanded features)
 MDrive (Ethernet)
 MDrive Hybrid
 MDrive Hybrid (Ethernet)
 MForce
 MForce (Plus² expanded features)

Mnemonic	R1 - R4
Function	User registers
Type	Variable
Description	The MCode compatible device has four 32 bit user registers to contain numerical data. These registers may contain up to 11 digits including the sign and may be used to store and retrieve data to set variables, perform math functions, store and retrieve moves and set conditions for branches and call subroutine.
Syntax	R<1-4>=<number>
Range	-2147483647 to 2147483647
Usage	Immediate, Read/Write
Code Example	R1=50000 `Set Register 1 to 50000 R2=Q2 `Set Reg. 2 to the value of User Variable Q2

RC (Motor run current)

Compatible with Motion Control products:
 MDrive
 MDrive (Plus² expanded features)
 MDrive (Ethernet)
 MDrive Hybrid
 MDrive Hybrid (Ethernet)
 MForce
 MForce (Plus² expanded features)

Mnemonic	RC			
Function	Motor run current			
Type	Variable			
Description	This variable defines the motor run current in percent.			
	HC=(%)	MDrive MDrive Hybrid (All)	MForce MicroDrive (A RMS)	MForce PowerDrive (A RMS)
	10	MDrive Range 0 To 100%	0.3	0.5
	20		0.6	1.0
	30		0.9	1.5
	40	Actual Current	1.2	2.0
	50	Not required as Motor is	1.5	2.5
	60	appropriately	1.8*	3.0
	70	sized to the	2.1*	3.5
	80	device.	2.4*	4.0
	90		2.7*	4.5
	100		3.0*	5.0
	*Older versions of the MForce MicroDrive would output 2.0 A RMS. For these drives 67% run current will output 2.0 A. The 3.0 A MicroDrives are marked 3.0 Amps on the label.			
Syntax	RC= <percent>			
Units	Percent			
Range	1 to 100			
Default	25%			
Usage	Program/Immediate			
Code Example	RC=50 'set run current to 50%			
Related	HC			

RS (Resume program execution)

Compatible with Motion Control products:
 MDrive
 MDrive (Plus² expanded features)
 MDrive Hybrid
 MForce
 MForce (Plus² expanded features)

Mnemonic	RS		
Function	Resume program execution		
Type	Instruction		
Description	This instruction is used to resume a program that has been paused using the PS instruction. Any move that was paused will resume as well. Motion will resume using the normal acceleration profiles.		
Syntax	RS		
Usage	Immediate		
Code Example	RS 'Resume paused program		
Related	PS, SL, MA, MR, HI, HM		

RT (Return from subroutine)

Compatible with Motion Control products:
 MDrive
 MDrive (Plus² expanded features)
 MDrive (Ethernet)
 MDrive Hybrid
 MDrive Hybrid (Ethernet)
 MForce
 MForce (Plus² expanded features)

Mnemonic	RT
Function	Return from called or on-error subroutine
Type	Instruction
Description	This instruction defines the end of a subroutine. This instruction is required and will be the final instruction in the subroutine executed by the CL or OE instruction. When used, it will return to the program address immediately following the instruction which executed the subroutine.
Syntax	RT
Usage	Program
Code Example	<pre>CL K8 `Call Subroutine K8 LB K8 *****SUBROUTINE K8***** RT `Go back to main program</pre>
Related	CL, OE

S (Save to NVM)

Compatible with Motion Control products:
 MDrive
 MDrive (Plus² expanded features)
 MDrive (Ethernet)
 MDrive Hybrid
 MDrive Hybrid (Ethernet)
 MForce
 MForce (Plus² expanded features)

Mnemonic	S
Function	Save to NVM
Type	Instruction
Description	<p>Saves all variables and flags currently in working memory (RAM) to nonvolatile memory (NVM). The previous values in NVM are completely overwritten with the new values.</p> <p>When the user modifies variables and flags, they are changed in working memory (RAM) only. If the S instruction is not executed before power is removed from the control module, all modifications to variables & flags since the last S will be lost.</p>
Syntax	S
Usage	Program/Immediate
Code Example	<pre>S `Save all variable and flag states to NVM</pre>
Notes	<p>Note: Communications during a Save could corrupt communications. If a Save is performed during the execution of a motion command, trips may be delayed.</p> <p>Use of the S command during a move (MA or MR) will generate an error 73, the save will not occur.</p>

S1, S2, S3, S4, S9, S10, S11, S12 (Setup I/O points 1 - 4 & 9 - 12)

Compatible with Motion Control products:

S1 - S4

- MDrive
- MDrive (Plus² expanded features)
- MDrive (Ethernet)
- MDrive Hybrid
- MDrive Hybrid (Ethernet)
- MForce
- MForce (Plus² expanded features)

S9 - S12

- MDrive (Plus² expanded features)
- MDrive (Ethernet)
- MDrive Hybrid
- MForce (Plus² expanded features)

Mnemonic	S1 - S4, S9 - S12																				
Function	Set up I/O point																				
Type	Instruction																				
Description	<p>This instruction is used to setup the I/O type and active states, and sink/source setting. Each of the device I/O points may be programmed as either general purpose inputs and outputs, or to dedicated input function or dedicated output function.</p> <p>When programmed as inputs, these points can be sinking or sourcing, and may be programmed such that they are active when pulled to ground, or active when left floating. By default each point is configured as a general purpose input, active when LOW.</p> <p>When configured as outputs on devices with Plus² expanded features the outputs may be sinking or sourcing. For standard MDrive and MForce devices the outputs are sinking only.</p> <p>There are three parameters attached to this instruction:</p> <ol style="list-style-type: none"> 1. The type specifies the function of the I/O point (see tables - following page). 2. The second parameter sets the active state, which defines the point as (0 - Default) LOW or (1) HIGH ACTIVE. 3. The third parameter specifies whether the point will be (0 - Default) sinking or sourcing (1). 																				
Syntax	S<point number>=<type>,<0/1>,<0/1>																				
Input Types	<table border="1"> <tr> <td>0</td> <td>General purpose input</td> </tr> <tr> <td>1</td> <td>Homing function, will function as specified by the homing command (HM).</td> </tr> <tr> <td>2</td> <td>Limit +, will function as specified by the limit command (LM).</td> </tr> <tr> <td>3</td> <td>Limit —, will function as specified by the limit command (LM).</td> </tr> <tr> <td>4</td> <td>G0 input, will run program at address 1 upon activation.</td> </tr> <tr> <td>5</td> <td>Soft stop, stops motion with deceleration and halts program execution. If program is paused (PS), input is ignored.</td> </tr> <tr> <td>6</td> <td>Pause, pause/resume program with motion</td> </tr> <tr> <td>7</td> <td>Jog +, Will Jog motor in the positive direction at Max. Velocity (VM). The Jog Enable (JE) Flag must be set for this to function.</td> </tr> <tr> <td>8</td> <td>Jog —, Will Jog motor in thenegative direction at max. velocity (VM). The jog enable (JE) flag must be set for this to function.</td> </tr> <tr> <td>11</td> <td>Reset, When set as RESET input, then the action is equivalent to a ^C entered into a terminal. Note: If setting the input to sourcing, active true, ground the input first or a reset will occur.</td> </tr> </table>	0	General purpose input	1	Homing function, will function as specified by the homing command (HM).	2	Limit +, will function as specified by the limit command (LM).	3	Limit —, will function as specified by the limit command (LM).	4	G0 input, will run program at address 1 upon activation.	5	Soft stop, stops motion with deceleration and halts program execution. If program is paused (PS), input is ignored.	6	Pause, pause/resume program with motion	7	Jog +, Will Jog motor in the positive direction at Max. Velocity (VM). The Jog Enable (JE) Flag must be set for this to function.	8	Jog —, Will Jog motor in thenegative direction at max. velocity (VM). The jog enable (JE) flag must be set for this to function.	11	Reset, When set as RESET input, then the action is equivalent to a ^C entered into a terminal. Note: If setting the input to sourcing, active true, ground the input first or a reset will occur.
0	General purpose input																				
1	Homing function, will function as specified by the homing command (HM).																				
2	Limit +, will function as specified by the limit command (LM).																				
3	Limit —, will function as specified by the limit command (LM).																				
4	G0 input, will run program at address 1 upon activation.																				
5	Soft stop, stops motion with deceleration and halts program execution. If program is paused (PS), input is ignored.																				
6	Pause, pause/resume program with motion																				
7	Jog +, Will Jog motor in the positive direction at Max. Velocity (VM). The Jog Enable (JE) Flag must be set for this to function.																				
8	Jog —, Will Jog motor in thenegative direction at max. velocity (VM). The jog enable (JE) flag must be set for this to function.																				
11	Reset, When set as RESET input, then the action is equivalent to a ^C entered into a terminal. Note: If setting the input to sourcing, active true, ground the input first or a reset will occur.																				

Output Types	16	General purpose
	17	Moving, output will be active while the motor is in motion.
	18	Fault, will be active when an error occurs.
	19	Stall, will be in the Active State when a stall is detected. Encoder Required, Stall Detect Mode (SM) must be enabled.
	20	Velocity changing, will be in the Active State when the velocity is changing.
	21	Locked rotor (MDrive Hybrid ONLY).
	23	Moving to position, will be in an active state while moving to an absolute position.
	24	Hybrid active (MDrive Hybrid ONLY).
	25	Make up active (MDrive Hybrid ONLY).
	Parameter 2	0
1		Active when HIGH
Parameter 3	0	Sinking (default)
	1	Sourcing
Default	0 (Off)	
Usage	Program/Immediate, Read/Write	
Code Example	S1=1,0,0 \IO1 to homing input, active LOW, sinking S2=4,1,1 \IO2 = G0 input active HIGH, sourcing S3=17,1,0 \IO3 = moving output, active HIGH, sinking	
Notes	1.	Output Types are SINKING ONLY on Plus devices.
	2.	Once set wait debounce time before using.
Related	I1-4, I9-12, IN, O1-4, O9-12, OT, D1-D4	

Output Circuit Conditions

S1=16,1,0	O1 = 1 (Sink OFF, High Impedance)
Output, Active High, Sinking	O1 = 0 (Sink ON)
S1=16,0,0	O1 = 1 (Sink ON)
Output, Active Low, Sinking	O1 = 0 (Sink OFF, High Impedance)
S1=16,1,1 (Plus ² Only)	O1 = 1 (Source ON)
Output, Active High, Sourcing	O1 = 0 (Source OFF, High Impedance)
S1=16,0,1 (Plus ² Only)	O1 = 1 (Source OFF, High Impedance)
Output, Active Low, Sourcing	O1 = 0 (Source ON)

S5 (Set analog input)

Compatible with Motion Control products:
 MDrive
 MDrive (Plus² expanded features)
 MDrive (Ethernet)
 MDrive Hybrid
 MDrive Hybrid (Ethernet)
 MForce
 MForce (Plus² expanded features)

Mnemonic	S5
Function	Set analog input
Type	Instruction
Description	<p>This I/O point configures the analog input as either a current or voltage input. The value of this input will be read using the I5 instruction, which has a range of 0 to 1023.</p> <p>The first parameter sets the input type as either voltage or current.</p> <p>The second parameter specifies the voltage/current range:</p> <p>Note that for 4 to 20 mA current mode, the range for I5 is 205 to 1023.</p>
1st Parameter	<p>9 Sets the analog input as a voltage input (default).</p> <p>10 Sets the analog input to a current input.</p>
2nd Parameter	<p>0 Sets the input range to 0 to 5 V, or 4 to 20 mA (default).</p> <p>1 Sets the input range to 0 to 10 V, or 0 to 20 mA.</p>
Syntax	S5= <type>, <0/1>
Default	Voltage reference, 0 to +5 VDC
Usage	Program/Immediate, Read/Write
Code Example	<pre>S5=9,0 `Analog Input = voltage, 0-5 VDC S5=9,1 `Analog Input = voltage, 0-10 VDC S5=10,0 `Analog Input = current, 0-20 mA S5=10,1 `Analog Input = current, 4-20 mA</pre>
Related	I5, JE

S7 & S8 (Setup clock I/O points)

Compatible with Motion Control products:
 MDrive (Plus² expanded features)
 MDrive (Ethernet)
 MForce (Plus² expanded features)

Mnemonic	S7 - S8
Function	Set up clock I/O point
Type	Instruction
Description	Sets up I/O 7 and I/O 8 clock type. Can be set as inputs or outputs, I/O 7 and I/O 8 are setup in pairs. The clock types are step clock/direction, up/down, and quadrature.
Syntax	S<7/8>=<type>,<active>
Input Types	<p>Step/Direction , sets I/O 7 and 8 to receive step and direction inputs from an external source. The motion will occur based on the input frequency seen at I/O 7 in the Direction relative to the logic state of I/O 8. The step rate will be based upon the ratio set by Clock Ratio (CR)</p> <p>33</p> <hr/> <p>Quadrature, sets I/O 7 and 8 to receive Channel A and Channel B Quadrature inputs from an external source such as an encoder. The motion will follow the Quadrature Input. The clock rate will be based upon the ratio set by Clock Ratio (CR)</p> <p>34</p> <hr/> <p>Up/Down, sets I/O 7 and 8 to receive Clock Up/Clock Down inputs from an external source. The motion will occur based upon the input clock frequency in the direction relative to the input being clocked. The step rate will be based upon the ratio set by Clock Ratio (CR)</p> <p>35</p>
Output Types	<p>Step clock pulses will be output from Point 7, Direction from Point 8. The step clock output rate will be based upon the Pulse Width set by Clock Width (CW). The logic state of the Direction output will be with respect to the direction of the motor.</p> <p>49</p> <hr/> <p>Will output Quadrature signals.</p> <p>50</p> <hr/> <p>Will output Clock Up/Clock Down signals. The step clock output rate will be based upon the Pulse Width set by Clock Width (CW). The Active output will be based on the motor direction.</p> <p>51</p>
Parameter 2	<p>0 Active when LOW (default)</p> <p>1 Active when HIGH</p>
Usage	Program/Immediate, Read/Write
Code Example	<pre>S7=33,0 'I07 = step/direction input, active LOW S8=33,0 'I08 = step/direction input, active LOW S7=50,1 `I07 = quadrature output, active HIGH S8=50,1 `I08 = quadrature output, active HIGH</pre>
Related	FM, CW, CM

S13 (Setup capture input/trip output)

Compatible with Motion Control products:
 MDrive
 MDrive (Plus² expanded features)
 MDrive (Ethernet)
 MDrive Hybrid
 MDrive Hybrid (Ethernet)
 MForce
 MForce (Plus² expanded features)

Mnemonic	S13
Function	Set up capture/trip I/O point
Type	Instruction
Description	Sets up high speed position capture input and position trip output.
Syntax	S13=<type>,<active>
Input Type	60 The Capture input is a momentary high speed input that operates with the Trip Capture (TC) variable to run a subroutine upon the trip. It feature variable input filtering ranging from 50 nS to 12.9 μS
Output Type	61 The trip output will activate on Position Trips (TP) or Trip Relative (TR). The output will pulse out at the trip point. The pulse width will be determined by Clock Width (CW)
Parameter 2	0 Active when LOW (default) 1 Active when HIGH
Usage	Program/Immediate, Read/Write
Code Example	S13=60,0 'Set up IO13 as High Speed Capture 'Input, active LOW (default)
Notes	Note that this I/O Point is for position capture and trip ONLY. It is not effected by any other trips.
Related	FC, CW, TP, TR, PC

SC (Start calibration)

Compatible with Motion Control products:
 MDrive Hybrid

Mnemonic	SC
Function	Start calibration
Type	Instruction
Description	Starts calibration
Syntax	SC <mode>
Units	—
Range	0 — 1
Modes	0 Start calibration 1 Start configuration test (unneeded for MDrive)
Default	0
Usage	Program/Immediate, Write
Code Example	SC 'start calibration
Notes	The motor will rotate one half of a revolution during configuration test. Ensure the motor is safe to move before starting calibration.
Related	CA

SF (Stall factor)

Compatible with Motion Control products:
 MDrive
 MDrive (Plus² expanded features)
 MDrive (Ethernet)
 MForce
 MForce (Plus² expanded features)

Mnemonic	SF
Function	Stall factor
Type	Variable
Description	If the encoder is enabled (EE = 1) and the encoder differs from the commanded position by more than the specified factor, a STALL is indicated. If SM is set to 0, then the motor will be stopped when a STALL is detected. If SM=1, the motor will not be stopped upon detection of a stall. ST will return an ER=86 on stall.
Syntax	SF=<counts>
Units	Encoder counts
Range	0 to 65000
Default	15
Usage	Program/Immediate, Read/Write
Code Example	SF=20 'Set the stall factor for 20 counts
Related	EE, SM, ST, PM

SL (Slew axis)

Compatible with Motion Control products:
 MDrive
 MDrive (Plus² expanded features)
 MDrive (Ethernet)
 MDrive Hybrid
 MDrive Hybrid (Ethernet)
 MForce
 MForce (Plus² expanded features)

Mnemonic	SL
Function	Slew Axis
Type	Instruction
Description	The SL instruction will slew the axis at the specified velocity in steps per second. The axis will accelerate at the rate specified by the A (Acceleration) variable. Note that the maximum slew velocity is independent of the maximum velocity specified by the VM variable. If a slew is commanded at a velocity greater than the setting of VM, the axis will accelerate to the SL velocity regardless of the setting of VM.
Syntax	SL <velocity>
Units	Motor Steps (EE=0)/Encoder Counts (EE=1)
Range	±5000000 (EE=0)/±200000 (EE=1)
Usage	Program/Immediate, Read/Write
Code Example	SL 20000 'Slew at a rate of 20000 steps/sec
Notes	If 'SL 0' is issued after a MA/MR, motion has to come to a stop before issuing another motion command. This can be accomplished automatically with an 'H', <HOLD>, in user program mode.
Related	MA, MR, VI

SM (Stall detect mode)

Compatible with Motion Control products:
 MDrive
 MDrive (Plus² expanded features)
 MForce
 MForce (Plus² expanded features)

Mnemonic	SM				
Function	Stall detection mode				
Type	Variable				
Description	<p>The SM variable specifies the action which will be taken by the device when a stall is detected. When set to 0 (default) the motion will be stopped upon a stall detection. When SM=1, the motor will try to continue the move. In either case ST (Stall Flag) will be set.</p> <p>The functionality of SM when used with Position Maintenance (PM) is listed below:</p> <p>If SM = 0 and PM = 1, Position Maintenance will take place provided the position does not exceed the Stall Factor (SF).</p> <p>If SM = 1 and PM = 1, Position Maintenance will take place even if the Stall Factor (SF) is exceeded, unless VI is set too high causing the motor to stall.</p>				
Syntax	SM <mode>				
Modes	<table border="0"> <tr> <td>0</td> <td>Motion stops on stall detect (default)</td> </tr> <tr> <td>1</td> <td>Motion will attempt to continue</td> </tr> </table>	0	Motion stops on stall detect (default)	1	Motion will attempt to continue
0	Motion stops on stall detect (default)				
1	Motion will attempt to continue				
Default	0				
Usage	Program/Immediate, Read/Write				
Code Example	<pre>SM=1 'Change Stall mode that the motor doesn't 'stop on stall detect</pre>				
Related	EE, SM, ST, PM, SF				

SN (Serial number)

Compatible with Motion Control products:
 MDrive
 MDrive (Plus² expanded features)
 MDrive Hybrid
 MForce
 MForce (Plus² expanded features)

Mnemonic	SN
Function	Serial number
Type	Variable
Description	Keyword allows the user to read the device serial number.
Syntax	PR SN
Usage	Read
Code Example	<pre>PR SN 'read the device serial number</pre>

SS (System speed)

Compatible with Motion Control products:
MDrive Hybrid
MDrive Hybrid (Ethernet)

Mnemonic	SS
Function	Set system speed
Type	Instruction
Description	Sets maximum response frequency for fixed or variable current modes (AS=1 or 2)
Syntax	SS=<integer>
Units	steps/sec
Range	38,910 — 5,000,000
Default	0
Usage	Program/Immediate, Read/Write
Code Example	SS=50000 'set max. osc freq to 50000 'steps/sec
Related	AS, TS, MU

ST (Stall flag)

Compatible with Motion Control products:
MDrive
MDrive (Plus² expanded features)
MForce
MForce (Plus² expanded features)

Mnemonic	ST
Function	Stall flag
Type	Flag
Description	The ST flag will be set to 1 when a stall is detected. It is the responsibility of the user to reset it to zero (0). Encoder function must be enabled (EE=1) in order for a stall flag to set.
Syntax	PR ST BR <addr>, ST=1 CL <addr>, ST=1
Status	0 Not stalled (default) 1 Stalled
Default	0
Usage	Program/Immediate, Read/Write
Code Example	CL K5,ST=1 'Call subroutine K5 if motor stalls ST=0 'Clear stall flag
Related	EE, SF, OE

SU (Execute program on power up)

Compatible with Motion Control products:
 MDrive
 MDrive (Plus² expanded features)
 MDrive (Ethernet)
 MDrive Hybrid
 MDrive Hybrid (Ethernet)
 MForce
 MForce (Plus² expanded features)

Mnemonic	SU
Function	Execute program labeled SU on power up
Type	Predefined label
Description	The Start up label will cause any program labeled SU to automatically execute on power-up.
Syntax	LB SU
Usage	Program
Code Example	LB SU `Label program to executes on power up.

TA (Trip on Hybrid status)

Compatible with Motion Control products:
 MDrive Hybrid
 MDrive Hybrid (Ethernet)

Mnemonic	TA										
Function	Trip on hybrid status										
Type	Variable										
Description	Will execute a subroutine address or label on the trip. The trip can be set to occur on any or all of three conditions: calibration done, hybrid active, locked rotor or lead/lag limit reached conditions.										
Syntax	TA <flag>,<address/label>										
Units	—										
Range	0 — 7										
Trip Condition	<table border="0"> <tr> <td>1</td> <td>Calibration done</td> </tr> <tr> <td>2</td> <td>Hybrid active</td> </tr> <tr> <td>4</td> <td>Locked rotor</td> </tr> <tr> <td>8</td> <td>Lag limit reached</td> </tr> <tr> <td>16</td> <td>Lead limit reached</td> </tr> </table>	1	Calibration done	2	Hybrid active	4	Locked rotor	8	Lag limit reached	16	Lead limit reached
1	Calibration done										
2	Hybrid active										
4	Locked rotor										
8	Lag limit reached										
16	Lead limit reached										
Default	0 (Off)										
Usage	Program/Immediate, Read/Write										
Code Example	TA=4,k6 `execute subroutine k6 on locked rotor condition										
Notes	<p>The conditions are additive, eg. TA=3 will trip on calibration complete and hybrid active status.</p> <p>There is no error generation when enabling trip on locked rotor, lag limit or lead limit.</p>										

TC (Trip capture)

Compatible with Motion Control products:
 MDrive (Plus² expanded features)
 MDrive (Ethernet)
 MDrive Hybrid
 MDrive Hybrid (Ethernet)
 MForce (Plus² expanded features)

Mnemonic	TC
Function	Trip capture
Type	Variable
Description	Sets the Capture input trip for I/O 13. Sets one parameter for trip address. The TE command (Trip Enable/Disable TC) is reset when trip occurs. TE must be re-enabled in the main program prior to the next trip if it is to be repeated. The Trip subroutine must use a RETURN (RET) to exit the subroutine, use of a BRANCH will cause stack errors.
Syntax	TC=<address/label>
Usage	Program/Immediate, Read/Write
Code Example	TC=K1 `Run subroutine K1 on Input Trip TE=4 `Re-enable Trip
Related	TE, S13

TD (Torque direction)

Compatible with Motion Control products:
 MDrive Hybrid
 MDrive Hybrid (Ethernet)

Mnemonic	TD
Function	Set torque direction
Type	Variable
Description	Sets torque direction to + or -
Syntax	TD=<dir>
Units	—
Range	0 — 1
Modes	0 Minus (CCW facing shaft) 1 Plus (CW facing shaft)
Default	1
Usage	Program/Immediate, Read/Write
Code Example	TD=0 `set torque direction to minus
Notes	Takes effect when torque mode starts
Related	AS, TQ, TS

TE (Trip enable)

Compatible with Motion Control products:
 MDrive
 MDrive (Plus² expanded features)
 MDrive (Ethernet)
 MDrive Hybrid
 MDrive Hybrid (Ethernet)
 MForce
 MForce (Plus² expanded features)

Mnemonic	TE														
Function	Trip enable														
Type	Flag														
Description	The trip functions may be combined by adding trip numbers. For example TE=3 will trip on input or on position, TE=63 enables all trips. When multiple trips are used only the activated trip function needs to be re-enabled, the other trips will still be enabled.														
Syntax	TE=<trip>														
Range	0 — 63														
Trip	<table border="0"> <tr> <td>0</td> <td>Disabled (default)</td> </tr> <tr> <td>1</td> <td>Trip on input enabled</td> </tr> <tr> <td>2</td> <td>Trip on position enabled</td> </tr> <tr> <td>4</td> <td>Trip on capture (I/O 13) enabled</td> </tr> <tr> <td>8</td> <td>Trip on time enabled</td> </tr> <tr> <td>16</td> <td>Trip on relative position</td> </tr> <tr> <td>32</td> <td>Trip on Hybrid status</td> </tr> </table>	0	Disabled (default)	1	Trip on input enabled	2	Trip on position enabled	4	Trip on capture (I/O 13) enabled	8	Trip on time enabled	16	Trip on relative position	32	Trip on Hybrid status
0	Disabled (default)														
1	Trip on input enabled														
2	Trip on position enabled														
4	Trip on capture (I/O 13) enabled														
8	Trip on time enabled														
16	Trip on relative position														
32	Trip on Hybrid status														
Default	0 (Off)														
Usage	Program/Immediate, Read/Write														
Code Example	<pre>TE=1 `Enable trip on input function TE=8 `Enable trip on time function TE=6 `Trip on Position or Capture input.</pre>														
Related	I1-I4, I9-I12, P, S1-S4, S9-S12, TI, TP, TC, TT														

TI (Trip on input)

Compatible with Motion Control products:
 MDrive
 MDrive (Plus² expanded features)
 MDrive Hybrid
 MForce
 MForce (Plus² expanded features)

Mnemonic	TI
Function	Trip on input
Type	Variable
Description	<p>Sets up an input event (Trip) for the specified input. There are two parameters for the TI variable. The first specifies which input line to monitor. The second specifies the subroutine that should be executed when the input goes to true. The Trip subroutine must use a RETURN (RET) to exit the subroutine, use of a BRANCH will cause stack errors</p> <p>The TE is reset when a Trip occurs. TE must be re-enabled prior to the next Trip if it is to be repeated.</p>
Syntax	TI=<input>,<address/label>
Usage	Program/Immediate, Read/Write
Code Example	<pre>TI=2,K3 `execute subroutine K3 when input 2 active TE=1 `Re-enable Trip</pre>
Related	I1-4, S1-4, TE, TP, TT

TP (Trip on position)

Compatible with Motion Control products:
 MDrive
 MDrive (Plus² expanded features)
 MDrive (Ethernet)
 MDrive Hybrid
 MDrive Hybrid (Ethernet)
 MForce
 MForce (Plus² expanded features)

Mnemonic	TP
Function	Trip on position
Type	Variable
Description	<p>Sets up an event (trip) for the specified position. There are two parameters for the TP variable. The first specifies the position which will cause the event. The second specifies the subroutine that should be executed when the position is detected.</p> <p>The TE (Trip Enable which Enables/Disables TP) is reset when a Trip occurs. TE must be re-enabled in the main program prior to the next Trip if it is to be repeated. The Trip subroutine must use a RETURN (RET) to exit the subroutine, use of a BRANCH will cause stack errors.</p> <p>Trips should be set BEFORE motion commands in the program.</p>
Syntax	TP=<position>,<address/label>
Usage	Program/Immediate, Read/Write
Code Example	<pre>TP=650000,K9 `exe sub K9 when position = 650000 TE=2 `Re-enable trip</pre>
Notes	Note that TP will always use motor counts regardless of the encoder enabled state (EE=1)
Related	P, TI, PC, S13, CW

TQ (Set torque)

Compatible with Motion Control products:
 MDrive Hybrid
 MDrive Hybrid (Ethernet)

Mnemonic	TQ
Function	Set torque
Type	Variable
Description	Sets the maximum out put torque of the motor to a percentage.
Syntax	TQ=<percent>
Units	Percent
Range	1 — 100
Default	25%
Usage	Program/Immediate, Read/Write
Code Example	TQ=50 `set torque to 50%
Related	AS, CT

TR (Trip on relative position)

Compatible with Motion Control products:
 MDrive (Plus² expanded features)
 MDrive (Ethernet)
 MDrive Hybrid
 MDrive Hybrid (Ethernet)
 MForce (Plus² expanded features)

Mnemonic	TR
Function	Trip on relative position
Type	Variable
Description	<p>Sets up an event (trip) for the specified relative position. There are three parameters for the TR variable.</p> <p>The first specifies the position which will cause the event.</p> <p>The second specifies the subroutine that should be executed when the position is detected, if no subroutine address or label is specified then the High Speed Trip Output will activate. The Trip subroutine must use a RETURN (RET) to exit the subroutine, use of a BRANCH will cause stack errors</p> <p>The third parameter specifies the number of times the trip will repeat. If 0 (default) the trip will repeat infinite times, other wise the range is 1- 65000</p> <p>The TE (Trip Enable which Enables/Disables TR) is reset after repeating the number of relative trips specified. TE must be re-enabled in the main program prior to the next series of Trip on Relative if it is to be repeated. For exampl, if TR=10000,0,25, the Output (S13) will trip 25 times in succession at 100,000 counts relative to the last position. Following these 25 trips the trip must be re-enabled (TE=16).</p> <p>Trips should be set BEFORE motion commands in the program.</p>
Syntax	TR=<±dist>,<address/label>, <repeat>
Usage	Program/Immediate, Read/Write
Code Example	<pre>TR=650000,0,0 'Activate trip out when at 650000 'counts relative TE=16 'Re-enable trip TR=512000,K2,27 'Run Sub K2 when at 512000 rel, 'repeat 27 times TE=16 'Re-enable trip</pre>
Notes	<p>Note: Output S13 must be configured as a trip output (S13=61,1/0)</p> <p>Note that TR will always use motor counts unless the encoder is enabled (EE=1).</p> <p>Note: The maximum rate of trip is 20 kHz. Exceeding this may cause communications errors</p>
Related	P, TI, PC, S13, CW

TS (Set torque speed)

Compatible with Motion Control products:
MDrive Hybrid
MDrive Hybrid (Ethernet)

Mnemonic	TS
Function	Set torque speed
Type	Instruction
Description	Determines the system speed for torque mode (AS=3) Hybrid will perform the following calculation based upon the value of TS:
Syntax	TS=<integer>
Units	steps/second
Range	38,910 — 5,000,000
Default	0
Usage	Program/Immediate, Read/Write
Code Example	TS=50000 `set spd to 50000 steps/sec
Related	AS, SS, MSEL

TT (Trip on position)

Compatible with Motion Control products:
MDrive
MDrive (Plus² expanded features)
MDrive (Ethernet)
MDrive Hybrid
MDrive Hybrid (Ethernet)
MForce
MForce (Plus² expanded features)

Mnemonic	TT
Function	Trip on time
Type	Variable
Description	Sets up a trip based on time. The first parameter is time in mSec. The second parameter specifies the subroutine that should be executed when the time is expired. The Trip subroutine must use a RETURN (RET) to exit the subroutine, use of a BRANCH will cause stack errors
Syntax	TT=<time>,<address/label>
Units	Milliseconds
Range	1 to 65535
Usage	Program/Immediate, Read/Write
Code Example	TT=2000,K3 `Trip on time 2000 mS, run- sub K3 TE=8 `Re-enable trip
Related	TE, TP, T

UG (Upgrade firmware)

Compatible with Motion Control products:
 MDrive
 MDrive (Plus² expanded features)
 MDrive (Ethernet)
 MDrive Hybrid
 MDrive Hybrid (Ethernet)
 MForce
 MForce (Plus² expanded features)

Mnemonic	UG
Function	Upgrade firmware
Type	Instruction
Description	Upgrade Firmware Instruction. Upgrade code is 2956102. This will put the device in Upgrade Mode. Once set, the firmware Upgrade MUST be completed.
Usage	Immediate

UV (Read user variables)

Compatible with Motion Control products:
 MDrive
 MDrive (Plus² expanded features)
 MDrive (Ethernet)
 MDrive Hybrid
 MDrive Hybrid (Ethernet)
 MForce
 MForce (Plus² expanded features)

Mnemonic	UV
Function	Read user variables
Type	Variable
Description	Read User Variables is used with the PR (Print) Instruction to read the value of all user variables.
Syntax	PR UV
Usage	Program/Immediate, Read
Code Example	PR UV `Read the value of all user variables
Related	PR, VA

V (Read velocity)

Compatible with Motion Control products:
 MDrive
 MDrive (Plus² expanded features)
 MDrive (Ethernet)
 MDrive Hybrid
 MDrive Hybrid (Ethernet)
 MForce
 MForce (Plus² expanded features)

Mnemonic	V
Function	Read axis velocity
Type	Variable
Description	The velocity variable is used in conjunction with the PR (print) instruction to read the current velocity of the axis in counts per second. This variable can also be used with the BR and CL instructions to set a condition based upon a velocity.
Syntax	PR V BR <address/label>, V=<velocity> BR <address/label>, V=<velocity>
Usage	Program/Immediate, Read
Code Example	PR V `Read the velocity CL Ka, V=20000 `Execute sub Ka when velocity is `20000/steps sec in the + direction CL Kb, V=-20000 `Execute sub Kb when velocity is `-20000/steps sec in the - irection
Notes	Note that V is signed. When using an Hybrid product V will not return an accurate value when Hybrid make up is active. In torque mode V will return 0.
Related	VI, VM, SL, MA, MR

VA (Create user variable)

Compatible with Motion Control products:
 MDrive
 MDrive (Plus² expanded features)
 MDrive (Ethernet)
 MDrive Hybrid
 MDrive Hybrid (Ethernet)
 MForce
 MForce (Plus² expanded features)

Mnemonic	VA
Function	Create user variable name
Type	Instruction
Description	<p>The VA instruction creates a user variable with a 1 or 2 character name. Can optionally set value assigned to that variable.</p> <p>The restrictions for this command are:</p> <ol style="list-style-type: none"> 1. A variable cannot be named after a MCode Instruction, Variable or Flag or Keyword 2. The first character must be alpha, the second character may be alpha-numeric. 3. A variable is limited to two characters. 4. Limited to 192 variables and labels.
Syntax	VA <char><char>=<value>
Usage	Program/Immediate, Read/Write
Code Example	<pre>VA Q3 `Create user Variable Q3 VA Q3=20000 `Create user Variable Q3, set to 20000</pre>
Related	UV

VC (Velocity changing)

Compatible with Motion Control products:
 MDrive
 MDrive (Plus² expanded features)
 MDrive (Ethernet)
 MDrive Hybrid
 MDrive Hybrid (Ethernet)
 MForce
 MForce (Plus² expanded features)

Mnemonic	VC
Function	Velocity changing
Type	Flag
Description	<p>The read-only motion flag will be at an active state (1) when the velocity of the motor is changing, either accelerating or decelerating.</p>
Syntax	<pre>PR VC BR <addr>, VC=1 CL <addr>, VC=1</pre>
Range	0/1
Trip	<p>0 Motor stopped or at constant velocity (default)</p> <p>1 Velocity is changing</p>
Default	0 (not active)
Usage	Program/Immediate, Read/Write
Code Example	<pre>CL K5,VC=1 `Call sub K5 if velocity is changing PR VC `Print the state of the VC Flag</pre>
Related	MV, VI, VM, S1-S4, S9-S12

VF (Torque velocity filter)

Compatible with Motion Control products:
 MDrive
 MDrive (Plus² expanded features)
 MDrive (Ethernet)
 MDrive Hybrid
 MDrive Hybrid (Ethernet)
 MForce
 MForce (Plus² expanded features)

Mnemonic	VF
Function	Set torque velocity filter
Type	Variable
Description	VF takes a value of 0 to 1000. It can be defined as 0 = no filtering and 1000 = most filtering. Because the Torque Velocity is computed and the encoder is sampled every mSec there can be fluctuation in the result. The filtering compensates for this fluctuation.
Syntax	VF=<integer>
Units	Counts
Range	0 to 1000
Default	0
Usage	Program/Immediate, Read/Write
Code Example	VF=100 `Set filtering to 100 counts

VI (Initial velocity)

Compatible with Motion Control products:
 MDrive
 MDrive (Plus² expanded features)
 MDrive (Ethernet)
 MDrive Hybrid
 MDrive Hybrid (Ethernet)
 MForce
 MForce (Plus² expanded features)

Mnemonic	VI
Function	Initial velocity
Type	Variable
Description	Initial velocity for all motion commands. The factory default value is 1000 clock pulses (steps) per second. The initial velocity for a stepper should be set to avoid the low speed resonance frequency and must be set lower than the pull in torque of the motor. It must also be set to a value lower than VM (Max. Velocity).
Syntax	VI=<velocity>
Units	Motor Steps (EE=0)/Encoder Counts (EE=1)
Range	1 to (VM -1)
Default	1000/40
Usage	Program/Immediate, Read/Write
Code Example	VI=10000 `Set initial vel to 10000 steps/sec.
Related	VM, MR, MA, HI, HM, JE

VM (Maximum velocity)

Compatible with Motion Control products:
 MDrive
 MDrive (Plus² expanded features)
 MDrive (Ethernet)
 MDrive Hybrid
 MDrive Hybrid (Ethernet)
 MForce
 MForce (Plus² expanded features)

Mnemonic	VM
Function	Maximum velocity
Type	Variable
Description	The VM variable specifies the maximum velocity in steps/counts per second that the axis will reach during a move command. VM must be greater than VI.
Syntax	VM=<velocity>
Units	Motor Steps (EE=0)/Encoder Counts (EE=1)
Range	(VI + 1) to 5000000 (EE=0)/200000 (EE=1)
Default	768000/30720
Usage	Program/Immediate, Read/Write
Code Example	VM=500000 `Set max vel to 500000 steps/counts sec.
Related	VI, MR, MA, HI, HM, JE

VR (Firmware version)

Compatible with Motion Control products:
 MDrive
 MDrive (Plus² expanded features)
 MDrive (Ethernet)
 MDrive Hybrid
 MDrive Hybrid (Ethernet)
 MForce
 MForce (Plus² expanded features)

Mnemonic	VR
Function	Firmware version
Type	Variable
Description	This variable is used in conjunction with the PR instruction to read the version of the firmware installed at the factory.
Syntax	PR VR
Usage	Read
Code Example	PR VR `Read the firmware version installed
Notes	Hybrid products will return a second value for the hardware version.
Related	UG

WT (Warning temperature)

Compatible with Motion Control products:

MDrive
 MDrive (Plus² expanded features)
 MDrive (Ethernet)
 MDrive Hybrid
 MDrive Hybrid (Ethernet)
 MForce
 MForce (Plus² expanded features)

Mnemonic	WT
Function	Warning temperature
Type	Variable
Description	The Warning Temperature variable allows the user to set a threshold temperature at which the device will print an error 71 to the terminal screen if the set temperature is exceeded.
Syntax	WT=<temp>
Units	Degrees C
Range	0 to 84
Default	80
Usage	Program/Immediate, Read/Write
Code Example	WT=75 `set the warning temperature to 75 deg. C
Notes	NOTE: This functionality is only standard on MDrive 34 (DC and AC), MForce PowerDrive and all Hybrid devices.
Related	IT

6 Supporting Software

There are two programs provided for configuring, controlling and programming the Motion Control products. These are:

1. **IMS Terminal:** integrated ASCII program editor/ANSI terminal emulator used to program and immediate mode control the Motion Control products.
2. **TCP/IP Configuration Utility:** configuration tool used to setup and test the Ethernet MDrive Motion Control products. When using the product in MCode/TCP mode, this tool is primarily used to set the device IP address and test connectivity and functionality before using IMS Terminal for configuration and programming.

6.1 IMS Terminal

IMS Terminal is an Integrated Program Editor and Terminal Emulator designed to communicate with and program IMS products including the MCode devices, the Motion Control MDrive, MForce and Hybrid products. For purpose of this document the focus will be on the devices utilizing the MCode language.

The upgrader utility included with IMS Terminal is required if you desire to upgrade the firmware in your MCode device.

6.1.2 Features

General features

- Multiple program editor windows allowed.
- Multiple Terminal Windows allowed which can be connected to multiple devices and device types.
- Configurable initialization file (lynxterm.lxt) allows Program Editor and Terminal Window states and configurations to be remembered and opened upon startup.

Program editor window

- Color-coded text to easily differentiate command types.
- Auto-indent for program blocks.
- Lines of code may be commented using the apostrophe (') character.
- Files may be text (*.txt) formatted or MCode (*.mxt) formatted. Note the color-coded text is only available in the MCode format.
- Color-coding, indenting, font type, size and style are user configurable through the preferences dialog.

Terminal emulator window

- Programmable function keys set in groups of ten.
- Multiple function key groupings.
- Special "Capture Mode" allows the capture of all terminal communications to a text file.
- Terminal Window Status, i.e. Connected/Disconnected, Port #, BAUD Rate and etc. displayed on a clickable bar across the bottom of the Terminal Window.

6.1.3 Installing IMS Terminal

System requirements

- IBM Compatible PC.
- Windows XP Service Pack 2 or greater.
- A free USB or serial communications port.

Installation

- 1) Download the software from the IMS web site at http://motion.schneider-electric.com/downloads/software_interfaces.html.
- 2) Extract to a location on your hard drive.
- 3) In the folder location of the extracted files, double click "setup.exe"
- 4) Follow the on-screen prompts to complete the installation of IMS Terminal.

6.1.4 Screen and menu overview

IMS Terminal main screen

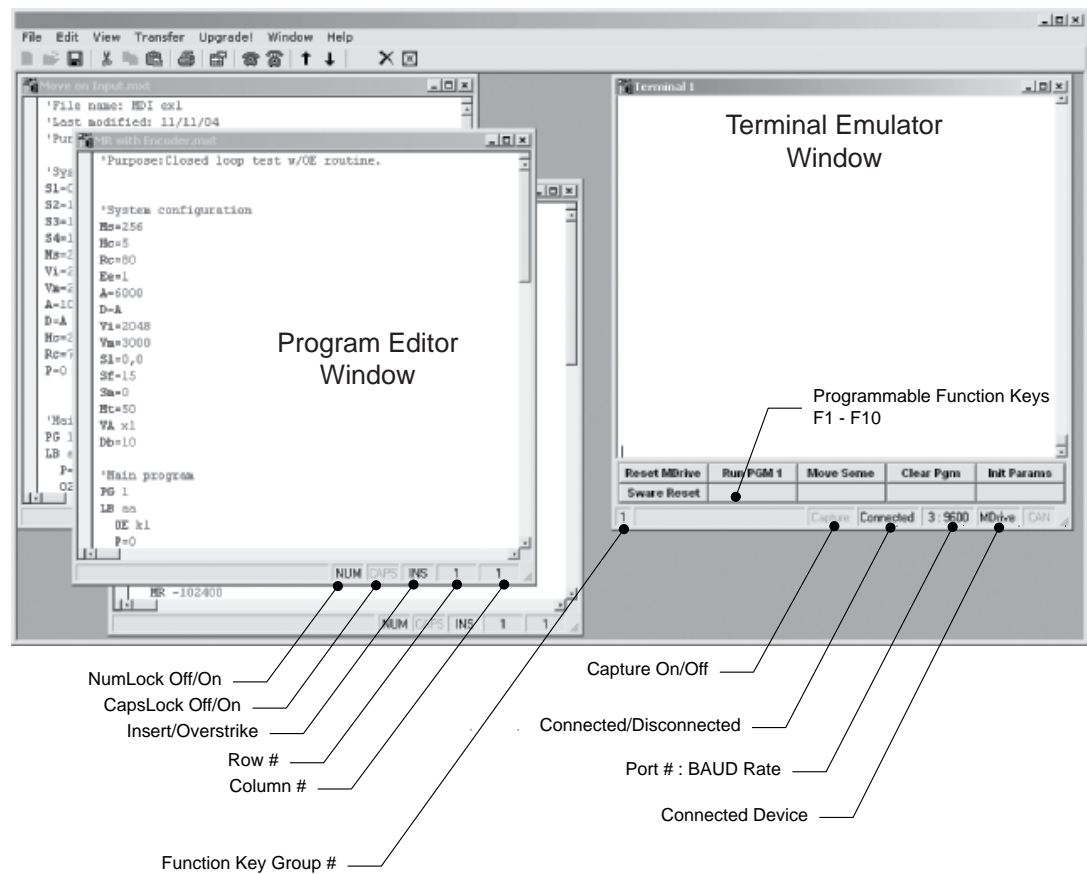

Figure 6.1 IMS Terminal main screen

6.4.2 The menu bar structure and operation

Most of the functions of the IMS Terminal are accessible through the menu bar. Please note that some of the menu bar functions will differ based upon the type of window which is active, either Program Editor or Terminal.

File menu functions

File menu functions, when used in the program editor, are common to most windows programs. When the terminal window is in an active state, the new, open and save items will disable. Save as will allow the user to save the contents of the terminal window, including the scroll back buffer, if desired to a text file.

6.4.3 Edit menu operation

As with the file menu, many of the edit menu functions are familiar to windows users such as redo, undo, copy, cut, paste, delete, select all, find, find next and replace. These will function as they do with other windows-based software programs. Of these, only copy and paste will be available if a terminal window is active.

Preferences

The preferences item will open a tabbed dialog with the various window configuration settings. If selected with the program editor window active, it will display the font, color, style selections for the program window.

If selected with the terminal window active, it will display the visual configurations settings for the terminal window. These configurations will be discussed in detail later in this section.

Open preferences

The preferences settings are all saved in a single *.ltn file, the default being lynxterm.ltn. These files contain the following preference settings:

- Text editor preferences
- Program editor preferences
- Terminal format preferences
- Terminal window communications settings
- Open program or text files
- Open terminal windows
- Function key and group configuration

IMS terminal will automatically save the settings on exit to the filename you have loaded.

Save preferences

- Save preferences will save the current preferences to the loaded file.
- Save preferences as
- Save preferences as different *.ltn filename.

View menu operation

The only applicable functions to MCode devices are the menu items:

- New edit window
- New terminal window

The operation of these options are covered later in this section

Transfer menu operation

The transfer menu controls the transfer of data to and from the MCode device.

Upload

Upload will open a dialog which will allow the user to selectively transfer the stored global variable and flag declarations and programs to a new or open program editor window.

Download

The download menu item will open a dialog allowing the user to selectively download variable and flag declarations and programs to the MCode compatible device from either an open program editor window or a saved *.mxt file.

Capture

The capture menu item will place the active terminal window into a special "capture mode". When in capture mode all terminal activity is captured to a text file in real time. The on/off state of capture mode is displayed on the bottom indicator bar of the active terminal window.

When in capture mode, two additional menu items appear on the transfer menu:

- Pause capture
- Stop capture

These will function as described by their label.

Upgrade menu operation

The upgrade! menu item will open the IMS Terminal upgrader utility for upgrading the firmware in your MCode device. It will not place your device in the upgrade mode for upgrading.

Window menu operation

The Window menu offers the options common to most Microsoft Windows™ programs.

6.1.5 Configuring IMS Terminal

Configuring program editor format preferences

The program editor features a number of enhancements designed to aid the user in programming IMS MCode products by the use of color-coded text and automatic tabbing to separate program blocks and subroutines for easier code editing and debugging.

While the default format of the program editing window is sufficient for most users, you may configure the format to your preference.

To open the program editor preferences dialog:

- 1) Right-click into the program editor window.
- 2) Select preferences.
- 3) The program editor format tab of the preferences dialog will open.
- 4) Set the format to that which you desire.

Note that the use of a mono-spaced font such as the default, courier new, makes code editing and debugging much easier than using a variable spaced font.

Configuring terminal window format preferences

The terminal window features similar formatting preferences as the program editor.

- 1) To open the terminal format preferences dialog:
- 2) Right-click into the terminal window.
- 3) Select preferences.
- 4) The terminal format tab of the preferences dialog will open.
- 5) Set the format to that which you desire.

Configuring communications settings

The communications settings are configured by means of the preferences dialog.

The optimum communications settings for the MCode compatible device are set by default. The only thing that will need to be set to begin communicating with your MCode device is to set the COM port to which your rs-422/485 communications converter is connected, or the IP address if using an Ethernet based product (default 192.168.33.1).

- 1) Open the communications preferences dialog by either opening the preferences from the menu bar and selecting the comm settings tab, or double clicking the port: baud rate field on the status bar at the bottom of the terminal window.
- 2) Select the device you are communicating with:
MDI - MDrive or MForce
ASI - Hybrid
The communication settings will automatically be set for the device selected.
- 3) The window size and function key settings are optional.
- 4) Once you have selected the correct com port, click ok.
- 5) Verify hardware connections and apply power to the MCode device.
- 6) If not already connected, connect to the device by clicking the "connect" icon on the button bar, or by double clicking the disconnected field on the status bar of the terminal window.
- 7) Key in ctrl+c.
- 8) The sign-on message below should appear.

The sign-on message should appear:

```
Copyright 2001 - 2010 by Schneider Electric Motion USA  
>
```

The sign-on message indicates that you are up and running. You may now begin to issue immediate mode commands and/or download programs to your device!

6.1.6 Troubleshooting communications

Troubleshooting the communications converter

- 1) Go to the start menu on Windows XP.
- 2) Right click “my computer”, select “properties”.
- 3) On the system properties dialog, click the tab labeled “hardware”.
- 4) Click the device manager button.
- 5) On the device manager window, click the “+” sign next to ports (com and lpt) to expand the category.
- 6) The RS-422 converter should be listed there with its port number.
- 7) Verify that the port is the one configured in the communications settings for IMS Terminal.
- 8) If the communications converter does not show in the device manager verify that the drivers for the converter are installed per the converter manufacturer documentation.
- 9) If the converter will not install, contact the device manufacturer support desk.
- 10) Communications converter installed and functioning
- 11) Verify that all mating connectors are firmly seated.

If not using an IMS MD-CC40x-001 and appropriate adapter, verify the wiring.

Check the following connections:

Converter	MCode Device
RX+	TX+
RX-	TX-
TX+	RX+
TX-	RX-
GROUND.....	CGND

6.1.7 Configuring function keys

The ability to program MCode functions and code strings and assign a function key to them is one of the most powerful features of IMS Terminal.

Function Keys can also be grouped in whatever fashion the user desires. IMS Terminal supports up to 999 function groups.

The illustration below shows the function key dialog with example functions programmed in.

To open the function key dialog:

Right-click any of the function keys on the bottom of the terminal window or key-in CTRL+[F1-F10].

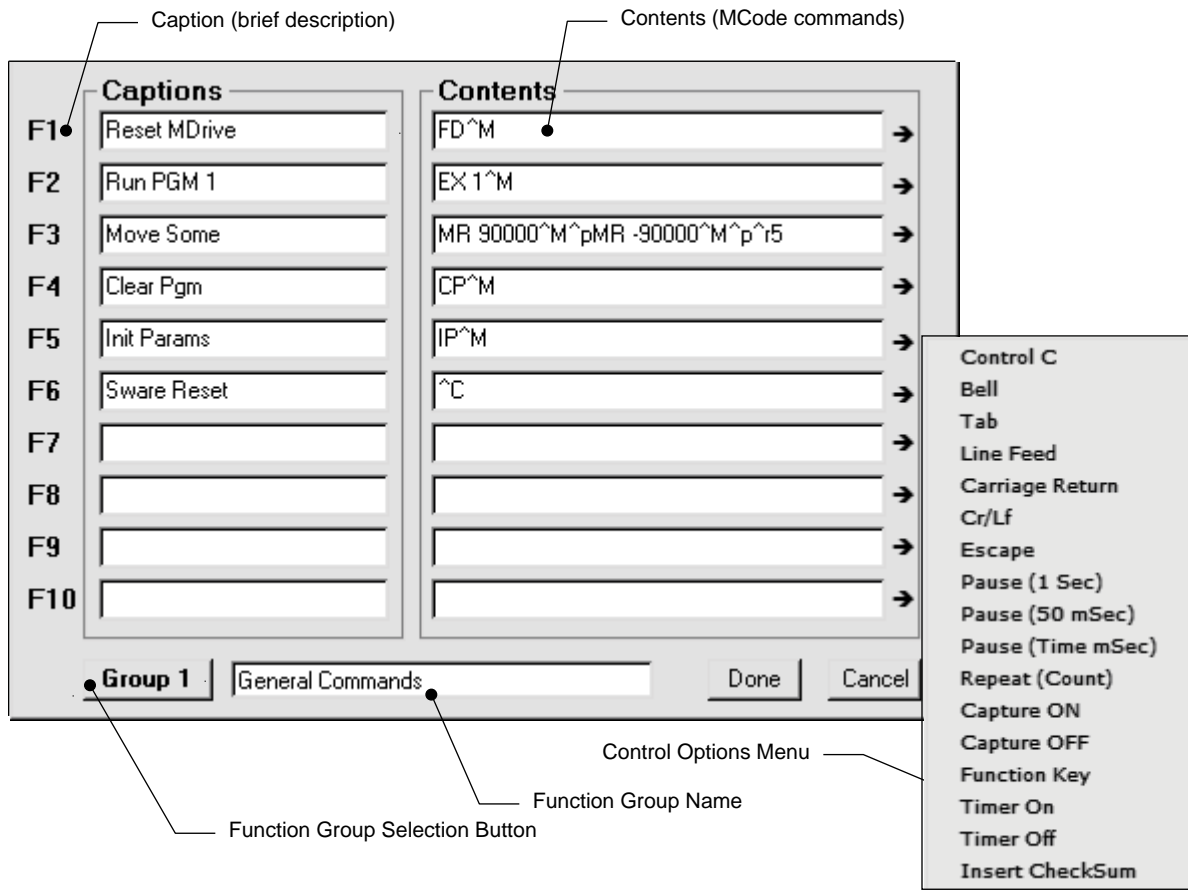

Figure 6.2 Function key setup dialog

Function key control commands

The IMS Terminal function keys have a number of control commands that are used to input or impact MCode strings sent to the terminal on function key press.

Function	Characters	Description
Control C	^C	MCode Software Reset
Bell	^G	Computer Beep
Tab	^t	Tabs cursor 5 spaces
Line Feed	^J	Sends a Line Feed
Carriage Return	^M	Sends a Carriage Return
Cr/Lf	^M^J	Sends a Carriage Return with a Line Feed
Escape	^[Sends an Escape
Pause (1 Sec)	^p	Pauses operation between command execution for 1 second
Pause (50 mSec)	^m	Pauses operation between command execution for 50 milliseconds
Pause (Time mSec)	^d<x>	Pauses operation between command execution for <x> milliseconds
Repeat (Count)	^r<x>	Repeats the string <x> times
Capture ON	^c	Turns on the IMS Terminal Capture Feature
Capture OFF	^o	Turns off the IMS Terminal Capture Feature
Function Key	^f<1-10>	Activates Function Key <1-10>. Can be used to send multiple command strings from the functions.
Timer On	^t1	Activates Timer. Time will display on the status bar. The Time will not update until the Timer is turned off
Timer Off	^t0	Deactivates Timer, updates time display on status bar.

Table 6.1 Function key control commands

6.1.8 Creating, downloading and uploading programs

Existing programs may be edited in the program editor window from a file on a disk, a file on the hard drive or a file uploaded from an MCode compatible device. You may also create a new program in the program editor window.



Note: your system must be connected and running to perform these steps as they are outlined.

Creating a new program

Before you create a program you must have a new program editor window open. Follow these steps:

- 1) Click on the drop-down menu “view”. The following dialog box will be displayed:
- 2) Click on “new edit window”.
- 3) You must assign a file name in order to open the new window. If there is no file name the “ok” button will not be highlighted. Name this file <my program.mxt>. The <mxt> extension designates MCode programs.
- 4) Click “OK” and the new program editor window will be displayed.

Naming the program with the <mxt> extension automatically formats the text color and makes most of the characters appear in upper case. When you type a program the text will be color coded. In complex programs it may be difficult to read the text easily. By formatting indents, the overall appearance and readability will be greatly improved.

Downloading a program to the device

NOTE: Before downloading any programs type FD into the terminal window and press ENTER to set the device to the factory defaults.

There are two basic sources from which you can download programs to the MCode compatible device:

- 1) Directly from the program editor window of the IMS Terminal.
- 2) From a file folder located on a hard drive or removable disk.

To download

- 1) Activate the Program Editor Window containing the Program
- 2) ~~MP.mxt~~ Click the menu item “Transfer > Download”. The download dialog box will open.
- 3) Click the download button on the main tool bar. The download dialog box will open. Select the “Source Type > Edit Window” option, and click download. The program will transfer to the device. If a program has been previously created and stored, it may be downloaded to the device from the *.mxt file.
- 4) Once the program is downloaded, type S and press ENTER to

Save the program. (Always save your programs!)

- 5) Now type EX 1 and press Enter or Click the Function button Run PGM 1. (EX=Execute and 100 is the Program Number.) The motor should move a short distance back and forth.

NOTE: The program can be stopped by pressing the escape button or by pressing <Ctrl+C>.

Uploading a Program



NOTE: Be certain the program is stopped by pressing the Escape Button or by pressing <Ctrl+C>.

There are two ways to upload programs from the MCode compatible device:

- 1) Directly to the program editor window of the IMS Terminal.
- 2) To a file folder located on a hard drive or removable disk.

There are also two ways to enable the upload dialog box.

- 1) Click the menu item “Transfer > Upload”. The upload dialog box will open.
- 2) Click the upload button on the main tool bar. The upload dialog box will open. The upload dialog box is similar in appearance to the download dialog box.

With the upload dialog box open, select the “Destination Type > Edit Window” option, click “Upload”. The program will transfer from the device.

Programs may also be uploaded from the device directly to a text file by selecting “Destination Type > File” as the destination and typing in a filename in the “File Name” box on the dialog box.

NOTE: When uploading MCode program files they will be slightly changed from the original. The device will upload the program only with the data within the program. That is, the data between the two program modes (PG). Data such as variables entered outside the PG modes will not be uploaded. The uploaded program will also have a header '[PROGRAMS] and a footer '[END]. These will not affect your program as they are remarked with the apostrophe (') or they can be removed during editing.

You may upload the program variables by clicking “Variables” in the upload dialog box. However, this will upload all of the current variables, not just those associated with the program.

6.1.9 Program troubleshooting using IMS Terminal

The IMS Terminal offers tools to help you troubleshoot and analyze programs. They are:

- Execute in single step mode
- Execute in trace mode
- The scroll back function
- The capture function

Single step mode

The single step mode allows the user to execute a program in the immediate mode one line at a time. This will help the user to define problem areas by process of elimination. To use single step mode, do the following:

It is recommended that you list (L) the program in the terminal window and either print it on paper or cut and paste it to another program edit window. This will allow you to look ahead and see what line is coming up next.

- 1) Have the system and the program ready to run.
- 2) To run in single step mode add a comma and the number two (2) to the execute command.

Example: the program label is <aa>. Type EX aa,2. The program will run one line at a time.

- 3) Each line will be executed and listed in the terminal window and the program will stop.
- 4) To execute and list the next line, press the space bar.
- 5) Press the space bar for each successive line until the program has completed.

While the program is executing, it will stop after each line is listed. At this time you may enter immediate commands such as velocity variables or actual moves as tests within the program. After entering immediate commands you may continue running in single step mode by pressing the space bar again.

If you decide to cancel the single step mode press the “enter” key and the program will run in normal mod and finish or press escape (esc) to abort the program.

Trace mode

The trace mode allows the user to run a program and list each line as it is executed. Running trace mode in conjunction with the scroll back function or the capture function will enhance your program troubleshooting tasks. To run trace mode:

- 1) Have the system and the program ready to run.
- 2) To run in Trace Mode add a comma and the number one (1) to the execute command.

Example: the program label is <aa>. Type ex aa,1. The program will run in trace mode and each line will be executed and listed in the terminal window.

- 3) Each line can now be analyzed.

On very large programs all of the lines may not be displayed if the “Scroll Back Buffer” value is set too low. The Scroll Back Buffer can be set to a higher value allowing you to Scroll Back farther in the program.

The capture function

The capture function allows you to capture terminal communications into a text file for the purpose of troubleshooting. You may have a program that fails after running a number of times. It may be from an accumulation of position errors or other factors. By enabling the capture function you can store an entire text file of the received communications to your hard drive for analysis.

Enable the capture function

The Capture function may be enabled through the drop-down menu under “Transfer”.

When you click on “Capture” a dialog box will be displayed.

Give the file you will be capturing a name and be certain to save it as a [.txt] file and click “Save”. Upon clicking Save, the faded (disabled) Capture title below the Function Keys will change to “Capture ON” and to black letters.

You are now ready to run the program. The program in this example will cycle five (5) times. The data will scroll up the Terminal Window while a copy of the data is captured into the text file simultaneously.

6.1.10 Upgrading firmware

Before upgrading the MCode firmware

IMPORTANT! It is recommended that you review this procedure in its entirety before performing the upgrade.

It is recommended that the most recent version of IMS Terminal Software be installed on your PC prior upgrading the firmware.

To check if you have the most recent version of IMS Terminal Software, click the “HELP” menu item on the IMS Terminal menu bar and then click “About IMS Terminal”. The following information block will appear.

The current version of your IMS Terminal Software will be shown as indicated by the arrow. Compare this version number with the IMS Terminal version number found on the IMS web site at motion.schneider-electric.com/software_interfaces.html. If a more recent version is shown on the web site, you should download and install it on your system before upgrading the firmware.

NOTE: The file you will be downloading is a self-extracting executable file. Download it to your desktop or a known folder.

To install the most recent version of IMS Terminal Software on your system perform the following steps:

NOTE: Skip Steps 1 & 2 if this is a new installation.

- 1) Open Windows Explorer and proceed to the folder “Program Files”.
- 2) Locate the folder named “IMS Terminal” and rename it to “IMS TermOLD”. This will preserve any files you want to save which can be retrieved later and it will also ensure a complete new installation of IMS Terminal.
- 3) Locate the downloaded version of IMS Terminal Software and Double Click the file.
- 4) A message regarding sharing files will appear. All other applications should be closed. Click OK.
- 5) In the window that follows, click the button to the left of the message to continue.
- 6) A dialog box will query you as to which program group you want IMS Terminal to be associated. Click CONTINUE to accept the default.
- 7) The installation will begin followed by the “Installed Successfully” message box. Click OK and the system is ready.

Upgrading the firmware

NOTE: Your MCode compatible device is configured with the most recent firmware at the time of shipment. The main reason for upgrading is to take advantage of new features that your system may need or to correct minor errors that may be causing problems in your system. Albeit, new features and corrections may be appealing, they may have little or no affect on your system operation. If your system is operating as it should, be hesitant about upgrading the firmware for the sake of “upgrading”. Before performing the upgrade procedure, verify the firmware version.

With the system running, type `<pr vr>` in the Terminal Window and press ENTER. The device will return the firmware version number. Compare this number with the latest version on the IMS web site at motion.schneider-electric.com/flash_code.html.

While at the web site, review the Change Summary for that version of the firmware. If none of the changes will help to correct a problem you may be having or improve your system operation, it is not necessary to upgrade.

Many problems are the result of programming errors. Verify that you do not have a programming problem that may mislead you to believe there is a problem with the firmware or your system.

If it is determined that a firmware upgrade is necessary, download the most recent version into a known folder from <http://motion.schneider-electric.com/downloads/firmware.html>.

During upgrades, the communication baud rate is switched from 9600 to 19,200 and is more susceptible to electrical noise. Your communications cable should be kept to a minimum length of 6 feet.

When using a laptop PC it is recommended that you power the RS-232 to RS-485 cable with an external +5 VDC power supply. This will fortify communications.

The device remains in the upgrade mode until the upgrade is complete. Cycling power will not clear the upgrade mode.

It is recommended that you use this procedure as it is tailored for the device while the on-screen instructions are designed for several different products.

- 1) Open "IMS Terminal". The following screen should be displayed. The left panel is the program edit window and the right panel is the terminal window. The firmware upgrade will superimpose several dialog boxes and instructions over these two windows.
- 2) Check to see that the terminal window is set for communication.
 - Right click in the terminal window.
 - Click "Preferences" near the bottom of the pop-up menu.
 - A "Preferences" dialog box will be displayed.
 - Click on the "Comm Settings" tab at the top of the box.
 - Confirm that device is selected in the "Devices" block.
MDI - MDrive or MForce
ASI - Hybrid
- 3) Power up the device.
 - The sign on message will appear.
"Copyright 2001-20010 by Schneider Electric Motion USA."
- 4) Check and/or reestablish communications if the sign on message does not appear.
- 5) Type UG 2956102 in the terminal window and then press <enter>. Include the space between the G and the 2.
 - The device will return a random symbol character (ô or ö) when it is in the upgrade mode.
- 6) Click the "Upgrade" menu item on the IMS Terminal menu bar.
- 7) Message appears: "During upgrade, the baud rate is changed to 19,200."
 - Click "OK"
- 8) The Windows Explorer page "Select device upgrade file" opens.
 - Browse and select the desired version of the upgrade file.
 - Click "Open" or double click the file.
- 9) Message appears: Step 2 Select upgrade file.
 - The upgrade version will now appear in the upgrade version window.
 - Click "Next"
- 10) Message appears: Step 3 Reminder Press cancel if you need to setup COMM port.
 - The COMM port has been setup previously. This is just a reminder.
 - Click "Next"
- 11) Message appears: Step 4 Connect RS-422 cable to the device.
 - The RS-422 has been connected previously. DO NOT perform this step.

-
- Click “Next”
- 12) Message appears: Step 5 If device is not in the upgrade mode, press cancel then type ‘UG 2956102’ in the terminal window.
 - The device was placed in the Upgrade mode previously. DO NOT ENTER CODE AGAIN.
 - Click “Next”
 - 13) Message: Step 6 Power up or cycle power to device.
 - The unit has been previously powered up. Do not cycle power.
 - Click “next”
 - 14) Message: Step 7 Establishing COMM with device.
 - Wait for step 8 to appear.
 - The previous version of firmware will now be displayed in the “Previous Version” window.
 - 15) Message: Step 8 Press upgrade button to start.
 - Click the upgrade button.
 - NOTE: An upper case E will be displayed in the “Type Number” window. This confirms the upgrade is functioning properly.
 - 16) Message: Step 9 Press ABORT to abort upgrade.
 - DO NOT abort the upgrade. The device remains in the upgrade mode and the upgrade must be completed.
 - Monitor the progress in the “Upgrading...%” window.
 - Step 10 will appear when DONE
 - 17) Message: Step 10 Resetting device. Then Press DONE.
 - Click “DONE”
 - Upgrade window will close.
 - 18) Press “Control + C” <Ctrl + C> while the Terminal Window is active to reset the device and exit the upgrade mode.
 - The sign on message will appear. “Copyright 2001-2008 by Intelligent Motion Systems, Inc.”
 - The > cursor will appear.
 - 19) The device firmware has been upgraded.
 - 20) Optional confirmation of the upgrade: Type “PR VR” in the terminal window and press <enter>.
 - The new firmware version is displayed.

6.2 TCP/IP Configuration Utility

The TCP/IP Configuration Utility is specifically for setting the Ethernet MDrive Motion Control IP address and basic functionality testing for use with MCode/TCP. We recommend using IMS Terminal for programming and controlling the MDrive after initial TCP/IP configuration.

6.2.1 Installation

System requirements

- IBM Compatible PC.
- Windows XP Service Pack 2 or greater.
- Ethernet hub with free port.

Installation

- 1) Download the software from the web site at http://motion.schneider-electric.com/downloads/software_interfaces.html.
- 2) Extract to a location on your hard drive.
- 3) In the folder location of the extracted files, double click “setup.exe”
- 4) Follow the on-screen prompts to complete the installation.

6.2.2 Screen overview

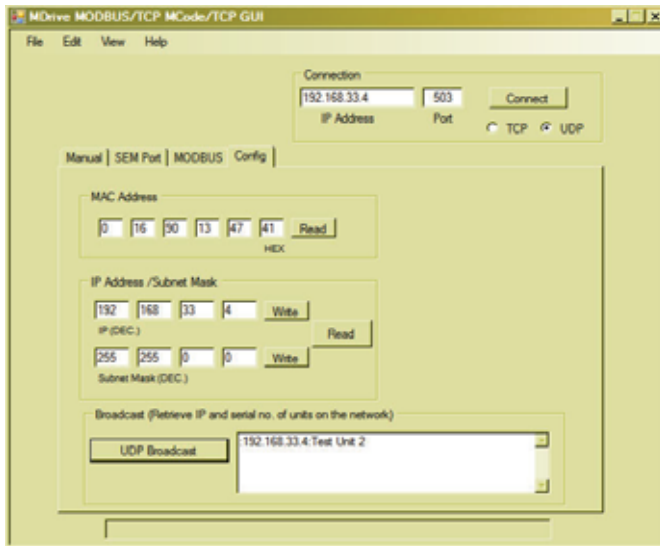

Configuration

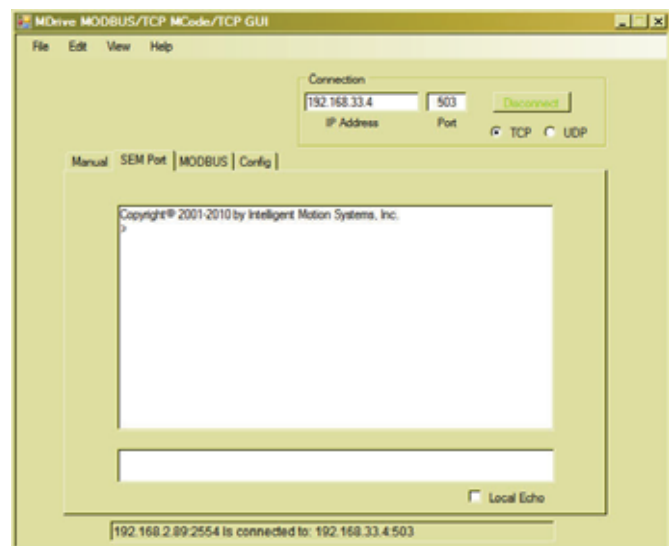

SEM Port (Terminal)

Figure 6.3 TCP/IP Configuration Utility

For MCode/TCP two of the 4 tabs on the GUI are available: The MODBUS and Manual tabs will generate an error dialog if you attempt to access them in MCode/TCP mode.

1. Config: Used to read the device MAC address and read/write the IP address and netmask.
2. SEM Port: a lightweight terminal emulator for testing the communication setting.

6.2.3 Configuration

The primary function of the utility in MCode/TCP mode is to configure the device IP address and Subnet Mask.

If you are on a corporate network, you may need to check with your IT department to obtain a block of private IP addresses so as not to conflict with computers and other devices on the network.

The assigned IP address should always be within the IPv4 Private Network block (192.168.0.0 — 192.168.255.255).

MCode/TCP will always use port 503 and may communicate via TCP or UDP interchangeably.

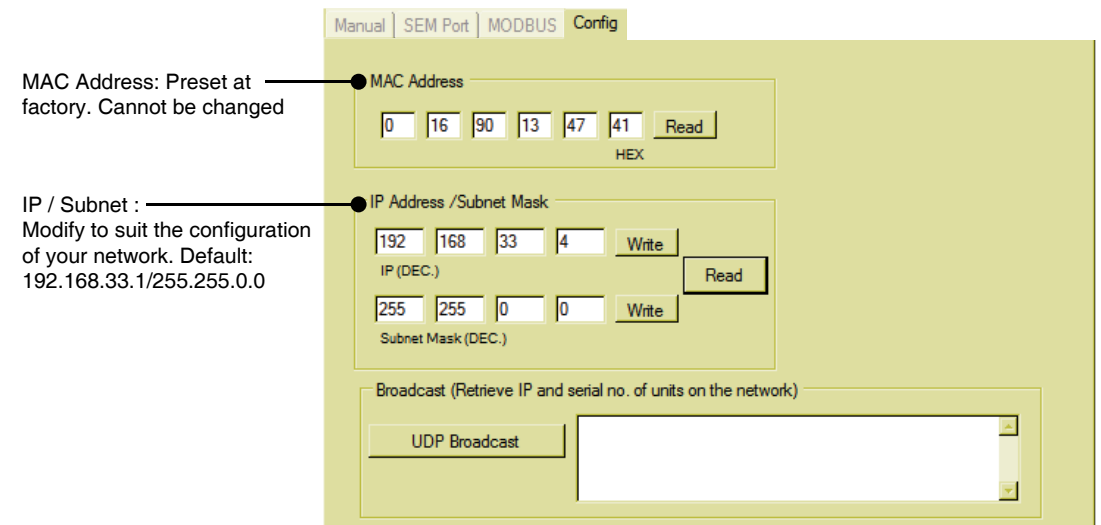

Figure 6.4: Configuration tab

6.2.4 SEM Port tab

This tab is used to test the functionality of communication interface and can submit commands to the MDrive

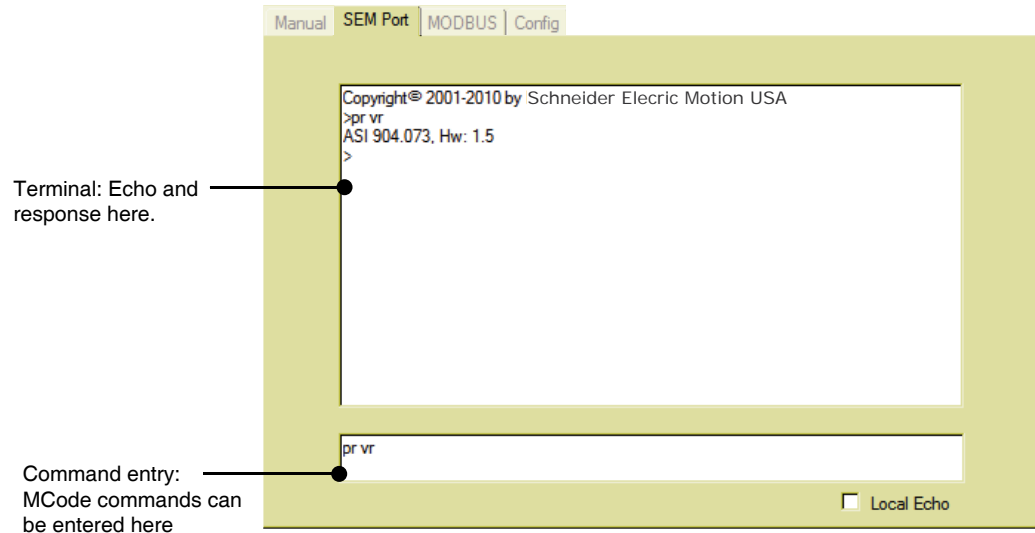

Figure 6.5: SEM Port tab

6.3 Upgrading the Ethernet controller firmware

NOTE: This refers strictly to the controller firmware for the Ethernet interface of Ethernet equipped MDrivePlus and MDrive Hybrid models. It is NOT an upgrade to the MDrive operating firmware.

It is recommended that you DO NOT perform this upgrade unless so instructed by the IMS SEM Applications department.

Please review this in detail before performing the upgrade, each step must be completed in order.

Requirements

The latest versions of the software and firmware are available on the web site under the downloads tab at <http://www.schneider-electric-motion.us>

- 1) MDrivePlus or MDrive Hybrid Motion Control with Ethernet
- 2) TCP/IP Configuration Tool (Installed)
- 3) TFTP Server (Installed)
- 4) Ethernet firmware upgrade file
 IMPORTANT: Unzip upgrade *.S19 file to the installation directory of the TCP/IP Configuration Tool

This process will utilize the firmware upgrade area on the configuration tab of the TCP/IP Configuration Tool to set up.

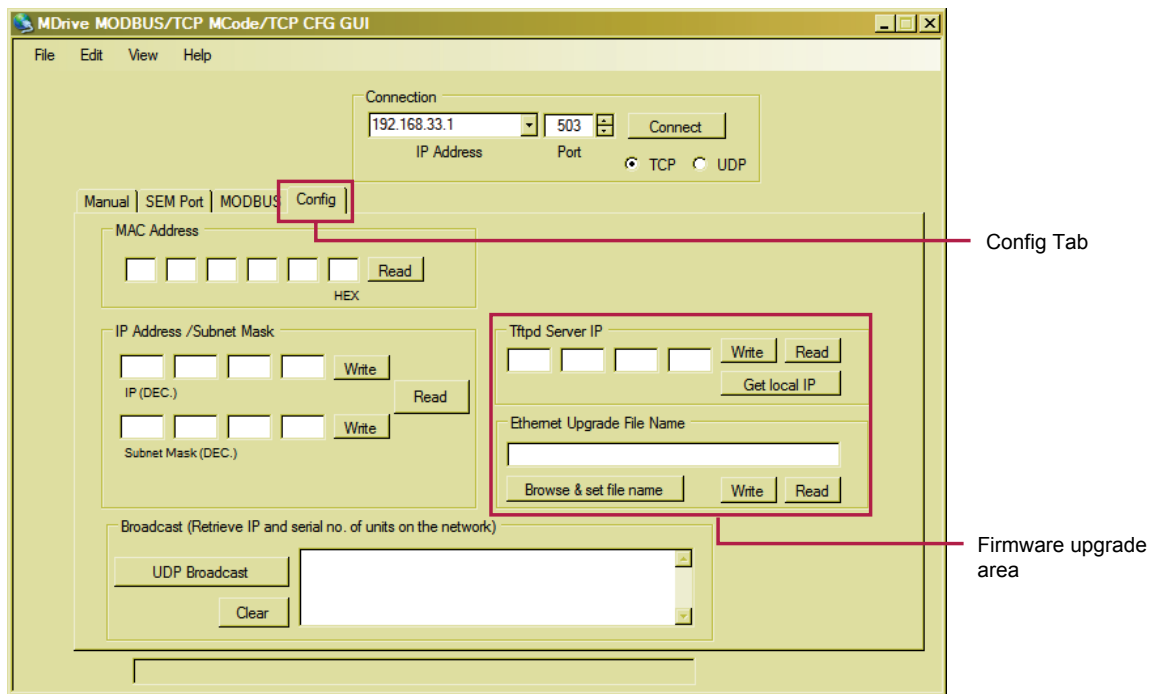

Figure 6.6: TCP/IP Config tab

6.3.1 To begin

- 1) Open the TCP/IP Configuration Tool
- 2) Click the config tab, if not already active.
- 3) Connect to your Ethernet MDrive over TCP.

6.3.2 Set the Tftpd Server IP

- a) Click "Get Local IP"
- b) Click "Write"
- c) Tftpd Server IP should read 'OK'

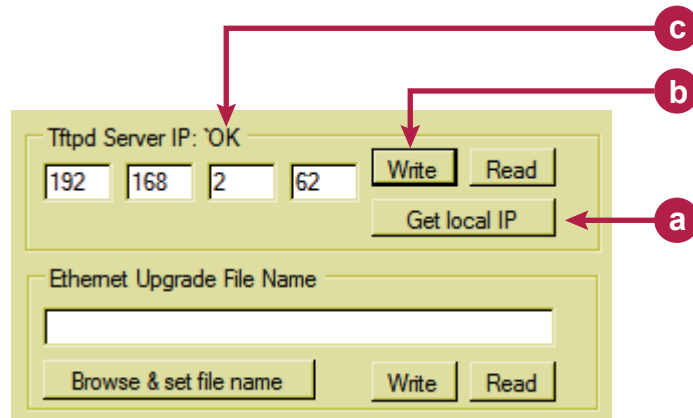

Figure 6.7: Setting the Tftpd Server IP

6.3.3 Set the Ethernet upgrade file name

- a) Click "Browse & set file name". In the file open window, browse to the location where you extracted the firmware upgrade *.S19 file. Click "OK"
- b) Click "Write"
- c) Ethernet Upgrade File Name should read '~OK'

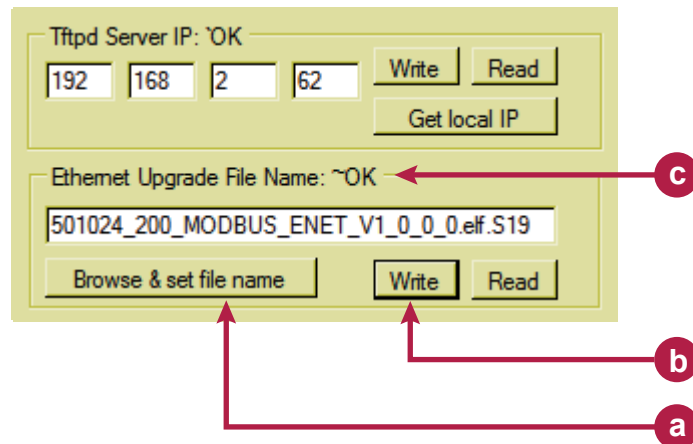

Figure 6.8: Setting the upgrade file name

6.3.4 Enter upgrade mode

- 1) On the «Edit» menu, select «Enter Ethernet Firmware Upgrade Mode»
- 2) A dialog will open requesting verification of the upgrade file-name. If the name matches, click «Yes».
- 3) If it does not match, click «No» and repeat step 2.
- 4) In the dialog, «Enter unlock code to enter upgrade mode», enter the code:

2956102
- 5) The message, «Successfully entered Ethernet Firmware upgrade mode» will appear, click «OK».
- 6) The message «Cycle power to upgrade Ethernet firmware via Tftpd server» will pop up. DO NOT Click OK at this point.

6.3.5 Complete upgrade process

- 1) Remove power from you MDrive.
- 2) Click “OK” on the dialog referenced in Step 3-e.
- 3) On the “Edit” menu, select “Select & Enter Tftpd Server”. The browse dialog should open to the install directory. If not, browse to the Tftpd_Server install directory and select “tftpd32.exe”
- 4) Click “Open”
- 5) Apply power to the MDrive
- 6) The upgrade should begin after a few seconds.
- 7) When complete, close Tftpd server.
- 8) Cycle power to the MDrive.
- 9) Reconnect using the default IP: 192.168.33.1 and Subnet mask: 255.255.0.0.
- 10) Configure device to your system requirements.

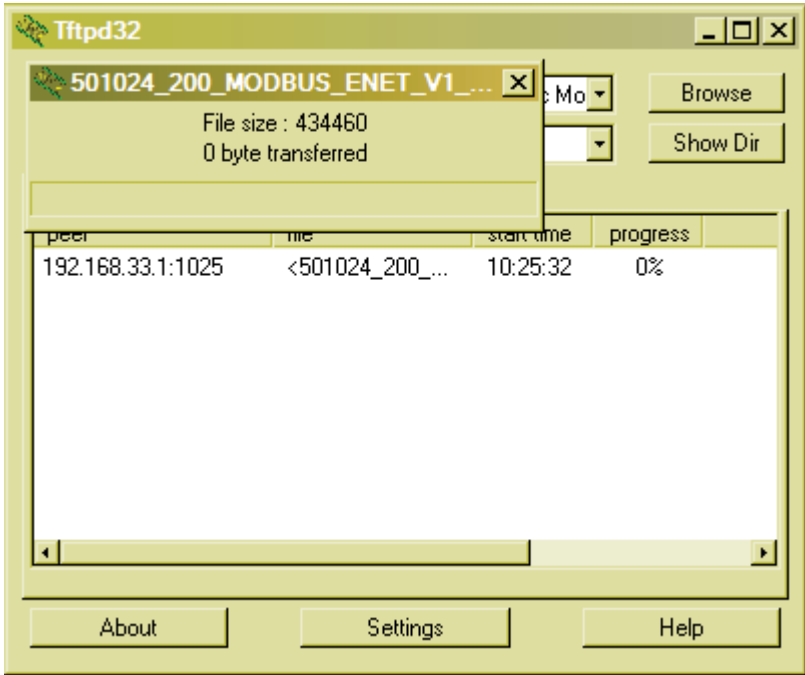

Figure 6.9: Firmware upgrading

7 Programming and application notes

This section will cover the following areas of MCode programming and applications in detail.

- Party mode communications
- Programming the I/O
- Factors impacting motion commands
- MForce PWM configuration

7.1 Party mode communications

The following communication formats, used by MCode compatible devices.

{ } The contents between the { } symbols are transmitted.
 {0D} Hex equivalent for a CR (Carriage Return).
 {0A} Hex equivalent for a LF (Line Feed).
 {DN} Represents the Device Name being sent.
 {CS} Check Sum; {ACK} 06 Hex; {NAK} 15 Hex
 EM = Echo Mode; PY = PartY Mode; CK= Check sum

The word {command} represents the immediate command sent to the device.

Command execution time (CET) is the time the device takes to execute a command. This varies from command to command and usually is in the 1-5 millisecond range.

7.1.1 Response to Echo Mode

Dependent on how the echo mode (EM) is set in conjunction with party mode (PY) and check sum (CK), the device will respond differently. The following tables illustrate the various responses based on how the EM, PY and CK parameters are set.

Parameter Setting	Transmission	Initial Response	Final Response	Notes
EM=0 & PY=0 CK=0	(command) (D)	(command) Echoed back one character at a time as the character is entered.	CET (0D) (0A)>	The last character sent is the prompt >
EM=1 & PY=0 CK=0	(command) (0D)	-	CET (0D) (0A)	The last character sent is LF
EM=2 & PY=0 CK=0	(command) (0D)	-	-	No response except to PR and L commands
EM=3 & PY=0 CK=0	(command) (0D)	-	CET command (0D) (0A)	Queued response. The last character sent is the LF

Table 7.1 Response to echo mode - party and check sum are zero (0)

Parameter Setting	Transmission	Initial Response	Final Response	Notes
EM=0 & PY=1 CK=0	(DN) (command) (0A)	(command) Echoed back one character at a time as the character is entered.	CET (0D) (0A)>	The last character sent is the prompt >
EM=1 & PY=1 CK=0	(DN) (command) (0A)	-	CET (0D) (0A)	The last character sent is LF
EM=2 & PY=1 CK=0	(DN) (command) (0A)	-	-	No response except to PR and L commands

EM=3 & PY=1 CK=0	(DN) (command) (0A)	-	CET command (0D) (0A)	Queued response. The last character sent is the LF
---------------------	------------------------	---	--------------------------	---

Table 7.2 Response to echo mode - party is one (1) and check sum is zero (0)

Parameter Setting	Transmission	Initial Response	Final Response	Notes
EM=0 & PY=0 CK=1	(DN) (command) (0A)	(command) Echoed back one character at a time as the character is entered.	CET (0D) (0A)>	The last character sent is the prompt >
EM=1 & PY=0 CK=1	(DN) (command) (0A)	-	CET (0D) (0A)	The last character sent is LF
EM=2 & PY=0 CK=1	(DN) (command) (0A)	-	-	No response except to PR and L commands
EM=3 & PY=0 CK=1	(DN) (command) (0A)	-	CET command (0D) (0A)	Queued response. The last character sent is the LF

Table 7.3 Response to echo mode - party is zero (0) and check sum is one (1)

Parameter Setting	Transmission	Initial Response	Final Response	Notes
EM=0 & PY=1 CK=1	(DN) (command) (CS) (0A)	(command) Echoed back one character at a time as the character is entered.	CET (ACK) or (NAK)>	The last character sent is the prompt >
EM=1 & PY=1 CK=1	(DN) (command) (CS) (0A)	-	CET (ACK) or (NAK)>	The last character sent is ACK or NAK
EM=2 & PY=1 CK=1	(DN) (command) (CS) (0A)	-	-	No response except to PR and L commands
EM=3 & PY=1 CK=1	(DN) (command) (CS) (0A)	-	CET command (CS) (ACK) (NAK)	Queued response. The last character sent is ACK or NAK

Table 7.4: Response to echo mode - party and check sum are one (1)

7.1.2 Using Check Sum

For communication using check sum, the following 2 commands demonstrate sending and receiving.

- 1) Check sum set to zero before first character is sent.
- 2) All characters (ascii values) are added to check sum, including the device name DN (if PY=1), to the end of the command, but not including terminator.
- 3) Check sum is 2's complement, then "or" ed with hex 80 (prevents check sum from being seen as command terminator).
- 4) Terminator sent.

Note: Any combination of upper/lower case may be used. In this example, if a lower case <mr> were to be used, the decimal values will change to 109 and 114. Subsequently the result check sum value will change. (Possible entries: MR, mr, Mr, mR.) (M = 77, R = 82, m = 109, r = 114) (See ASCII table in Section 9 of this document.)

```

77 82 32 49   Decimal value of M, R, <space> and 1
4D 52 20 31   Hex
77+82+32+49 = 240      Add decimal values together
1111 0000 = 240      Change 240 decimal to binary
0000 1111 1's complement (invert binary)
0001 0000 Add 1 [2's complement]
1000 0000 OR result with 128 (Hex 80)
1001 0000 144      Result Check Sum value

```

Once the result is reached, add the check sum value (144 in this example) to your string by typing: MRr 1(alt key + 0144) (use the symbol of 0144 in your string by holding down the alt key and typing 0144). You must type the numbers from the numlock key pad to the right of the keyboard. The numbers at the top of the keyboard will not work.

- 1) Check sum set to zero.
- 2) All characters are added to check sum.
- 3) When receiving a command terminator, the lower 7 bits of the check sum should be equal to zero.
 - A) if not zero, the command is ignored and NAK echoed.
 - B) if zero, ACK is sent instead of CR/LF pair.
- 4) Responses to PR commands will be check summed as above, but the receiving device should not respond with ACK or NAK.

7.1.3 Immediate party mode sample codes

Once party mode has been defined and set up as previously described under the heading "multiple devices (party mode)", you may enter commands in the immediate mode in the ims terminal window. Some examples follow.

Move device A, B or C 10000 steps

Assuming there are three devices set up in party mode as shown in the sample codes above.

- To move mdrive unit “a”, press CTRL+J and then type: aMR^10000 and press CTRL+J. device “a” will move 10000 steps.
- To print the position type: aPR p and press CTRL+J. The position of device “a” will be printed.
- To move device “b” type: bMR 10000 and press CTRL+J. Device “b” will move 10000 steps.
- To move all three devices at the same time type: *MR 10000 and press CTRL+J. All devices will move 10000 steps.
- To change a variable in the “c” unit type: c<variable name><number> and press CTRL+J. The variable will be changed. To verify the change type: cPR <variable name> and press CTRL+J. The new value will be displayed.
- All commands and variables may be programmed in this manner.
- To take a device out of party mode type: <device name>PY=0 and press CTRL+J. That unit will be taken out of party mode. To take all units out of party mode type: *PY=0 and press CTRL+J. All units will be taken out of party mode.

7.2 Programming the I/O

7.2.1 I/O availability per device type

The product families using the MCode language may have different sets of I/O points and functions. These are

MDrive, MForce

- 4 +5 to +24 VDC I/O points programmable as sinking or sourcing inputs or sinking outputs.
- 1 analog input.

MDrive, MForce, (Plus² expanded features)

- 8 +5 to +24 VDC I/O points programmable as sinking or sourcing inputs or outputs.
- 1 analog input.
- 2 TTL level step/direction I/O programmable as sinking or sourcing inputs or outputs.
- 1 TTL level high speed point programmable for capture input or trip output functions

MDrive, MForce (Plus² expanded features with remote encoder inputs)

- 4 +5 to +24 VDC I/O points programmable as sinking or sourcing inputs or outputs.
- 1 analog input.

- 6 TTL level differential encoder inputs.
- 1 TTL level high speed point programmable for capture input or trip output functions.
- **EXCEPTION:** MDrive34Plus² and MForce PowerDrive Plus² are available with 8 sinking/sourcing I/O points and remote encoder inputs.

MDrive Hybrid

- 8 +5 to +24 VDC I/O points programmable as sinking or sourcing inputs or outputs.
- 1 analog input.
- 1 TTL level high speed point programmable for capture input or trip output functions

7.2.2 Active states defined

The active state determines at what voltage level the input will be active.

Active HIGH: the input will be active when +5 to +24 VDC is applied to the input.

Active LOW: The input will be active when it is grounded (0 VDC).

Examples

IO 1 is to be configured as a Jog- input which will activate when a switch is toggled to ground (sinking input):

```
S1=8,0,0 `set io point 1 to jog-, active low, sinking
```

IO 4 is to be configured as a home input which will activate when instructed by a PLC (+24VDC sourcing input):

```
S4=1,1,1 `set io point 1 to home, active high, sourcing
```

7.2.3 Digital input functions

The inputs may be interfaced to a variety of sinking or sourcing devices. An input may be programmed to be a general purpose user input, or to one of nine dedicated input functions. These may then be programmed to have an active state of either high or low.

The inputs are configured using the “S” variable (see Section 5: Command details). The command is entered into the ims terminal or program file as:

```
s<io point>=<io type>,<active state><sink/source>.
```

Example:

```
S9=3,1,0 `set io9 = limit- input, active high, sinking
S3=0,0,1 `set io 3 = general purpose input, active low,
`sourcing
```

Input Functions (I/O Points 1-4, 9-12) The following table lists the programmable input functions.

Function	Description	Parameter (S1-S4, S9-S12)	Active	Sink/Source
General Purpose	General purpose input function used to control program branches, subroutine calls or bcd functions when input bank is used as a group	0	0/1	0/1
Home	Homing input. Will function as specified by the home (hm) command.	1	0/1	0/1
Limit +	Positive limit input. Will function as specified by the limit (lm) command.	2	0/1	0/1
Limit –	Negative limit input. Will function as specified by the limit (lm) command.	3	0/1	0/1
G0	G0 input. Will run program located at address 1 on activation.	4	0/1	0/1
Soft Stop	Soft stop input. Stops motion with deceleration and stops program execution.	5	0/1	0/1
Pause	Pause/resume program with motion.	6	0/1	0/1
Jog +	Will jog motor in the positive direction at max. Velocity (vm). The jog enable (je) flag must be set for this to function.	7	0/1	0/1
Jog –	Will jog motor in the negative direction at max. velocity (VM). The jog enable (JE) flag must be set for this to function.	8	0/1	0/1
Reset	When set as reset input, then the action is equivalent to a ^c entered into a terminal.	11	0/1	0/1

Table 7.5 Digital input functions

Input Functions (Points 7 & 8 — Clock Inputs and Point 13 — Capture)

Function	Description	Parameter (S7, S8)	Active
Step/Direction	Sets IO 7 and 8 to receive step and direction inputs from an external source. The motion will occur based on the input frequency seen at IO 7 in the direction relative to the logic state of IO 8. The step rate will be based upon the ratio set by clock ratio (cr)	33	0/1
Quadrature	Sets IO 7 and 8 to receive channel a and channel b quadrature inputs from an external source such as an encoder. The motion will follow the quadrature input.	34	0/1
Up/Down	Sets IO 7 and 8 to receive clock up/clock down inputs from an external source. The motion will occur based upon the input clock frequency in the direction relative to the input being clocked. The step rate will be based upon the ratio set by clock ratio (CR)	35	0/1
Function	Description	Parameter (S13)	Active
High Speed Capture	The capture input is a momentary high speed input that operates with the trip capture (TC) variable to run a subroutine upon the trip. It feature variable input filtering ranging from 50 ns to 12.9 Ms	60	0/1

Table 7.6 Clock and high speed input functions

7.2.4 Digital output functions

The outputs may be configured as general purpose or set to dedicated functions, fault or moving. These outputs will sink up to 600 mA (one channel of two banks) and may be connected to an external VDC source.

The outputs are set using the “S” command (see Section 5 of this document for precise details on this command). The command is entered into the terminal or program file as:

Examples

```
S<IO point>=<IO Type>,<Active State><Sink/Source>.
```

```
S9=17,1,0 `set IO point 9 to be a moving output, active
           `high, sinking
S3=18,0,0 `set IO point 3 to be a fault output, active
           `low, sinking
```

Output Functions

Output functions may be programmed to be a general purpose user output with the following functions.

Function	Description	Parameter (S1-S4, S9-S12)	Active	Sink/ Source
General Purpose User	A general purpose output can be set in a program or in immediate mode to trigger external events. When used as a group they can be a BCD output.	16	0/1	0/1
Moving	Will be in the active state when the motor is moving.	17	0/1	0/1
Fault	Will be in the Active State when a error occurs. .	18	0/1	0/1
Stall	Will be in the active state when a stall is detected. Encoder required, stall detect mode (SM) must be enabled.	19	0/1	0/1
Velocity Changing	Will be in the active state when the velocity is changing. Example: during acceleration and deceleration.	20	0/1	0/1
*Locked Rotor	Will be in an active state when the rotor is locked on MDrive Hybrid products	21	0/1	0/1
Moving to Position	Will be active when the motor is indexing to a commanded position.	22	0/1	0/1
*Hybrid Active	Will be active when the Hybrid control circuitry is engaged.	23	0/1	0/1
*Make Up Active	Will be active when the Hybrid is correcting lead/lag conditions.	24	0/1	0/1

*Only applies to Hybrid products.

Table 7.7 Digital output functions

Output Functions (Points 7 & 8 — Clock Outputs and Point 13 — Trip)

Function	Description	Parameter (S7, S8)	Active
Step/Direction	Step clock pulses will be output from point 7, direction from point 8. The step clock output rate will be based upon the pulse width set by clock width (CW). The logic state of the direction output will be with respect to the direction of the motor.	49	0/1
Quadrature	Will output Quadrature signals.	50	0/1
Up/Down	Will output clock up/clock down signals. The step clock output rate will be based upon the pulse width set by clock width (CW). The active output will be based on the motor direction.	51	0/1
Function	Description	Parameter (S13)	Active
High Speed Trip	The trip output will activate on position trips (TP) only. The output will pulse out at the trip point. The pulse width will be determined by clock width (CW)	61	0/1

Table 7.8 Clock and high speed output functions

7.2.5 Programmable I/O usage examples

The code examples below illustrate possible interface examples for using the digital I/O.

Reference the hardware manual of your device for connection and wiring information

Input Interface Example - Switch Input (Sinking Input)

Compatible with Motion Control products:
 MDrive
 MDrive (Plus² expanded features)
 MDrive Hybrid
 MForce
 MForce (Plus² expanded features)

The following example shows a switch connected between an I/O point and power ground.

Code Sample

For the code sample, this switch will be set up as a G0 sinking input, active when low. When pressed, the switch will launch the program beginning at address 1 in device memory:

```

***Setup Variables***
Sx=4,0,0 `set IO point x to be a G0 input, active when
        `LOW, sinking

****Program***
PG1
MR 20000 `Move +20000 steps relative to current
position
H        `Hold program execution until motion completes
MR -20000 `Move -20000 steps
H        `Hold program execution until motion completes
E
PG        `End program, exit program mode

```

Input interface example - switch input example (sourcing input)

Compatible with Motion Control products:
 MDrive
 MDrive (Plus² expanded features)
 MDrive Hybrid
 MForce
 MForce (Plus² expanded features)

The following circuit example shows a switch connected between an I/O point and a voltage supply which will source the input to perform a function.

Code Sample

For the code sample, the switch will be set up as a soft stop sourcing input, active when high. When pressed, the switches will stop the motor.

```
S1=5,1,1  `set IO point 1 to be a Soft Stop input, active
          `when HIGH, sourcing
SL 200000 `slew the motor at 200000 μsteps/sec
```

When the switch is depressed the motor will decelerate to a stop.

Output interface example (sinking output)

Compatible with Motion Control products:
 MDrive
 MDrive (Plus² expanded features)
 MDrive Hybrid
 MForce
 MForce (Plus² expanded features)

The following circuit example shows a load connected to an I/O point that will be configured as a sinking output.

For the code sample, the load will be an LED. The motor is configured such that the LED will be lit while the motor is at constant velocity. Set input 1 up to be a soft stop input using a switch in a sinking configuration this will soft stop the motor.

```
S1=5,0,0  `set IO point 1 to be a Soft Stop input, active
          `when LOW, sinking.
S1=20,0,0 `set IO point 2 to be a Velocity Changing
          `output, active when LOW
SL 2000000 `slew the motor at 200000 μsteps/sec
```

While the motor is accelerating the LED will be dark, but will light up when the motor reaches a constant velocity. When the Soft Stop switch is depressed the motor will begin to decelerate, the LED will go dark again while velocity is changing.

Output interface example (sourcing output)

Compatible with Motion Control products:
 MDrive (Plus² expanded features)
 MDrive Hybrid
 MForce (Plus² expanded features)

The following circuit example shows a load connected to an I/O point that will be configured as a sourcing output.

Code Sample

For the code sample, the load will be a relay. The output will be configured to be a general purpose user output that will be set active when a range of motion completes.

```
*****Setup Variables*****
S1=16,1,1 `set IO 1 = user output, active HIGH, sourcing.

*****Program*****
PG 100      `Enter program at address 100
MR 2000000 `Move x in the positive direction
H          `Hold execution until motion completes
MR -1000000 `Move x distance negative direction
H          `Hold execution until motion completes
O1=1      `Set output 1 HIGH
```

Enter EX 100 to execute the program, the motion will occur and the output will set high.

Reading inputs as a group example

Compatible with Motion Control products:
 MDrive
 MDrive (Plus² expanded features)
 MDrive Hybrid
 MForce
 MForce (Plus² expanded features)

The inputs may read as a group using the IL, IH and IN keywords. This will display as a decimal between 0 to 15 representing the 4 bit binary number (IL, IH) or as a decimal between 0 and 255 representing the 8 bit binary number on the devices with expanded I/O. The IN keyword will function on the devices with standard I/O but will only read inputs 1 - 4. Inputs will be configured as user inputs (S<point>=0).

Standard I/O

```
PR IN      `Reads Inputs 4(MSB) through 1(LSB)
PR IN      `Reads Inputs 4(MSB) through 1(LSB)
```

Expanded I/O

```
PR IL      `Reads Inputs 4(MSB) through 1(LSB)
PR IH:     `Reads Inputs 12(MSB) through 9(LSB)
PR IN:     `Reads Inputs 12(MSB) - 9 and 4 - 1(LSB)
```

Interfacing outputs as a group example

Compatible with Motion Control products:
 MDrive
 MDrive (Plus² expanded features)
 MDrive Hybrid
 MForce
 MForce (Plus² expanded features)

Outputs may be written to as a group using the OL, OH and OT keywords. This will set the outputs as a binary number representing the decimal between 0 to 15 representing the 4 bit binary number (OL, OH) or as an 8 bit binary number representing the decimal 0 to 255 on texpanded I/O devices. The OT keyword will function on tstandard I/O devices, but will only set outputs 1 - 4. Outputs will be configured as user outputs (S<point>=16).

Standard I/O

```

OL=3           `set the binary state of the standard
I/O to 0011
OT=13         `set the binary state of the standard
I/O to 1101
    
```

Expanded I/O

```

OL=5           `set the binary state of the standard
I/O to 0101
OH=9           `set the binary state of the expanded
I/O to 1001
OT=223        `set the binary state of the combined I/O to
1101 1111
    
```

7.2.6 Dedicated digital I/O usage

Compatible with Motion Control products:
 MDrive (Plus² expanded features)
 MForce (Plus² expanded features)

These dedicated I/O lines are used to receive clock inputs from an external device or provide clock outputs to an external device such as a counter or a second device in a system. The clock I/O can be configured as one of three clock types using the S7 and S8 variable:

- 1) Step/Direction
- 2) Quadrature
- 3) Up/Down

Step/Direction

The Step/Direction function would typically be used to receive step and direction instructions from a second system device or secondary controller. When configured as outputs the device can provide step and direction control to another system drive for electronic gearing applications.

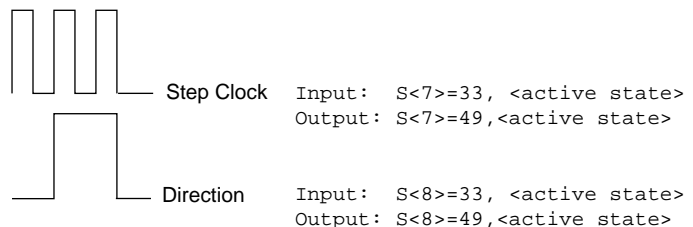

Figure 7.1 Step/direction I/O type & configuration

Quadrature The quadrature clock function would typically be used for following applications where the device would either be a master or slave in an application that would require two motors to move the same distance and speed.

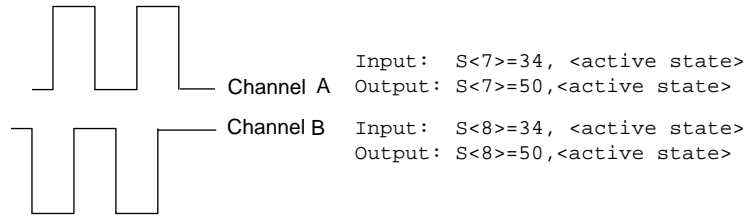

Figure 7.2 Quadrature I/O configuration

CW/CCW The cw/ccw clock would typically be used in a dual-clock direction control application, or to increment/decrement an external counter.

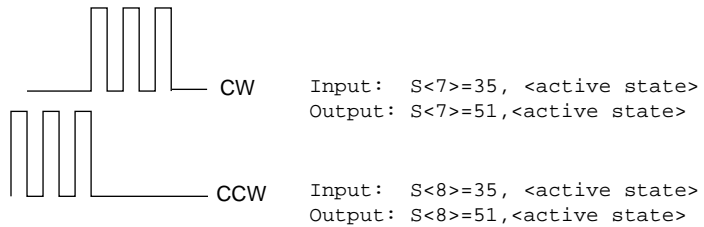

Figure 7.3 CW/CCW I/O configuration

7.2.7 Analog input usage

Compatible with Motion Control products:
 MDrive
 MDrive (Plus² expanded features)
 MDrive Hybrid
 MForce
 MForce (Plus² expanded features)

The analog input is configured from the factory as a 0 to 5V, 10 bit resolution input (S5=9). This offers the user the ability to receive input from temperature, pressure, or other forms of sensors, and then control events based upon the input.

The value of this input will be read using the I5 instruction, which has a range of 0 to 1023, where 0 = 0 volts and 1024 = 5.0 volts. The analog input may also be configured for a 4 to 20 mA or 0 to 20 mA Analog Input (S5 = 10). If used as a 4 to 20mA input the range is 0 to 800 units.

Sample Usage

```

\*****Main Program*****

S5=9,0          `set analog input to read variable
                `voltage (0 to +5VDC)
PG 100          `start prog. address 100
LB A1           `label program A1
CL A2, I5<500   `Call Sub A2, If I5 is less than 500
CL A3, I5>524   `Call Sub A3, If I5 is greater than 524
BR A1           `loop to A1

\*****Subroutines*****

LB A2           `label subroutine A2
MA 2000        `Move Absolute 2000 steps
H              `Hold program execution until motion ceases
RT            `return from subroutine

LB A3           `label subroutine A3
MA -2000       `Move Absolute -2000 steps
H              `Hold program execution until motion ceases
RT            `return from subroutine
E              `End
PG            `Exit program

```

7.3 Factors impacting motion commands

7.3.1 Motor steps

All MCode examples assume 200 step motors. They rotate at 1.8° per clock pulse. 200 steps would equal 1 revolution. MCode devices such as the MForce line may be used with different step resolution motors, such as 0.9° motors.

7.3.2 Microsteps: (MS)

Microsteps divide the 200 motor steps into smaller steps to improve smoothness and resolution of the MCode compatible device. Using the default setting of 256 for MS, the 200 motor steps are increased to 51200 microsteps. One motor revolution requires 51200 microsteps with the ms set at 256. If you were to set the ms to 128, one revolution of the motor would now require 25600 microsteps.

7.3.3 Move Command

The move absolute (MA) and the move relative (MR) commands are programmed in microsteps or if the encoder is enabled, encoder counts. If the ms was set at 256 and you were to program a move of 51200 microsteps, the motor would turn one full revolution. If the ms was set to 128, one full revolution of the motor would be 25600 microsteps (128 x 200). If you programmed a move of 51200, the motor would turn 2 full revolutions.

7.3.4 Closed loop control with an encoder

If the encoder is enabled the move commands use different values. The encoder has 512 lines and yields 2048 counts or counts per revolution. Therefore, the MR and MA command values are programmed in encoder counts. One full revolution would be programmed as mr or ma 2048.

When the encoder is enabled, the MS value is defaulted to 256. It cannot be changed.

Knowing these factors you can program a multitude of different movements, speeds, and time intervals.

7.3.5 Linear movement

You have a rack and pinion or a ball screw to move a linear axis. The rack and pinion or ball screw moves the linear axis 0.1 inches for each revolution. You need to move 7.5 inches.

7.5 inches divided by 0.1 inches = 75 motor revolutions.

Assuming an MS of 256 (51200 Microsteps) is programmed, 51200 Microsteps x 75 revolutions requires a move of 3840000 microsteps.

Knowing the values of the variables as well as the required move, you can calculate the actual time it takes to move the axis the required distance. This is done with a trapezoidal profile as shown below.

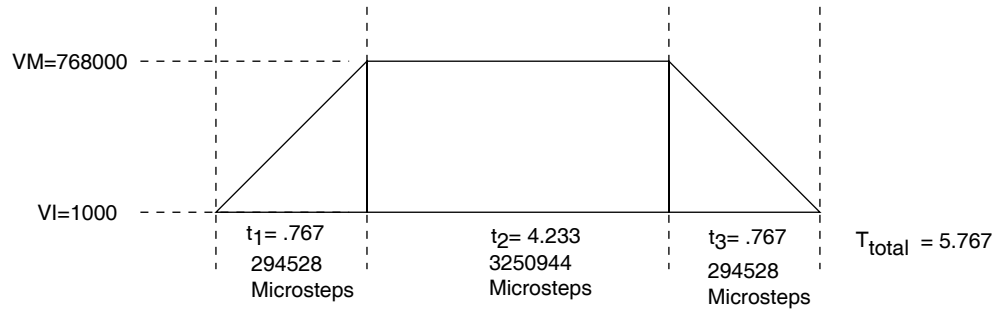

Figure 7.4 Trapezoidal move profile

Calculating axis speed (velocity)

There are several steps required to determine the actual axis speed. They are all based on the Trapezoidal Profile above.

Known Values and Parameters:

VM.....768000 Steps/Sec.

VI..... 1000 Steps/Sec.

A..... 1000000 Steps/Sec².

D 1000000 Steps/Sec².

MA/MR.....3840000 Microsteps

Determine the Acceleration (A) and Deceleration (D) times (t1 and t3). Since the Deceleration (D) value is also 1000000 Steps/Sec. the Deceleration time (t3) will be the same as the Acceleration time (t1).

$$(t1 \text{ and } t3) = \frac{VM - VI}{A} \text{ OR } \frac{768000 - 1000}{1000000} = 0.767 \text{ Seconds}$$

Determine the distance (Steps) traveled in t1 or t3.

$$\text{Distance} = \frac{VM + VI}{2} \times t1 \quad \text{OR} \quad \frac{768000 + 1000}{2} \times 0.767$$

$$= 294911 \text{ steps}$$

Determine the t2 time.

The t2 time is calculated by dividing the remainder of MA/MR by VM.

The remainder of MA/MR = MA/MR - (t1 steps + t3 steps) or 3840000 - 589056 = 3250944.

$$t2 = \frac{3250944}{768000} = 4.233 \text{ Seconds}$$

Determine the total time. (t1 + t2 + t3) or (0.767 + 4.233 + 0.767) = 5.767 Seconds

The linear axis took 5.767 seconds to move 7.5 inches or an average speed of 78 inches/minute.

Note that the average speed includes the Acceleration and Deceleration. The maximum axis speed attained is approximately 90 inches/minute.

$$\frac{768000}{51200} \times 0.1 \times 60 = 90 \text{ IPM}$$

7.3.6 Calculating rotary movement

Assume the MS is set to 256. You are using the motor to drive a shaft with a timing belt and pulley arrangement. As shown below, the pulley is 1" in diameter and the shaft pulley is 2.5" in diameter. You must turn the shaft 270°.

- The shaft will rotate 1 full revolution for every 2.5 revolutions of the motor.
- 270° is 0.75 of a revolution.
- $0.75 \times 2.5 = 1.875$ motor revolutions to turn the shaft 270°.
- If 51200 Microsteps is 1 motor revolution, then the device must be programmed to move 96000 Microsteps (51200×1.875).

You may also do many of the calculations in reverse to calculate motor moves to meet a required move of your device. A linear or rotational move as well as speed may be translated into an MCode command.

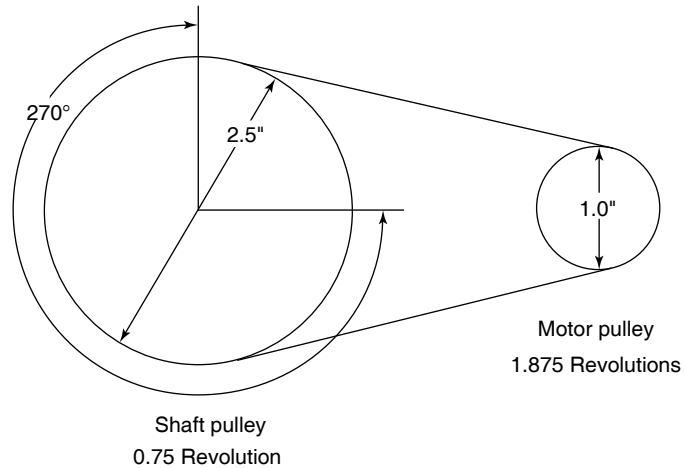

Rotary drive example 1

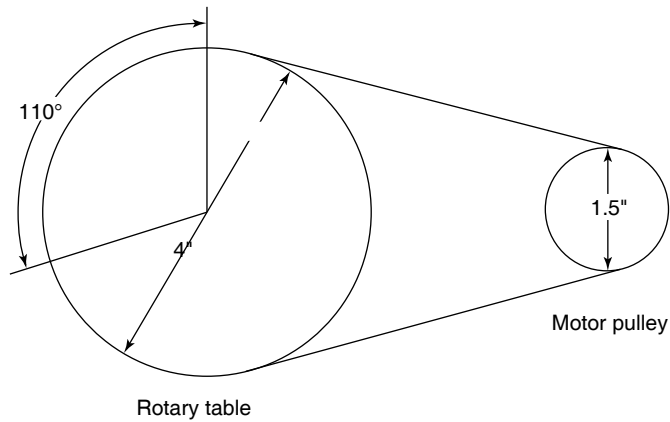

Rotary drive example 2

Figure 7.5 Rotary examples

In the example above, the belt driven rotary table must be turned 110° at 3 RPM. How should the device be set up?

Bear in mind that all the numbers are approximate due to rounding.

Mechanical ratio between the motor and the rotary table is 2.666:1. That is, the motor must rotate 2.666 revolutions for the table to rotate 1 revolution and the table will rotate 2.666 times slower than the motor.

In order to move the table 110° the motor must move 293.3°.

$$110 \times 2.66 = 293.3^\circ$$

If 51200 steps = 1 revolution then 1° = 142.222 steps.

$$\frac{51200}{360} = 142.222 \text{ steps}$$

The MCode device must be programmed to move 41713 steps to rotate 293.3°.

$$142.222 \text{ steps} \times 293.3^\circ = 41713 \text{ steps}$$

In order to rotate the table at 3 RPM the motor must turn at 8 RPM.

$$3 \text{ RPM} \times 2.666 = 8 \text{ RPM}$$

If you were to set VM at 51200 and MS set at 256 the motor will rotate 1 full revolution (51200 steps) in 1 second or 1 RPS. In order to rotate at 8 RPM, the motor must rotate at 0.13333 RPS.

$$\frac{8}{60} = 0.133333 \text{ RPS}$$

In order to rotate at 0.13333 RPS the VM must be set at 6827 steps/sec.

$$51200 \times 0.133333 = 6827$$

$$\text{VM} = 6827$$

Note: These numbers will vary slightly depending on Acceleration and Deceleration rates.

7.3.7 Programming with the optional encoder enabled

An optional 512 line magnetic encoder is available. When the Encoder is enabled (EE=1) the programming also changes. All motion must now be programmed by the encoder counts. The Encoder operates in the “Quadrature” format. That is, there are four Encoder counts for each Encoder line or 2048 counts per revolution ($512 \times 4 = 2048$). (See Figure below.) If you were to program motion using the MR (Move Relative) or MA (Move Absolute) commands the motor would rotate a distance equal to the encoder counts.

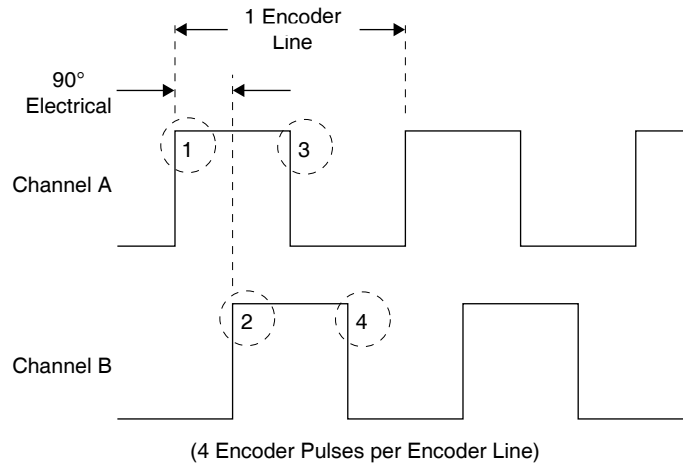

Figure 7.6 Encoder waveform

Example:

A programmed move of 7168 counts would result in the motor rotating 3.5 revolutions at a velocity controlled by VM.

$$7168 \div 2048 = 3.5 \text{ revolutions}$$

If you were to program motion using the SL (Slew) command the motor would rotate at a “counts per second” rate based on the programmed value.

Example:

An SL (Slew) rate of 7168 counts was programmed. The motor will rotate at 7168 counts/sec., 3.5 RPS, or 210 RPM.

$$7168 \div 2048 = 3.5 \text{ RPS} \times 60 = 210 \text{ RPM}$$

When the Encoder is enabled, the parameters are also changed to be compatible with the 2048 counts.

The Encoder Enabled defaults are:

VM..... 30720 Counts/Sec.
 VI..... 40 Counts/Sec.
 A..... 40000 Counts/Sec
 D..... 40000 Counts/Sec.
 MS..... 256 (default for encoder mode.)

To enable the encoder the program syntax is <EE=n> where n is a zero (0) or a one (1). The default is zero (0) which is encoder disabled. To enable the encoder, program EE=1.

Any motion will now be programmed in encoder counts. You can calculate the distance or velocity you need in a similar manner as done previously only with different factors.

Note: The microstep select is defaulted and locked at 256 in the encoder mode to ensure stable, high resolution.

Several Variables work in conjunction with Encoder Enable (EE). They are:

DBEncoder Deadband
 SF..... The Stall Factor Variable
 SM..... The Stall Detection Mode
 ST.....Stall Flag
 PM..... Position Maintenance
 EEEncoder Enabled

When the encoder is enabled, all motion is “closed loop”. That is, motion steps are delivered from the MCode device to the motor which turns the encoder. The encoder sends counts back to the drive to complete the motion. If you programmed a move of 2048 counts, the device would output an appropriate number of microsteps provided the stall factor (SF) value or other fault is not encountered. If no faults were encountered, the device would output the full amount of microsteps. Depending on which variables were set, the driver would then wait until the position (plus or minus the encoder deadband) was read and confirmed.

DB - Encoder Deadband

The Encoder Deadband is a Variable that is set in Encoder Counts. Motion will be deemed complete when the Encoder Counts are within \pm the Deadband variable. With DB=5 the motion of 2048 counts would be complete between 2043 and 2053 counts.

SF - Stall Factor The Stall Factor is a Variable which is entered in Encoder Counts. The Stall Factor is active only in the EE=1 mode. The Stall Factor might be compared to the “following error” or “lag error” of a servo drive. The Stall Factor is triggered by the number of steps output from the device to the motor as compared to the number of counts returned by the encoder. The comparison should always be within the value of the Stall Factor, otherwise a fault will occur and the Stall Flag (ST) will be set. If the Stall Detection Mode is active (SM=0), the motion will be stopped.

Example:

A Stall Factor of 30 counts (SF=30) is programmed. A motion command of 2048 counts is programmed. The device reaches a mechanical bind at 2000 counts. The device will keep outputting steps equivalent to 2030 counts (present position plus the SF value) and then the Stall Flag (ST) will be set. The motor will be stopped if the Stall Detection Mode (SM=0) is active.

SM - Stall Detection Mode The Stall Detection Mode can be programmed to stop the device (SM=0) or to allow the device to continue (SM=1) when the Stall Factor (SF) is reached. Whether SM is active or not, the Stall Flag will always be set when the SF is encountered.

ST - Stall Flag The Stall Flag will be set any time the SF is reached regardless of the state of the Stall Detection Mode (SM). If the Stall Flag is set, the user must reset it to zero (0).

PM - Position Maintenance Position maintenance (PM) is active only after the motion has completed. Position maintenance is used to maintain position when there might be an external force on the drive. If position maintenance is enabled (PM=1) and the stall detection mode is enabled (SM=0), the motor will be driven back to its final position if it was forced out of position provided the stall factor (SF) was not reached.

If position maintenance is enabled (PM=1) and the stall detection mode is disabled (SM=1), the motor will be driven back to its final position if it was forced out of position regardless of whether the stall factor (SF) was reached or not.

There are three other variables, although not directly conned to EE, that do affect the overall operation when in encoder mode, they are:

- HC..... Motor Hold Current
- HT Motor Hold Current Delay Time
- MT.....Motor Settling Delay Time
- HC.....Hold Current

When motion is complete, the device will switch from motor run current (RC) to motor hold current (HC). The hold current is set at a lower percentage than the run current (rc). However, the hold current must be sufficient to overcome an outside force such as driving a vertical slide which maintains a load on the motor at all times. Actual hold current

values will vary depending on the application and the load on the motor when it is at rest.

HT - Motor Hold Current Delay Time

The motor hold current delay time (HT) is a variable that delays the change from run current (RC) to hold current (HC) at the end of a move. The end of the move is triggered by the device when it has completed outputting the correct number of steps. Depending on the application, including velocity, deceleration, load and inertia, the device may lag behind a few counts. The ht will allow the device to finish its move before applying the lower HC.

MT - Motor Settling Delay Time

A stepping motor may ring or oscillate in minuscule amounts at the completion of a move until it satisfies the target position. The amount of this “ringing” is dependent on the application including velocity, deceleration, inertia, friction and load. The motor settling delay time (MT) allows the motor to stop “ringing” before checking the position count. If the device tried to check the position count during this ringing, it would assume a position error and try to correct an already moving motor and possibly cause ringing of a larger magnitude and longevity. Typically, the MT is set between 50 and 100 milliseconds. It is recommended that there is always a Motor Settling Time programmed any time you are in EE=1 mode.

Note: If MT has no value, the motor may hunt and never satisfy the position check.

7.4 MForce PWM configuration

⚠ CAUTION

This variable is only applicable to the mforce product line and is used to tune the PWM Settings to optimize the current control of the MForce driver. It should not be used unless erratic motion or positional accuracy problems are being experienced.

Note that there are other factors that could contribute to these problems. Ensure that all wiring conforms to the guidelines in the mforce hardware manual.

Be aware that this parameter, when used with the checksum will write to the boot sector of memory. This sector only allows eight write cycles. Ensure that the settings you choose are optimal prior to storing the parameter to the boot.

Read this section closely before making changes to the PWM settings. Please contact application support for questions concerning the use of this command.

7.4.1 Description:

This variable defines the parameter settings for the PWM and should not be used unless motion problems such as smoothness and positional accuracy are experienced.

The PW variable consists of four components: <mask>, <period>, <srq> and either <checksum>, if writing, or <boot_writes_remaining> if reading using the PR keyword.

7.4.2 PWM Mask <mask> Parameter

The PWM mask signal prevents the premature end of the forward period caused by switching transients when the motor phase current is at low levels. Adjusting this value can impact the zero-crossing performance of the motor. If experiencing the “tick” which is inherit in stepper motor systems, this may be minimized or eliminated by adjusting this value. The range of this value is 0 to 255d and will be entered as a decimal value.

The Mask will act as a filter on the PWM signal to allow time for any ringing in the output circuitry to settle.

This range represents a 8-bit Hex value that specifies the Bridge Reverse Measure Time (REVTM) and the Minimum Bridge Forward On Time (FORTM) ranging from 600 nS to 3.4 μS each (see table and diagram below). Typically these values would be balanced. The table below shows the decimal value for each time.

Note that these are typical values and the currents may be unbalanced to fine tune the motor performance.

The default value for this parameter is 204 (0xCC), which represents a Reverse Measure Time and Minimum Forward On Time of 2.5 μS.

Hex	Time	Hex	Time	Hex	Time	Hex	Time
0x0	600 ns	0x4	1.0 μs	0x8	1.6 μs	0xC	2.5 μs
0x1	700 ns	0x5	1.1 μs	0x9	1.8 μs	0xD	2.8 μs
0x2	800 ns	0x6	1.2 μs	0xA	2.0 μs	0xE	3.1 μs
0x3	900 ns	0x7	1.4 μs	0xB	2.2 μs	0xF	3.4 μs

Table 7.8 PWM Mask Settings

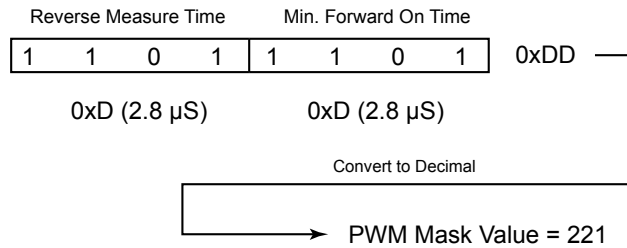

Figure 7.7 PWM mask bits

Mask (hex)	Mask (dec)	REVTM	FORTM	Mask (hex)	Mask (dec)	REVTM	FORTM
0x00	0	600 ns	600 ns	0x88	135	1.6 μs	1.6 μs
0x11	17	700 ns	700 ns	0x99	153	1.8 μs	1.8 μs
0x22	34	800 ns	800 ns	0xAA	170	2.0 μs	2.0 μs
0x33	51	900 ns	900 ns	0xBB	187	2.2 μs	2.2 μs
0x44	68	1.0 μs	1.0 μs	0xCC	204	2.5 μs	2.5 μs
0x55	85	1.1 μs	1.1 μs	0xDD	221	2.8 μs	2.8 μs
0x66	102	1.2 μs	1.2 μs	0xEE	238	3.1 μs	3.1 μs
0x77	119	1.4 μs	1.4 μs	0xFF	255	3.4 μs	3.4 μs

Table 7.9 Typical PWM Mask Settings

7.4.3 Maximum PWM duty cycle (%) <period> parameter

This parameter sets the maximum duty cycle as a percentage of the bridge PWM oscillator period. The range for this parameter is 0 to 95%. Entries above 95% will generate an out of range error (Error 21) and will not allow the setting to be written to the boot.

The default value for this parameter is 95%.

7.4.4 PWM frequency <sfreq> parameter

The PWM Frequency Parameter sets the initial and maximum frequencies for the PWM. As with the MASK parameter, the PWM Frequency is a two part 8-bit hex number which is entered as a decimal value ranging from 0 to 255.

The default for this 170 (0xAA) with an initial PWM Frequency of 20 kHz and a Maximum of 60 kHz.

Hex	Freq.	Hex	Freq	Hex	Freq	Hex	Freq
0x0	40	0x4	48	0x8	56	0xC	64
0x1	42	0x5	50	0x9	58	0xD	66
0x2	44	0x6	52	0xA	60	0xE	68
0x3	46	0x7	54	0xB	62	0xF	70

Table 7.10 Maximum PWM frequency

Hex	Freq.	Hex	Freq	Hex	Freq	Hex	Freq
0x0	10	0x4	14	0x8	18	0xC	22
0x1	11	0x5	15	0x9	19	0xD	23
0x2	12	0x6	16	0xA	20	0xE	24
0x3	13	0x7	17	0xB	21	0xF	25

Table 7.11 Initial PWM frequency

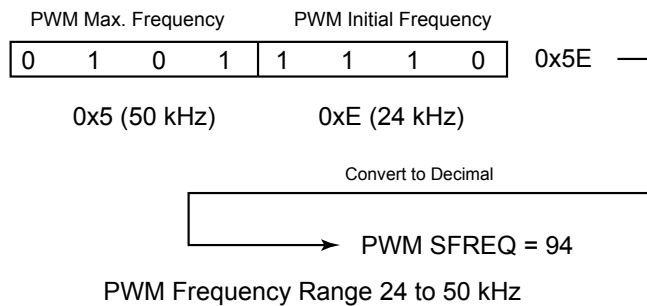

Figure 7.8 PWM frequency range

7.4.5 PWM checksum <chksum> parameter (boot write only)

⚠ CAUTION

This parameter should be left blank for testing parameters. Only insert a checksum if you have verified that these parameters cause the motor to perform as desired as the presence of the checksum WILL write the PWM settings to the boot, Limited Writes (8) are available.

The PWM checksum parameter is only used on the write cycle to write the PWM parameters to the boot. To write the PWM parameters to an Mforce a checksum must be sent along with the parameters.

PW = mask, period, frequency, checksum

To compute the checksum use the following steps:

1. Add the decimal values for mask, period, and frequency. Total = mask + period + frequency
2. Use A, B, or C to calculate checksum
 - A. If the total is less than or equal to 256:
(Total \leq 256) checksum = 256 - Total
 - B. If the total is greater than 256 but less than or equal to 512:
(256 < Total \leq 512) checksum = 512 - Total
 - C. If the total is greater than 512, then:
(Total > 512)checksum = 768 - Total

Examples

Add 102 + 90 + 10 = 202. The total is less than 256 so use A. to calculate checksum.

Checksum = 256 - 202
Checksum = 54
PW = 102,90,10,54

Add 238 + 95 + 170 = 503. The total is greater than 256 but less than or equal to 512 so use B. to calculate checksum.

Checksum = 512 - 503
Checksum = 9
PW = 238,95,170,9

Add 255 + 90 + 170 = 515. The total is greater than 512 so use C. to calculate checksum.

Checksum = 768 - 515
Checksum = 253
PW = 255,90,170,253

7.4.6 Boot writes remaining <boot_writes_remaining> parameter (read only)

This parameter will be the fourth parameter shown during a read of the PWM settings (PR PW).

The range is from 8 to 0 and represents the number of times remaining that the PWM settings can be written to the boot of the drive.

7.4.7 Example PWM settings by motor specifications

The following settings are based upon IMS settings per motor specifications and should serve as a baseline to work from with regard to the manufacturer specifications of the motor being utilized. Note that these are example settings ONLY!

Frame Size	Stack Size	Phase Current (A _{RMS})	Phase Resistance (Ω)	Phase Inductance (mH)	MASK <mask>	Duty Cycle <period>	Frequency <sfreq>	Checksum <chksum>
14	Single	0.75	4.30	4	102	90	170	250
	Single	1.5	1.30	2.1	136	90	170	116
17	Double	1.5	2.10	5.0	136	90	170	116
	Triple	1.5	2.00	3.85	136	90	170	116
	Single	2.4	0.95	2.4	136	90	170	116
23	Double	2.4	1.20	4.0	136	90	170	116
	Triple	2.4	1.50	5.4	136	90	170	116
	Single	6.3	0.25	1.6	168	95	170	79
34	Double	6.3	0.35	3.3	220	95	170	27
	Triple	6.3	0.50	6.6	253	95	170	250
MForce Default	—	—	—	—	204	95	170	—

Table 7.9 Example PWM settings

Usage Example

```
PW=102,90,150      `set pwm, DO NOT WRITE TO BOOT!
PW=136,90,170,116 `set pwm settings, write to boot

PR PW              `read PWM
Response = 136,90,170,7 `last integer notes 7 boot
                    `writes remaining
```

This page intentionally left blank

8 Sample programs

This section is made up of several example programs designed to aid the user in discovering the MCode programming language.

8.1 Move on an input

```

`Last modified: 01/26/2006
`Purpose: Demonstrate move on input.

`System configuration
S1=0,0      `set IO1 to gen. purpose input, active LOW,
            `sinking
Ms=256      `set pstep resolution to 256 psteps/step
Vi=200000   `set initial velocity to 200000 steps/sec
Vm=2500000  `set max velocity to 2500000 steps/sec
A=1000000   `set acceleration to 1000000 steps/sec2
D=A         `set deceleration equal to acceleration
Hc=2        `set motor holding current to 2%
Rc=75       `set motor run current to 75%
P=0         `set position counter to 0

`Main program
PG 1        `enter program mode at address 1
LB Ga       `label program Ga
P=0         `initialize position counter
LB G1       `label program G1
CL Kb,I1=1  `call subroutine Kb on input HIGH state
H 10        `hold program execution 10 msec
BR G1       `loop to G1

`Subroutine from trigger event
LB Kb       `declare subroutine Kb
MA 51200    `move to absolute motor position 51200
H           `suspend program execution until motion
            `completes
MA 0        `move to absolute motor position 0
H           `suspend program execution until motion
            `completes
RT         `return from subroutine

E           `designate end of program
PG         `exit to immediate mode

```

8.2 Change velocity during a move

This program will demonstrate ability to change speed during move. The device does not have ability to change speed during point to point move, so we use the slew command with position trips. End position trip, decel and slew speed determine actual ending position. Program is written to print ending position to serial port 100 times for averaging, expected end position = 102400.

```

`System configuration
Ms=256      `set µstep resolution to 256 µsteps/step

Hc=20      `set motor holding current to 20%
Rc=100     `set motor run current to 75%

`Main program
PG 1
LB Ga      `Program Label Ga sets up local variables and
           `register values
           Vi=20000
           Vm=500000
           A=500000
           D=800000000
           R1=0
           R2=0
LB Gx      `Program label Gx sets up position
           `trips and math functions
           P=0
           Tp=51200,Kb      `set position trip at P=51200
           Te=2
           SL 101200
           H
           H 250
           R1=R1+1          `increment R1
           R2=R2+P          `add position to r2 to set up position
calculation
           BR Gx,R1<100     `loop to Gx if R1 indicates less than
                           `100 moves
           R2=R2/100        `after 100 moves have completed, r2 is
                           `divided by 100
           PR "Average end pos = ",R2      `to obtain and print
                           `final Pos.
           E

`Subroutines
LB Kb      `Subroutine called by position trip in
           `Gx which doubles
           `the motor speed
           SL 202400
           Tp=102290,Kc
           Te=2
           RT

LB Kc      `Subroutine executed by position trip
in Kb
           SL 0
           H
           RT

PG

```

8.3 Binary mask

This program will demonstrate ability to execute various subroutines depending on the binary value of inputs 1-3 while masking all i/o above input 3.

```

`System configuration
S1=0,1      `setup IO points 1-4, 9-11 as General purpose
user
S2=0,1
S3=0,1
S4=0,1
S9=0,1
S10=0,1
S11=0,1
S12=16,0   `set up IO point 12 as a gen. purp. output
Ms=256     `global system variable declarations
Vi=20000
Vm=1000000
A=500000
D=A
Hc=20
Rc=75

`Main program
PG 1
LB Ga
P=0
LB G1
R1=In      `capture input combined value to register 1
R1=R1 & 7  `bits 00000111=7
CL k0,R1 = 0  `Subroutine calls based on the decimal
              `value of IO
CL k1,R1 = 1  `points 1-3
CL k2,R1 = 2
CL k3,R1 = 3
CL k4,R1 = 4
CL k5,R1 = 5
CL k6,R1 = 6
CL k7,R1 = 7
H 10
BR G1
E

`Subroutines
LB k0                      `Declare sub K0 executed if R1=0
PR "Logic 000"
MR 0*51200
H
H 200
RT

LB k1                      `Declare sub K1 executed if R1=1
PR "Logic 001"
MR 1*51200
H
H 200
RT

LB k2                      `Declare sub K2 executed if R1=2
PR "logic 010"
MR 2*51200
H
H 200

```

```
RT
LB k3                                `Declare sub K3 executed if R1=3
  PR `Logic 011"
  MR 3*51200
  H
  H 200
  RT
LB k4                                `Declare sub K4 executed if R1=4
  PR `Logic 100"
  MR 4*51200
  H
  H 200
  RT
LB k5                                `Declare sub K5 executed if R1=5
  PR `Logic 101"
  MR 5*51200
  H
  H 200
  RT
LB k6                                `Declare sub K6 executed if R1=6
  PR `Logic 110"
  MR 6*51200
  H
  H 200
  RT
LB k7                                `Declare sub K7 executed if R1=7
  PR `Logic 111"
  MR 7*51200
  H
  H 200
  RT
E
PG
```

8.4 Closed Loop

This program illustrates closed loop control with an On Error (OE) routine which will perform math functions on the counters to display the position error.

```

`System configuration
Ms=256      `declare global system variables and flags
Hc=5
Rc=80
Ee=1        `encoder enabled
A=60000
D=A
Vi=2048
Vm=30000
S1=0,0
Sf=15      `encoder stall variables declared
Sm=0
Mt=50
VA Q1      `user variable Q1 declared

`Main program
PG 1
LB Ga      `Ga declares the error call and locally
           `sets the position
           OE k1  `counter to 0 encoder counts
           P=0
LB Gb      `Gb performs ± motions and increments
           `Q1 after each
           MR 51200 `until Q1 reaches 100
           H
           H 500
           MR -51200
           H
           H 500
           IC Q1
           BR Gb,Q1<100
E

`Subroutines
LB k1      `Sub K1 calculates the position error
           `by dividing
           R3=C1/25      `actual motor steps moved by 25 and
           `subtracts
           R1=R3 - C2    `the number of encoder counts in C2 to
           `determine
           PR "Counts error = ",R1 `the counts error
           PR "Error = ",Er
           Er=0
           H 20
           RT
E
PG

```

8.5 User input into variables

This program demonstrates the ability to hold up program execution while the user enters multiple variables. Uses registers R1-R3 and a user declared flag for program control.

```

`System configuration
Ms=256      `Global variable declarations
Vi=10000
Vm=50000
A=10000
D=A
Hc=5
Rc=70
P=0
R1=0        `Registers set to 0
R2=0
R3=0
VA X1=0     `User flag X1 declared and set to 0

`Main program
PG 1
LB G1       `Local var-flg settings
P=0
X1=0
LB G2       `label for program hold loop
H 20
BR G1,X1=0 `command for pg hold loop
LB G3
X1=0       `reset x1 to 0.
A=R1       `set A to R1 value
D=A
Vm=R2
MR R3
H
H 500
BR G2
PG

```

8.6 Closed loop with homing

This program demonstrates the use of the home to home switch instruction (HM) in closed loop, also there is a move on input routine.

```

Ee=1           `Global variable and flag declarations
Vm=4096
Vi=Vm/50
A=20480
D=A
Hc=50
Rc=50
Mt=50
Sf=20
Sm=0
Db=5
S1=1,0       `Home input
S2=0,0       `Move on input
S3=17,0      `Moving output
S4=19,0      `Fault output

D1=100

`Program
PG 1
LB G1
H 1000
PR "C1 ",C1
PR "C2 ",C2
Pm=1
PR "C1 ",C1
PR "C2 ",C2
H 5000
HM 1
H
P=0
LB G2
BR G2,I2=0
MR 7186
H
PR "p=",P
BR G2
E
PG

```

8.7 Input trip

This program demonstrates the use input trips

```

`System configuration
Ms=256
Hc=0
Rc=100
D=800000000
Vi=10000
Vm=50000
S1=0,0
S2=16,0
S3=16,0
S4=16,0
O2=1
O3=1
O4=1

`Main program
PG 1
LB Ga
  CL K1 `call to configure 1st input trip
  SL 50000
LB Gb
  H 10
  BR Gb,Mv>0
  R3=R2-R1
  PR `Distance between inputs = `,R3
  H 1000
  PR ` `
  BR Ga
  E

`Subroutines
LB K1 `Config for 1st input trip
  S1=0,0
  Ti=1,K2
  Te=1
  RT

LB K2 `Config for 2nd input trip
  R1=Pc
  S1=0,1
  Ti=1,K3
  Te=1
  RT

LB K3 `Sub for 2nd input trip
  R2=Pc
  SL 0

LB K4
  BR K4,Vc=1
  RT

E
PG

```

9 Error codes

A question mark <?> Displayed as a cursor indicates an error. To determine what the error is, type <pr er> in the terminal window. The device will respond with an error number displayed in the terminal window. The error number may then be referenced to this list.

0 No Error

9.1 I/O errors

6	An I/O is already set to this type. Applies to non-General Purpose I/O.
8	Tried to set an I/O to an incorrect I/O type.
9	Tried to write to I/O set as Input or is "TYPED".
10	Illegal I/O number.
11	Incorrect CLOCK type.
12	Illegal Trip / Capture

9.2 Data errors

20	Tried to set unknown variable or flag. Trying to set an undefined variable of flag. Also could be a typo.
21	Tried to set an incorrect value. Many variables have a range such as the Run Current (RC) which is 1 to 100%. As an example, you cannot set the RC to 110%.
22	VI is set greater than or equal to VM. The Initial Velocity is set equal to, or higher than the Maximum Velocity. VI must be less than VM.
23	VM is set less than or equal to VI. The Maximum Velocity is set equal to, or lower than the Initial Velocity. VM must be greater than VI.
24	Illegal data entered. Data has been entered that the device does not understand.
25	Variable or flag is read only. Read only flags and variables cannot be set.
26	Variable or flag is not allowed to be incremented or decremented. IC and DC cannot be used on variables or flags such as Baud and Version.
27	Trip not defined. Trying to enable a trip that has not yet been defined.
28	WARNING! Trying to redefine a program label or variable. This can be caused when you download a program over a program already saved. Before downloading a new or edited program, type <FD> and press ENTER to return the device to the Factory Defaults. You may also type <CP> and press ENTER to Clear the Program.
29	Trying to redefine a built in command, variable or flag.
30	Unknown label or user variable. Trying to Call or Branch to a Label or Variable that has not yet been defined.

31	Program label or user variable table is full. The table has a maximum capacity of 22 labels and/or user variables.
32	Trying to set a label (LB). You cannot name a label and then try to set it to a value. Example: Lable P1 (LB P1). The P1 cannot be used to set a variable such as P1=1000.
33	Trying to SET an Instruction.
34	Trying to Execute a Variable or Flag
35	Trying to Print Illegal Variable or Flag
36	Illegal Motor Count to Encoder Count Ratio
37	Command, Variable or Flag Not Available in Drive
38	Missing parameter separator
39	Trip on Position and Trip on Relative Distance not allowed together

9.3 Program errors

40	Program not running. If HOLD (H) is entered in Immediate Mode and a program is not running.
41	Stack overflow
42	Illegal program address. Tried to Clear, List, Execute, etc. an incorrect Program address.
43	Tried to overflow program stack. Calling a Sub-Routine or Trip Routine with no Return.
44	Program locked. User Programs can be Locked with the <LK> command. Once Locked, the program cannot be listed or edited in any way.
45	Trying to Overflow Program Space.
46	Not in Program Mode.
47	Tried to Write to Illegal Flash Address
48	Program Execution stopped by I/O set as Stop.

9.4 Communications errors

60	Not used
61	Trying to set illegal BAUD rate. The only Baud Rates accepted are those listed on the Properties Page of IMS Terminal. (4,800, 9,600, 19,200, 38,400, 115,200)
62	IV already pending or IF Flag already TRUE.
63	Character over-run. Character was received. Processor did not have time to process it and it was over-written by the next character.
64	Startup Calibration failed (Hybrid only)

9.5 System errors

70	FLASH Check Sum Fault
71	Internal Temperature Warning, 10C to Shutdown
72	Internal Over TEMP Fault, Disabling Drive
73	Tried to SAVE while moving
74	Tried to Initialize Parameters (IP) or Clear Program (CP) while Moving
75	Linear Overtemperature Error (For units without Internal Over Temp)

9.6 Motion errors

80		HOME switch not defined. Attempting to do a HOME (H) sequence but the Home Switch has not yet been defined.
81		HOME type not defined. The HOME (HM or HI) Command has been programmed but with no type or an illegal type. (Types = 1, 2, 3, or 4)
82		Went to both LIMITS and did not find home. The motion encroached both limits but did not trip the Home switch. Indicates a possible bad switch or a bad circuit.
83		Reached plus LIMIT switch. The LIMIT switch in the plus direction was tripped.
84		Reached minus LIMIT switch. The LIMIT switch in the minus direction was tripped.
85		MA or MR isn't allowed during a HOME and a HOME isn't allowed while the device is in motion.
86		Stall detected. The Stall Flag (ST) has been set to 1.
87	MDrive	In Clock Mode, JOG not allowed
	Hybrid	Not allowed to change AS mode while calibrating
88	MDrive	Following error
	Hybrid	Moves not allowed while calibration is in progress.
89	MDrive	Reserved
	Hybrid	Calibration not allowed while motion is in progress.
90		Motion Variables are too low switching to EE=1
91		Motion stopped by I/O set as Stop.
92		Position Error in Closed loop. motor will attempt tp position the shaft within the deadband, After failing 3 attempts Error 92 will be generated. Axis will continue to function normally.
93		MR or MA not allowed while correcting position at end of previous MR or MA.

9.7 Hybrid errors

100	Configuration test done, encoder resolution mismatch
101	Configuration test done, encoder direction incorrect
102	Configuration test done, encoder resolution and direction incorrect
103	Configuration not done, drive not enabled
104	Locked rotor
105	Maximum position count reached
106	Lead limit reached
107	Lag limit reached
108	Reserved
109	Calibration failed

WARRANTY

TWENTY-FOUR (24) MONTH LIMITED WARRANTY

Schneider Electric Motion USA warrants only to the purchaser of the Product from Schneider Electric Motion USA (the "Customer") that the product purchased from Schneider Electric Motion USA (the "Product") will be free from defects in materials and workmanship under the normal use and service for which the Product was designed for a period of 24 months from the date of purchase of the Product by the Customer. Customer's exclusive remedy under this Limited Warranty shall be the repair or replacement, at Company's sole option, of the Product, or any part of the Product, determined by Schneider Electric Motion USA to be defective. In order to exercise its warranty rights, Customer must notify Company in accordance with the instructions described under the heading "Obtaining Warranty Service".

NOTE: MDrive Motion Control electronics are not removable from the motor in the field. The entire unit must be returned to the factory for repair.

This Limited Warranty does not extend to any Product damaged by reason of alteration, accident, abuse, neglect or misuse or improper or inadequate handling; improper or inadequate wiring utilized or installed in connection with the Product; installation, operation or use of the Product not made in strict accordance with the specifications and written instructions provided by IMS; use of the Product for any purpose other than those for which it was designed; ordinary wear and tear; disasters or Acts of God; unauthorized attachments, alterations or modifications to the Product; the misuse or failure of any item or equipment connected to the Product not supplied by Schneider Electric Motion USA; improper maintenance or repair of the Product; or any other reason or event not caused by Schneider Electric Motion USA.

Schneider Electric Motion USA HEREBY DISCLAIMS ALL OTHER WARRANTIES, WHETHER WRITTEN OR ORAL, EXPRESS OR IMPLIED BY LAW OR OTHERWISE, INCLUDING WITHOUT LIMITATION, ANY WARRANTIES OF MERCHANTABILITY OR FITNESS FOR ANY PARTICULAR PURPOSE. CUSTOMER'S SOLE REMEDY FOR ANY DEFECTIVE PRODUCT WILL BE AS STATED ABOVE, AND IN NO EVENT WILL IMS BE LIABLE FOR INCIDENTAL, CONSEQUENTIAL, SPECIAL OR INDIRECT DAMAGES IN CONNECTION WITH THE PRODUCT.

This Limited Warranty shall be void if the Customer fails to comply with all of the terms set forth in this Limited Warranty. This Limited Warranty is the sole warranty offered by Schneider Electric Motion USA with respect to the Product. Schneider Electric Motion USA does not assume any other liability in connection with the sale of the Product. No representative of Schneider Electric Motion USA is authorized to extend this Limited Warranty or to change it in any manner whatsoever. No warranty applies to any party other than the original Customer.

Schneider Electric Motion USA and its directors, officers, employees, subsidiaries and affiliates shall not be liable for any damages arising from any loss of equipment, loss or distortion of data, loss of time, loss or destruction of software or other property, loss of production or profits, overhead costs, claims of third parties, labor or materials, penalties or liquidated damages or punitive damages, whatsoever, whether based upon breach of warranty, breach of contract, negligence, strict liability or any other legal theory, or other losses or expenses incurred by the Customer or any third party.

OBTAINING WARRANTY SERVICE

If the Product was purchased from an Schneider Electric Motion USA Distributor, please contact that Distributor to obtain a Returned Material Authorization (RMA). If the Product was purchased directly from Schneider Electric Motion USA, please contact Customer Service at info@motion.schneider-electric.com or 860-295-6102 (Eastern Time Zone).

Customer shall prepay shipping charges for Products returned to Schneider Electric Motion USA for warranty service and Schneider Electric Motion USA shall pay for return of Products to Customer by ground transportation. However, Customer shall pay all shipping charges, duties and taxes for Products returned to Schneider Electric Motion USA from outside the United States.

Schneider Electric Motion USA

370 North Main Street, P.O. Box 457

Marlborough, CT 06447 - U.S.A.

Tel. +00 (1) 860 295-6102 - Fax +00 (1) 860 295-6107

e-mail: info@imshome.com

<http://motion.schneider-electric.com>

© Schneider Electric Motion USA All Rights Reserved.

*Product Disclaimer and most recent product information at
motion.schneider-electric.com.*

REV062812

