

# MDrive<sup>®</sup> 23 Microstepping



**IMS**  
INTELLIGENT MOTION  
SYSTEMS, INC.

**Schneider**  
Electric

## Specifications

Electrical Specifications	
Input Voltage (+V) Range*	+12 to +75 VDC
Max Power Supply Current (Per MDrive 23)*	2 A

\*Actual Power Supply Current will depend on voltage and load.

Environmental Specifications	
Operating Temperature (non-condensing)	Heat Sink: -40°C to +85°C Motor: -40°C to +100°C

Isolated Input Specifications		
Step Clock, Direction and Enable	Universal	Differential
Voltage Range (Sinking or Sourcing)	+5 to +24 VDC	0 to +5VDC
Input High Level Voltage	—	3.75 to 5.75 VDC
Input Low Level Voltage	—	≤ 1.2 VDC
Current (+5V Max)	8.7 mA	11.7 mA
Current (+24V Max)	14.6 mA	—

Motion Specifications	
Digital Filter Range	50 nS to 12.9 μS (10 MHz to 38.8 kHz)
Clock Types	Step/Direction, Up/Down, Quadrature
Step Frequency (Max)	5 MHz
Step Frequency Minimum Pulse Width	100 nS
Number of Microstep Resolution Settings	20

Available Microsteps Per Revolution									
200	400	800	1000	1600	2000	3200	5000	6400	10000
12800	20000	25000	25600	40000	50000	51200	36000 <sup>1</sup>	21600 <sup>2</sup>	25400 <sup>3</sup>

1=0.01 deg/μstep    2=1 arc minute/μstep    3=0.001 mm/μstep

## Setup Parameters

Setup Parameters				
Name	Function	Range	Units	Default
MHC	Motor Hold Current	0 to 100	Percent	5
MRC	Motor Run Current	1 to 100	Percent	25
MSEL	Microstep Resolution	See Motion Specifications	μsteps/ Full Step	256
DIR	Motor Direction Override	0/1	—	CW
HCDT	Hold Current Delay Time	0 or 2 - 65535	mSec	500
CLK TYPE	Clock Type	See Motion Specifications	—	Step/ Direction
CLK IOF	Clock Input Filter	50 nS to 12.9 μS (10 MHz to 38.8 kHz)	nS (MHz)	200 nS (2.5MHz)
EN ACT	Enable Active High/Low	High/Low	—	High
USER ID	User ID	3 Characters Viewable ASCII	Viewable ASCII	IMS

## Mechanical Specifications

NOTE: For linear actuator products, see manual for screw specifications

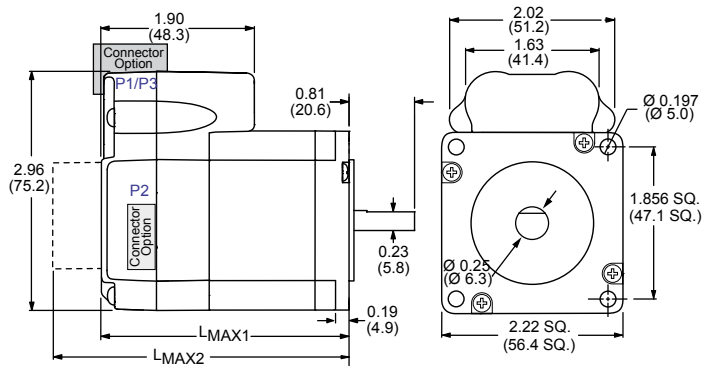

Motor Length	Dimensions in inches (mm)	
	LMAX1 (Single Shaft or Internal Encoder)	LMAX2 (Control Knob or External Encoder)
Single	2.65 (67.31)	3.36 (85.34)
Double	3.02 (76.71)	3.73 (94.74)
Triple	3.88 (98.55)	4.59 (116.59)

## Minimum Required Connections

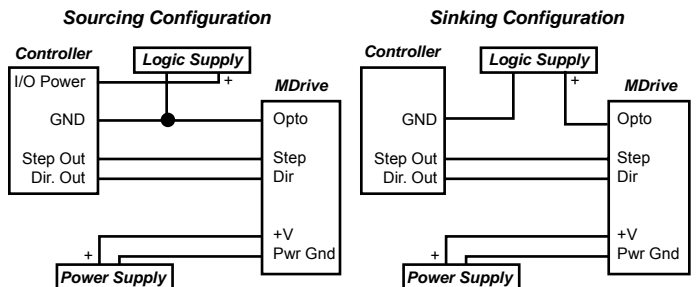

## Notes and Warnings

Installation, configuration and maintenance must be carried out by qualified technicians only. You must have detailed information to be able to carry out this work. This information can be found in the user manual.

- Unexpected dangers may be encountered when working with this product!
- Incorrect use may destroy this product and connected components!

The user manual is not included, but may be obtained from the Internet at: <http://www.imshome.com/downloads/manuals.html>.

## Required for Setup\*

- PC running Microsoft<sup>®</sup> Windows XP Service Pack 2 or greater.
- SPI Motor Interface (available online).
- +12 to +75 VDC unregulated linear or switching power supply.
- 0 to 5 MHz clock signal for step clock, may be a controller high speed output or signal generator.
- SPST switch or controller I/O point to control axis direction.
- SPI communications interface (recommended: MD-CC300-001 or MD-CC303-001 communication converters).

Depending on your MDrive connectors configuration, you may also need:

- If using a 7-pin pluggable terminal we recommend 22 AWG shielded twisted pairs for logic wiring. Wire gauge for power connection varies with the distance from the MDrive and current. See the product manual for requirements.
- I/O, Power and Communications interface to 12-pin wire crimp connector (recommended: PD12-1434-FL3 prototype development cable).

\* If you purchased your MDrive with a QuickStart Kit, you have received all of the connecting cables needed for initial functional setup and system testing.

## Getting Started

All documentation, software and resources are available online at: [http://www.imshome.com/products/mdrive\\_motor\\_driver.html](http://www.imshome.com/products/mdrive_motor_driver.html).

## Connecting Power and I/O

Your MDrive is configured with power and I/O combined on a single connector. Please refer to the opposite side of this document for connecting details and available connectivity options including prototype development cables and mating connector kits.

## Connecting Communications

1. Connect IMS USB to SPI communications converter to MDrive and PC.
2. Install the communication converter drivers onto PC (available online).
3. Install and open SPI Motor Interface.
4. Apply power to MDrive.
5. Parameters may be adjusted via two screens, the Motor Settings screen or the I/O Settings screen (shown below), accessible via the View menu.

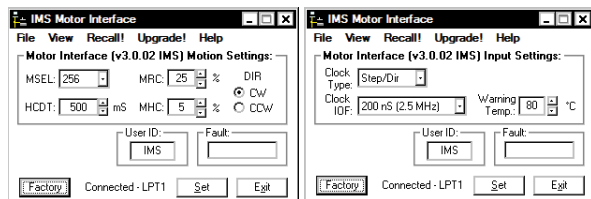

Motor Settings Screen

I/O Settings Screen

# MDrive 23 Microstepping Connectivity Options

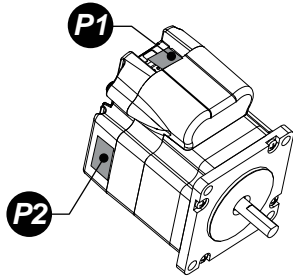

Connector Style	Function
<b>P1</b> Pluggable Terminal.....	I/O and Power
Flying Leads.....	I/O and Power
12-pin Wire Crimp.....	I/O, Power and Communications
<b>P2</b> 10-pin IDC.....	Communications

## **P1** I/O & Power (Universal or Differential Inputs)

Pluggable terminal or flying leads

### Pluggable Terminal

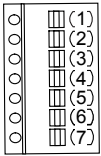

Pin #	Universal	Differential
1	Opto	CW+
2	No Connect	No Connect
3	Step Clock	CW-
4	Direction	CCW-
5	Enable	CCW+
6	Ground	Ground
7	+V	+V

User Supplied Recommended  
Wire: 22 AWG Stranded

### Flying Lead Colors

Wire Color	Universal	Differential
White	Opto	CW+
Orange	Step Clock	CW-
Blue	Direction	CCW-
Brown	Enable	CCW+
Black	Ground	Ground
Red	+V	+V

## **P2** Communications

10-pin IDC

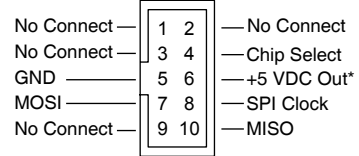

\*Used to power the MD-CC300-001 only.

### Communications Converter p/n: MD-CC300-001

Electrically isolated in-line USB to SPI converter pre-wired with mating connector to conveniently program and set configuration parameters.

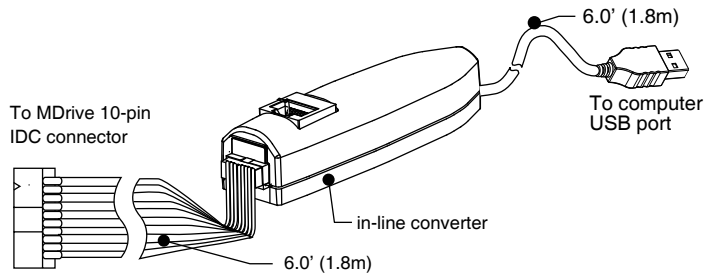

### Mating Connector Kit p/n: CK-01

Use to make your own cables, kit contains 5 mating connector shells for making interface cables.

IDC Parts Shell: SAMTEC TCSD-05-01-N  
Ribbon Cable: AMP 1-57051-9

## Encoder Options

Three (3) different encoder styles are available, detailed below. Please see the product manual for pin numbering and location.

### Optional Encoder Cables

#### Internal

Differential Magnetic

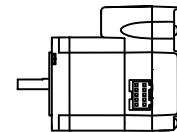

p/n: ED-CABLE-JST10  
10.0' (3.0 m)

#### wire color: function

Orange/White: CH B-  
White/Orange: CH B+  
White/Blue: IDX+  
Blue/White: IDX-  
White/Green: CH A+  
Green/White: CH A-  
White/Brown: Ground  
Brown/White: N/C

#### External

Differential Optical

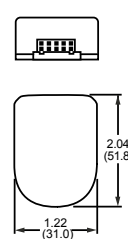

p/n: ED-CABLE-6  
6.0' (1.8 m)

#### wire color: function

Orange/White: +5 VDC In  
White/Orange: Ground  
White/Blue: CH A-  
Blue/White: CH A+  
White/Green: CH B-  
Green/White: CH B+  
White/Brown: Ground  
Brown/White: IDX+

#### External

Single-End Optical

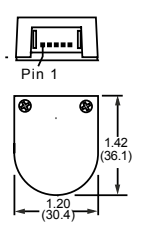

p/n: ES-CABLE-2  
12" (30.4 cm)

#### wire color: function

(Pin 1) Brown: Ground  
Violet: IDX  
Blue: CH A  
Orange: +5 VDC In  
Yellow: CH B

### Communications Converter p/n: MD-CC303-001

Electrically isolated in-line USB to SPI converter pre-wired with mating connector to conveniently program and set configuration parameters. A secondary cable from the mating connector provides interface to power and I/O.

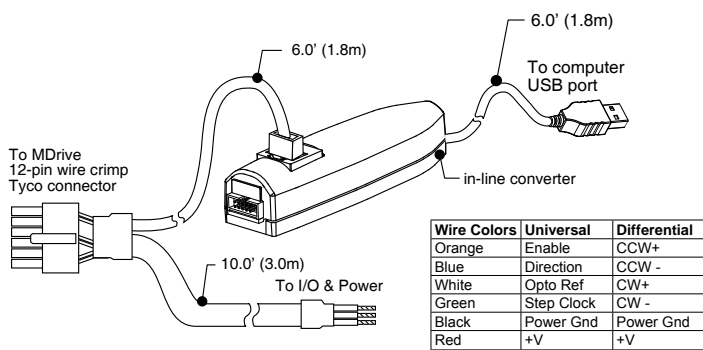

Wire Colors	Universal	Differential
Orange	Enable	CCW+
Blue	Direction	CCW -
White	Opto Ref	CW+
Green	Step Clock	CW -
Black	Power Gnd	Power Gnd
Red	+V	+V

### Prototype Development Cable p/n: PD12-1434-FL3

Speed test and development with pre-wired mating connector.

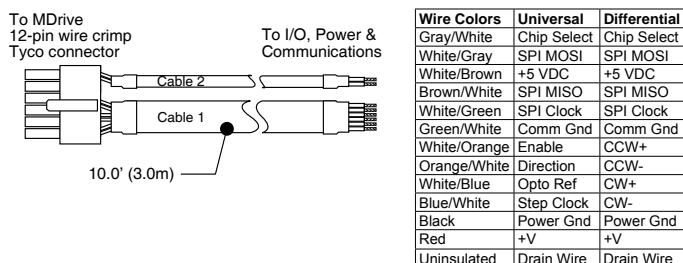

Wire Colors	Universal	Differential
Gray/White	Chip Select	Chip Select
White/Gray	SPI MOSI	SPI MOSI
White/Brown	+5 VDC	+5 VDC
Brown/White	SPI MISO	SPI MISO
White/Green	SPI Clock	SPI Clock
Green/White	Comm Gnd	Comm Gnd
White/Orange	Enable	CCW+
Orange/White	Direction	CCW-
White/Blue	Opto Ref	CW+
Blue/White	Step Clock	CW-
Black	Power Gnd	Power Gnd
Red	+V	+V
Uninsulated	Drain Wire	Drain Wire

### Mating Connector Kit p/n: CK-03

Use to make your own cables, kit contains 5 mating connector shells for making interface cables. Tyco crimp tool recommended.

Tyco Parts Shell: 1-794617-2  
Pins: 794610-1

## Differential Input Option

Replaces the 0 to 24VDC Universal inputs with +5 VDC tolerant line driven differential inputs.

The inputs replaced are shown in the table on the right with the differential input counterpart.

**NOTE! The differential inputs have a maximum input voltage of 5.75 VDC!**

**DO NOT EXCEED THIS LEVEL!**

Universal Input	Differential Input
Opto Reference	CW +
Step Clock Input	CW -
CW/CCW Direction Input	CCW -
Enable Input	CCW +

