

# Quick Reference MForce MicroDrive Motion Control



**IMS**  
INTELLIGENT MOTION  
SYSTEMS, INC.

**Schneider**  
Electric

## Notes and Warnings

Installation, configuration and maintenance must be carried out by qualified technicians only. You must have detailed information to be able to carry out this work. This information can be found in the user manuals.

- Unexpected dangers may be encountered when working with this product!
- Incorrect use may destroy this product and connected components!

The user manuals are not included, but may be obtained from the Internet at: <http://www.imshome.com/downloads/manuals.html>.

## Required for Setup\*

- PC running Microsoft® Windows XP Service Pack 2 or greater.
- IMS Terminal integrated program editor and terminal emulator (available online).
- +12 to +48 VDC unregulated linear or switching power supply.
- NEMA size 14, 17 or 23 stepping motor.
- RS-422/485 communications interface (recommended: MD-CC400-001 or MD-CC402-001 communication converters). Or CANopen communications converter (recommended: MD-CC500-000).

Depending on your connector configuration, you may also need:

- If using a 7-pin pluggable terminal we recommend 22 AWG shielded twisted pairs for logic wiring. Wire gauge for power connection varies with the distance from the MForce and current. See product manual.
- I/O and Power interface to 16-pin wire crimp connector (recommended: PD16-1417-FL3 prototype development cable).
- Motor interface to 4-pin wire crimp connector (recommended: PD04-MF17-FL3 prototype development cable).

\* If you purchased your MForce MicroDrive with a QuickStart Kit, you have received all of the connecting cables needed for initial functional setup and system testing.

## Getting Started

All documentation, software and resources are available online at: [http://www.imshome.com/products/mforce\\_overview.html](http://www.imshome.com/products/mforce_overview.html).

### Connecting the Motor, Power and I/O

Your MForce MicroDrive is configured with power and I/O combined on a single connector, with the motor on a separate connector. Please refer to the opposite side of this document for connecting details and available connectivity options including prototype development cables and mating connector kits.

### Connecting Communications — RS-422/485

1. Connect RS-422/485 communications converter to MForce MicroDrive and PC.
2. Install the communication converter drivers onto PC (available online).
3. Install and open IMS Terminal.
4. Apply power to MForce MicroDrive.
5. Within IMS Terminal, Click into the terminal window (shown below).
6. Key in CTRL+C. The sign-on message: "Copyright 2001-2008 by Intelligent Motion Systems, Inc." should appear, verifying that communications is active.

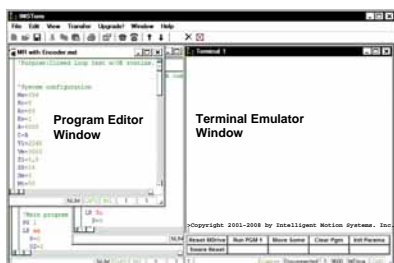

### Connecting Communications — CANopen

A "Getting Started" tutorial using the CANopen Tester GUI with the MD-CC500-000 USB to CANopen dongle is located in the CANopen implementation manual, available online.

All documentation, software, program examples and resources are available online at: [http://www.imshome.com/products/mforce\\_overview.html](http://www.imshome.com/products/mforce_overview.html).

## General Specifications

Electrical Specifications	
Input Voltage (+V) Range*	+12 to +48 VDC
Max Power Supply Current (Per MForce MicroDrive)*	3 A
Output Current (RMS)	3.0 Amps
Output Current (Peak)	4.2 Amps
Aux-Logic Input Voltage**	+12 to +24 VDC
Aux-Logic Input Current**	161 mA Max

\*Actual Power Supply Current will depend on voltage and load.  
\*\*Used to power logic circuitry in the absence of +V.

Environmental Specifications	
Operating Temperature — measured at the heat sink (non-condensing)	-40°C to +85°C

I/O Specifications	
General Purpose I/O - Number and Type	
I/O Points 1-4	4 I/O programmable as inputs (sinking or sourcing) or outputs (sinking)
I/O Points 1-4, 9-12 (Plus <sup>2</sup> expanded feature)	8 I/O programmable as inputs or outputs (sinking or sourcing)
General Purpose I/O - Electrical	
Inputs	TTL up to +24 VDC
Sinking Outputs	Up to +24 VDC
Sourcing Outputs (Plus <sup>2</sup> expanded feature)	+12 to +24 VDC
Output Sink Current	up to 600 mA (One Channel)
Output Sink Current (Plus <sup>2</sup> expanded feature)	up to 600 mA (One Channel in each I/O Bank)
Logic Threshold (Logic 0)	< 0.8 VDC
Logic Threshold (Logic 1)	> 2.2 VDC
Protection (Sinking)	Over Temp, Short Circuit
Protection (Sourcing)	Transient Over Voltage, Inductive Clamp
Analog Input	
Resolution	10 Bit
Range (Voltage Mode)	0 to +5 VDC, 0 to +10 VDC
Range (Current Mode)	4 to 20 mA, 0 to 20mA
Clock I/O (Plus <sup>2</sup> expanded feature)	
Types	Step/Direction, Up/Down, Quadrature
Logic Threshold	+5V TTL Input, TTL Output (with 2 kΩ Load to Ground)
Trip Output/Capture Input (Plus <sup>2</sup> expanded feature)	
Logic Threshold	+5V TTL Input, TTL Output (with 2 kΩ Load to Ground)

Communications Specifications	
Protocol	RS-422/RS-485
BAUD Rate	4.8k, 9.6k, 19.2k, 38.4k, 115.2 kbps
CANopen Option	
Protocol	CAN 2.0B Active
Communications Profile	CiA DS-301
BAUD Rate	10, 20, 50, 125, 250, 500, 800 kBit/s, 1MBit/s (default)
Note: 800 kbps not supported by the MD-CC500-000 USB to CANopen dongle.	

Motion Specifications									
Microstep Resolution - Open Loop									
Number of Resolutions	20								
Available Microsteps Per Revolution									
200	400	800	1000	1600	2000	3200	5000	6400	10000
12800	20000	25000	25600	40000	50000	51200	36000 <sup>1</sup>	21600 <sup>2</sup>	25400 <sup>3</sup>
1=0.01 deg/μstep    2=1 arc minute/μstep    3=0.001 mm/μstep									

Software Specifications	
Program Storage Type/Size	Flash/6384 Bytes
User Program Labels and Variables	192
Party Mode Addresses	62

## Mechanical Specifications

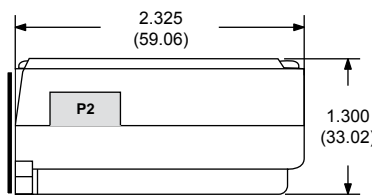
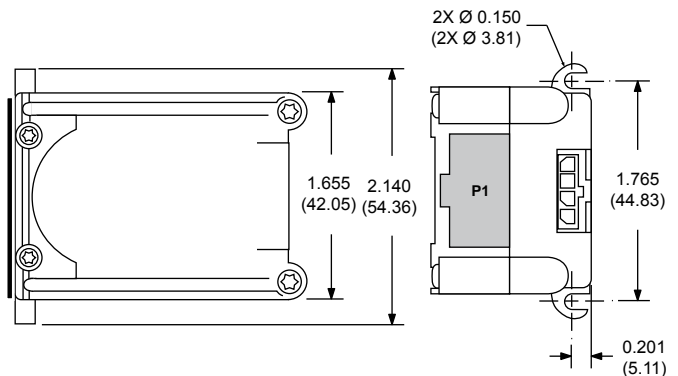

**CAUTION! DO NOT REMOVE THERMAL INSULATING PAD!**  
Mounting without this pad can cause damage to the device

# MForce MicroDrive Motion Control Connectivity Options

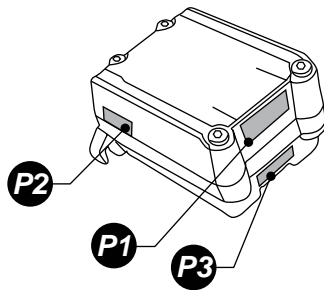

Connector Style	Function
<b>P1</b> Pluggable Terminal.....	I/O and Power
Flying Leads.....	I/O and Power
16-pin Wire Crimp.....	I/O and Power
<b>P2</b> 10-pin Wire Crimp.....	Communications
10-pin IDC.....	Communications
DB-9F .....	Communications (CANopen version)
<b>P3</b> 4-Pin Wire Crimp.....	Motor

## **P1** I/O & Power

Pluggable terminal or flying leads

Pluggable Terminal

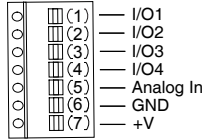

User Supplied Recommended Wire: 22 AWG Stranded

Flying Lead Colors

Wire Color	Function
White/Yellow	I/O1
White/Orange	I/O2
White/Violet	I/O3
White/Blue	I/O4
Green	Analog In
Black	Ground
Red	+V

## **P1** I/O & Power

16-pin wire crimp

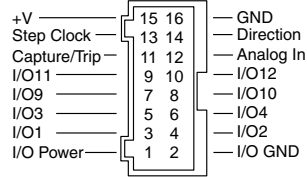

Pin	Function
7	CH A +
8	CH A -
9	CH B +
10	CH B -
13	IDX +
14	IDX -

### Prototype Development Cable p/n: PD16-1417-FL3

Function: Power & I/O Interface

To MForce MicroDrive 16-pin wire crimp JST connector

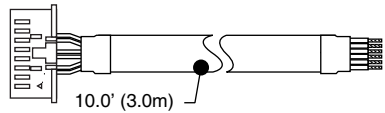

Pair	Wire Colors	Function	Encoder Function
1	White	Step Clock	IDX-
	Black	Direction	IDX+
2	Green	Capt/Trip	Capt/Trip
	Black	Analog In	Analog In
3	Blue	I/O11	CH B+
	Black	I/O12	CH B-
4	Yellow	I/O9	CH A +
	Black	I/O10	CH A -
5	Brown	I/O3	I/O3
	Black	I/O4	I/O4
6	Orange	I/O1	I/O1
	Black	I/O2	I/O2
7	Red	I/O Power	I/O Power
	White	I/O Ground	I/O Ground
8	Red	+V	+V
	Black	Power GND	Power GND

### Mating Connector Kit p/n: CK-10

Use to make your own cables, kit contains 5 mating connector shells with crimp pins. JST crimp tool recommended.

JST Parts Shell: PADP-16V-1-S Pins: SPH-001T-P0.5L

## **P2** Communications — RS-422/485

10-pin wire crimp

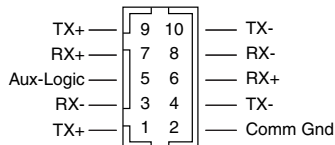

### Communications Converter p/n: MD-CC402-001

Electrically isolated in-line USB to RS-422/485 converter pre-wired with mating connector to conveniently program and set configuration parameters.

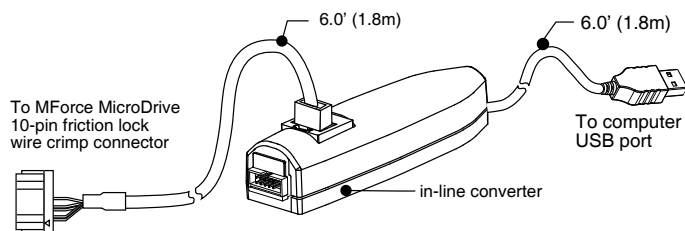

### Prototype Development Cable p/n: PD10-1434-FL3

Speed test and development with pre-wired mating connector. Recommended for multi-drop systems, can be used in conjunction with the MD-CC402-001.

To MForce MicroDrive 10-pin friction lock wire crimp connector

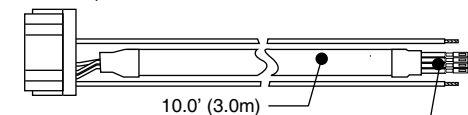

Wire Colors	Function
White/Red Stripe	Aux-Logic
White/Blue Stripe	TX+
Blue/White Stripe	TX-
White/Orange Stripe	RX+
Orange/White Stripe	RX-
Green/White Stripe	GND

Flying leads terminated by crimp pins for multidrop connection (see product manual)

### Mating Connector Kit p/n: CK-02

Use to make your own cables, kit contains 5 mating connector shells with crimp pins. Hirose crimp tool recommended.

Hirose Parts Shell: DF11-10DS-2C Pins: DF11-2428SC

## **P2** Communications — RS-422/485

10-pin IDC

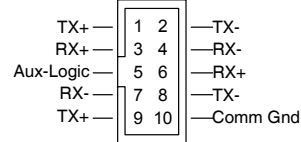

### Communications Converter p/n: MD-CC400-001

Electrically isolated in-line USB to RS-422/485 converter pre-wired with mating connector to conveniently program and set configuration parameters.

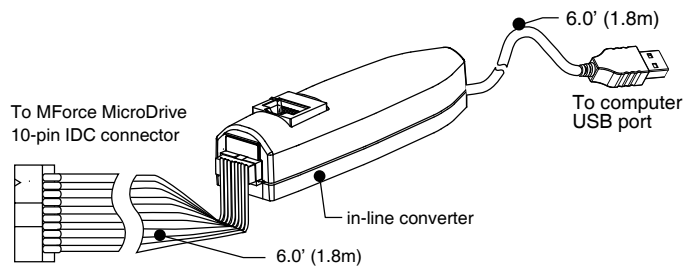

### Mating Connector Kit p/n: CK-01

Use to make your own cables, kit contains 5 mating connector shells for making interface cables.

IDC Parts Shell: SAMTEC TCSD-05-01-N Ribbon Cable: AMP 1-57051-9

## **P2** Communications — CANopen Version

DB-9 (Female)

### Communications Converter p/n: MD-CC500-000

Electrically isolated in-line USB to CANopen converter. USB "A" type connector to DB-9 (male). An interface cable must be constructed by the user to interface to the MForce MicroDrive.

### Mating Cable Requirements

The following diagram illustrates the parts and connections for an interface cable connecting the MD-CC500-000 to the MForce MicroDrive. Parts required connectors: (2) DB-9 (female), +7 to +30 VDC power supply, 120 Ω 1% terminating resistor.

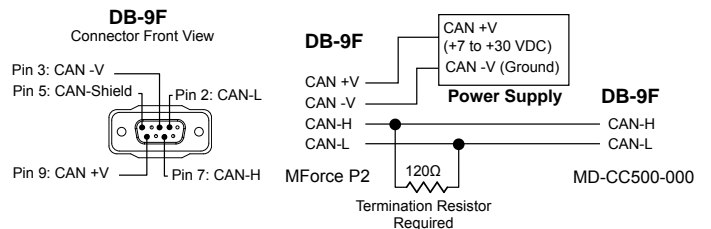

## **P3** Motor

4-pin wire crimp

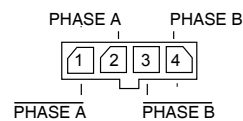

### Prototype Development Cable p/n: PD04-MF17-FL3

Function: Motor Interface

To MForce MicroDrive 4-pin wire crimp Tyco connector

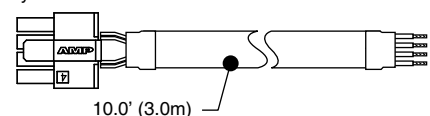

Wire Colors	Function
Green	Phase A
White	Phase A
Red	Phase B
Black	Phase B

### Mating Connector Kit p/n: CK-06

Use to make your own cables, kit contains 5 mating connector shells with crimp pins. Tyco crimp tool recommended.

Tyco Parts Shell: 1445022-4 Pins: 1-794610-1L

**ENSURE PROPER CONNECTION OF THE MOTOR PHASES!**