

# MDrive® 23 Motion Control



### Notes and Warnings

Installation, configuration and maintenance must be carried out by qualified technicians only. You must have detailed information to be able to carry out this work. This information can be found in the user manuals.

- Unexpected dangers may be encountered when working with this product!
- Incorrect use may destroy this product and connected components!

The user manuals are not included. You can obtain them from the Internet at: <http://www.imshome.com/downloads/manuals.html>.

### Required for Setup\*

- PC running Microsoft® Windows XP Service Pack 2 or greater.
- IMS Terminal integrated program editor and terminal emulator (available online).
- +12 to +75 VDC unregulated linear or switching power supply.
- RS-422/485 communications interface (recommended: MD-CC400-001 or MD-CC402-001 Communication Converters). Or CANopen communications converter (recommended: MD-CC500-000).

Depending on your MDrive connectors configuration, you may also need:

- Power interface to 2-pin wire crimp connector (recommended: PD02-2300-FL3 prototype development cable).
- If using the 7-pin pluggable terminal we recommend 22 AWG shielded twisted pairs for logic wiring. Wire gauge for power connection varies with the distance from the MDrive and current. See MDrive product manual.
- I/O interface to 14-pin wire crimp connector. (Recommended: PD14-2334-FL3 prototype development cable)

\* If you purchased your MDrive with a QuickStart Kit, you have received all of the connecting cables needed for initial functional setup and system testing.

### Getting Started

All documentation, software and resources are available online at: [http://www.imshome.com/products/mdrive\\_motor\\_driver.html](http://www.imshome.com/products/mdrive_motor_driver.html).

#### Connecting Power and I/O

Your MDrive is configured with power and I/O combined on a single connector. Please refer to the opposite side of this document for connecting details and available connectivity options including Prototype Development Cables and Mating Connector Kits.

#### Connecting Communications — RS-422/485

1. Connect RS-422/485 communications converter to MDrive and PC.
2. Install the communication converter drivers onto PC (available online).
3. Install and open IMS Terminal.
4. Apply power to MDrive.
5. Within IMS Terminal, click into the Terminal Window (shown below).
6. Key in CTRL+C. The MDrive sign-on message: "Copyright 2001-2008 by Intelligent Motion Systems, Inc." should appear, verifying that communications is active.

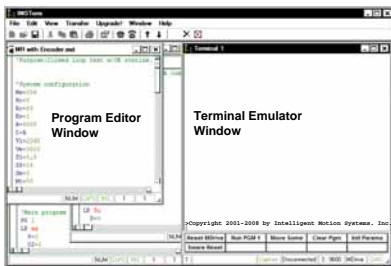

#### Connecting Communications — CANopen

A "Getting Started" tutorial using the IMS CANopen Tester GUI with the MD-CC500-000 USB to CANopen dongle is located in the CANopen implementation manual, available online.

### General Specifications

Electrical Specifications	
Input Voltage (+V) Range*	+12 to +75 VDC
Max Power Supply Current (Per MDrive 23)*	2 A
Aux-Logic Input Voltage**	+12 to +24 VDC
Aux-Logic Input Current**	161 mA Max

\*Actual Power Supply Current will depend on voltage and load.

\*\*Used to power logic circuitry in the absence of +V.

Environmental Specifications		
Operating Temperature (non-condensing)	Heat Sink	-40°C to +85°C
	Motor	-40°C to +100°C

I/O Specifications	
General Purpose I/O - Number and Type	
I/O Points 1-4	4 I/O programmable as inputs (sinking or sourcing) or outputs (sinking)
I/O Points 1-4, 9-12 (Plus <sup>2</sup> expanded feature)	8 I/O programmable as inputs or outputs (sinking or sourcing)

General Purpose I/O - Electrical	
Inputs	TTL up to +24 VDC
Sinking Outputs	Up to +24 VDC
Sourcing Outputs (Plus <sup>2</sup> expanded feature)	+12 to +24 VDC
Output Sink Current	up to 600 mA (one channel)
Output Sink Current (Plus <sup>2</sup> expanded feature)	up to 600 mA (one channel in each I/O bank)
Logic Threshold (Logic 0)	< 0.8 VDC
Logic Threshold (Logic 1)	> 2.2 VDC
Protection (Sinking)	Over Temp, Short Circuit
Protection (Sourcing)	Transient Over Voltage, Inductive Clamp

Analog Input	
Resolution	10 Bit
Range (Voltage Mode)	0 to +5 VDC, 0 to +10 VDC
Range (Current Mode)	4 to 20 mA, 0 to 20mA

Clock I/O	
Types	Step/Direction, Up/Down, Quadrature
Logic Threshold	+5V TTL Input, TTL Output (with 2 kΩ load to ground)

Trip Output/Capture Input	
Logic Threshold	+5V TTL Input, TTL Output (with 2 kΩ load to ground)

Communications Specifications	
Protocol	RS-422/RS-485
BAUD Rate	4.8k, 9.6k, 19.2k, 38.4k, 115.2 kbps
CANopen Option	
Protocol	CAN 2.0B Active
Communications Profile	CIA DS-301
BAUD Rate	10, 20, 50, 125, 250, 500, 800 kBit/s, 1MBit/s (default)
Note: 800 kbps not supported by the MD-CC500-000 USB to CANopen dongle.	

Motion Specifications	
Microstep Resolution - Open Loop	
Number of Resolutions	20

Available Microsteps Per Revolution									
200	400	800	1000	1600	2000	3200	5000	6400	10000
12800	20000	25600	25600	40000	50000	51200	36000 <sup>1</sup>	21600 <sup>2</sup>	25400 <sup>3</sup>
1=0.01 deg/μstep    2=1 arc minute/μstep    3=0.001 mm/μstep									

Software Specifications	
Program Storage Type/Size	Flash/6384 Bytes
User Program Labels and Variables	192
Party Mode Addresses	62

### Mechanical Specifications

NOTE: For linear actuator products, see manual for screw specifications

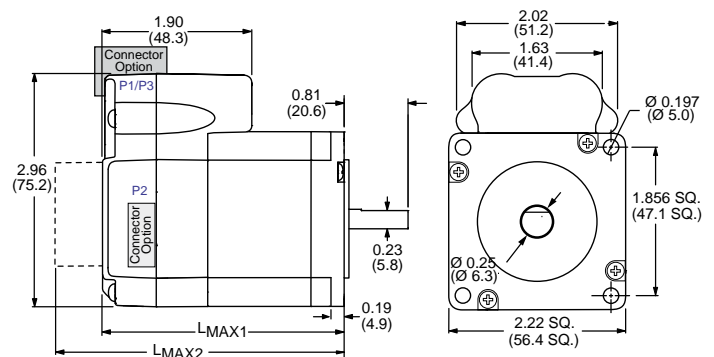

Motor Length	Dimensions in inches (mm)	
	LMAX (Single Shaft or Internal Encoder)	LMAX2 (Control Knob)
Single	2.65 (67.31)	3.36 (85.34)
Double	3.02 (76.71)	3.73 (94.74)
Triple	3.88 (98.55)	4.59 (116.59)

# MDrive 23 Motion Control Connectivity Options

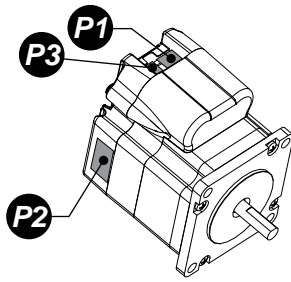

Connector Style	Function
<b>P1</b> Pluggable Terminal.....	I/O and Power
Flying Leads.....	I/O and Power
14-pin Wire Crimp.....	I/O
<b>P2</b> 10-pin Wire Crimp.....	Communications
10-pin IDC.....	Communications
DB-9 (male).....	Communications (CANopen version)
<b>P3</b> 2-pin Wire Crimp.....	Power

## **P1** I/O & Power

Pluggable terminal or flying leads

Pluggable Terminal

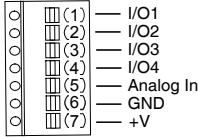

User Supplied Recommended  
Wire: 22 AWG Stranded

Flying Lead Colors

Wire Color	Function
White/Yellow	I/O1
White/Orange	I/O2
White/Violet	I/O3
White/Blue	I/O4
Green	Analog In
Black	Ground
Red	+V

## **P1** I/O

14-pin wire crimp

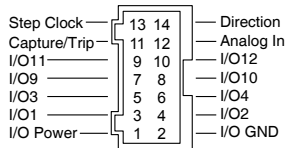

Pin	Function
7	CH A +
8	CH A -
9	CH B +
10	CH B -
13	IDX +
14	IDX -

### Prototype Development Cable p/n: PD14-2334-FL3

Speed test and development with pre-wired mating connector.

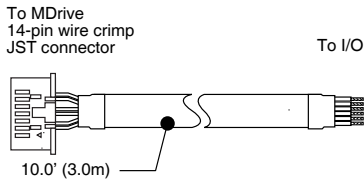

Pair	Wire Colors	Function	Encoder Function
1	White	Step Clock	IDX-
	Black	Direction	IDX+
2	Green	Capt/Trip	Capt/Trip
	Black	Analog In	Analog In
3	Blue	I/O11	CH B +
	Black	I/O12	CH B -
4	Yellow	I/O9	CH A +
	Black	I/O10	CH A -
5	Brown	I/O3	I/O3
	Black	I/O4	I/O4
6	Orange	I/O1	I/O1
	Black	I/O2	I/O2
7	Red	I/O Power	I/O Power
	Black	I/O Ground	I/O Ground

### Mating Connector Kit p/n: CK-09

Use to make your own cables, kit contains 5 mating connector shells with crimp pins. JST crimp tool recommended.

JST Parts Shell: PADP-14V-1-S  
Pins: SPH-001T-P0.5L

## **P3** Power

2-pin wire crimp

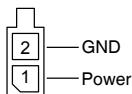

### Prototype Development Cable p/n: PD02-2300-FL3

Function: Power Interface

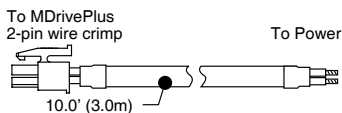

Wire Colors	Function
Black	Power Ground
Red	+V

### Mating Connector Kit p/n: CK-04

Use to make your own cables, kit contains 5 mating connector shells with crimp pins. Tyco crimp tool recommended.

Tyco Parts Shell: 794617-2  
Pins: 794610-1

## **P2** Communications — CANopen version

DB-9 (male)

### Communications Converter p/n: MD-CC500-000

Electrically isolated in-line USB to CANopen converter. USB "A" Type connector to DB-9 (Male). An interface cable must be constructed by the user.

#### Mating Cable Requirements

The following diagram illustrates the parts and connections for an interface cable connecting the MD-CC500-000 to the MDrive. Required Parts: (2) DB-9 (female), +7 to +30 VDC power supply, (1) 120Ω terminating resistor.

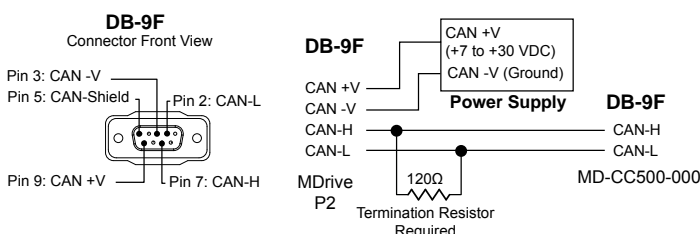

## **P2** Communications — RS-422/485

10-pin wire crimp

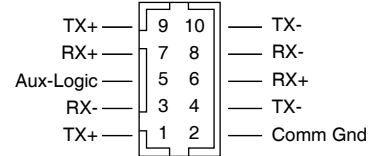

### Communications Converter p/n: MD-CC402-001

Electrically isolated in-line USB to RS-422/485 converter pre-wired with mating connector to conveniently program and set configuration parameters.

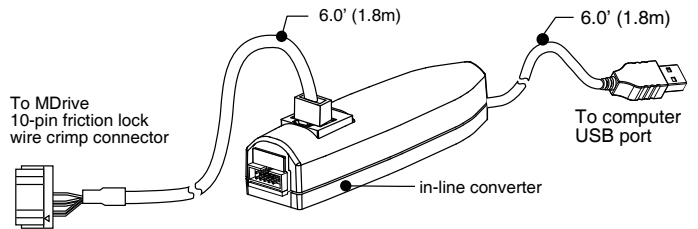

### Prototype Development Cable p/n: PD10-1434-FL3

Speed test and development with pre-wired mating connector. Recommended for multi-drop systems, can be used in conjunction with the MD-CC402-001.

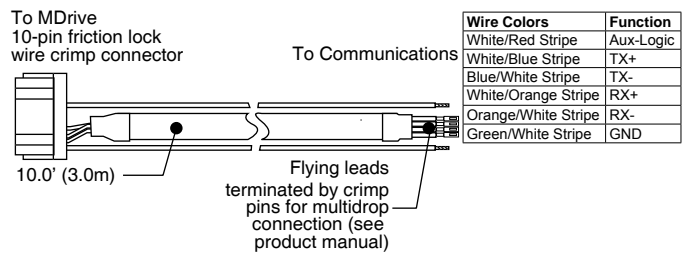

Wire Colors	Function
White/Red Stripe	Aux-Logic
White/Blue Stripe	TX+
Blue/White Stripe	TX-
White/Orange Stripe	RX+
Orange/White Stripe	RX-
Green/White Stripe	GND

### Mating Connector Kit p/n: CK-02

Use to make your own cables, kit contains 5 mating connector shells with crimp pins. Hirose crimp tool recommended.

Hirose Parts Shell: DF11-10DS-2C  
Pins: DF11-2428SC

## **P2** Communications — RS-422/485

10-pin IDC

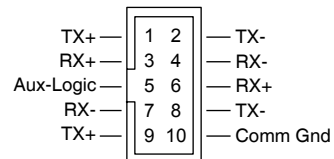

### Communications Converter p/n: MD-CC400-001

Electrically isolated in-line USB to RS-422/485 converter pre-wired with mating connector to conveniently program and set configuration parameters.

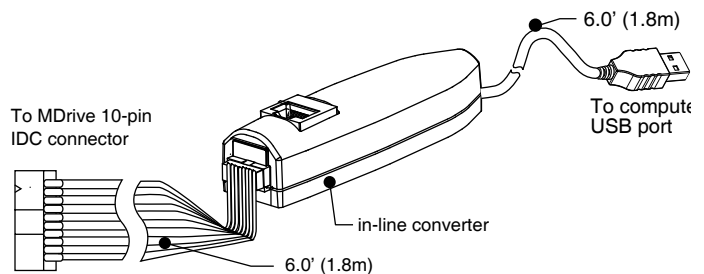

### Mating Connector Kit p/n: CK-01

Use to make your own cables, kit contains 5 mating connector shells for making interface cables.

IDC Parts Shell: SAMTEC TCSD-05-01-N  
Ribbon Cable: AMP 1-57051-9