

MDrive® 34 Motion Control with Flying Leads



General Specifications

Electrical Specifications	
Input Voltage (+V) Range*	+12 to +75 VDC
Max Power Supply Current (Per MDrive 34)*	4 A
Aux-Logic Input Voltage**	+12 to +24 VDC
Aux-Logic Input Current**	194 mA Max

*Actual Power Supply Current will depend on voltage and load.
**Used to power logic circuitry in the absence of +V.

Environmental Specifications		
Operating Temperature (non-condensing)	Heat Sink	-40°C to +75°C
	Motor	-40°C to +90°C

I/O Specifications	
General Purpose I/O - Number and Type	
I/O Points 1-4	4 I/O programmable as inputs (sinking or sourcing) or outputs (sinking)
General Purpose I/O - Electrical	
Inputs	TTL up to +24 VDC
Sinking Outputs	Up to +24 VDC
Output Sink Current	up to 600 mA (one channel)
Logic Threshold (Logic 0)	< 0.8 VDC
Logic Threshold (Logic 1)	> 2.2 VDC
Protection (Sinking)	Over Temp, Short Circuit
Protection (Sourcing)	Transient Over Voltage, Inductive Clamp
Analog Input	
Resolution	10 Bit
Range (Voltage Mode)	0 to +5 VDC, 0 to +10 VDC
Range (Current Mode)	4 to 20 mA, 0 to 20mA

Communications Specifications	
Protocol	RS-422/RS-485
BAUD Rate	4.8k, 9.6k, 19.2k, 38.4k, 115.2 kbps

Motion Specifications	
Microstep Resolution - Open Loop	
Number of Resolutions	20

Available Microsteps Per Revolution									
200	400	800	1000	1600	2000	3200	5000	6400	10000
12800	20000	25000	25600	40000	50000	51200	36000 ¹	21600 ²	25400 ³

1=0.01 deg/μstep 2=1 arc minute/μstep 3=0.001 mm/μstep

Software Specifications	
Program Storage Type/Size	Flash/6384 Bytes
User Program Labels and Variables	192
Party Mode Addresses	62

Mechanical Specifications

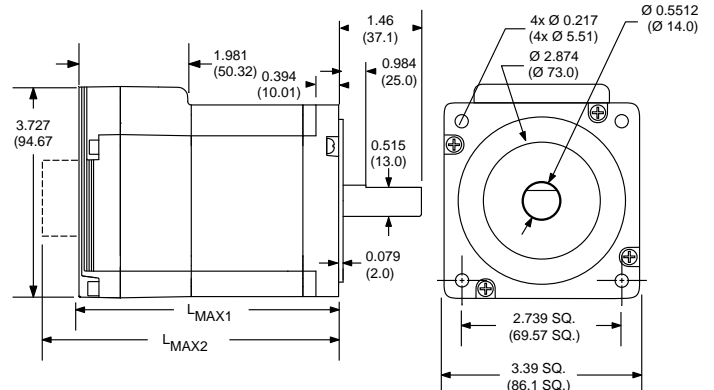

Motor Length	Dimensions in inches (mm)	
	LMAX1 (Single Shaft)	LMAX2 (Control Knob)
Single	3.81 (96.77)	4.52 (114.81)
Double	4.60 (116.84)	5.31 (134.87)
Triple	6.17 (156.72)	6.88 (174.75)

Notes and Warnings

Installation, configuration and maintenance must be carried out by qualified technicians only. You must have detailed information to be able to carry out this work. This information can be found in the user manuals.

- Unexpected dangers may be encountered when working with this product!
- Incorrect use may destroy this product and connected components!

The user manuals are not included. You can obtain them from the Internet at: <http://www.imshome.com/downloads/manuals.html>.

Required for Setup*

- PC running Microsoft® Windows XP Service Pack 2 or greater.
- IMS Terminal integrated program editor and terminal emulator (available online).
- +12 to +75 VDC unregulated linear or switching power supply.
- RS-422/485 communications interface (recommended: MD-CC400-001 or MD-CC402-001 Communication Converters). Or CANopen communications converter (recommended: MD-CC500-000).

Depending on your MDrive connectors configuration, you may also need:

- A break-out board and cabling to interface to the 12" flying leads.

* If you purchased your MDrive with a QuickStart Kit, you have received all of the connecting cables needed for initial functional setup and system testing.

Getting Started

All documentation, software and resources are available online at: http://www.imshome.com/products/mdrive_motor_driver.html.

Connecting Power and I/O

Your MDrive is configured with Power and I/O on 12" flying leads. Please refer to the opposite side of this document for connecting details and available connectivity options.

Connecting Communications — RS-422/485

1. Connect RS-422/485 communications converter to MDrive and PC.
2. Install the communication converter drivers onto PC (available online).
3. Install and open IMS Terminal.
4. Apply power to MDrive.
5. Within IMS Terminal, click into the Terminal Window (shown below).
6. Key in CTRL+C. The MDrive sign-on message: "Copyright 2001-2008 by Intelligent Motion Systems, Inc." should appear, verifying that communications is active.

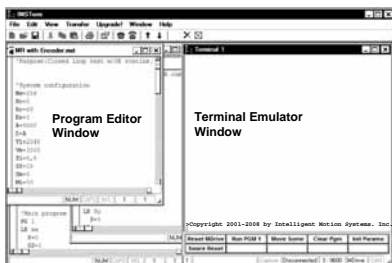

MDrive 34 Motion Control Connectivity Options

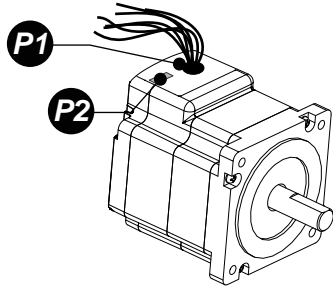

Connector Style **Function**

- P1** Flying Leads..... I/O and Power
- P2** 10-pin IDC..... Communications
- 10-pin Wire Crimp..... Communications

P1 I/O & Power

Flying leads

Wire Color	Function
White/Yellow	I/O1
White/Orange	I/O2
White/Violet	I/O3
White/Blue	I/O4
Green	Analog In
Black	Ground
Red	+V

P2 Communications — RS-422/485

10-pin IDC

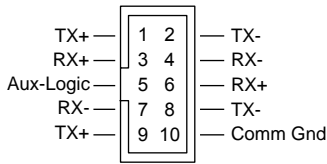

Communications Converter p/n: MD-CC400-001

Electrically isolated in-line USB to RS-422/485 converter pre-wired with mating connector to conveniently program and set configuration parameters.

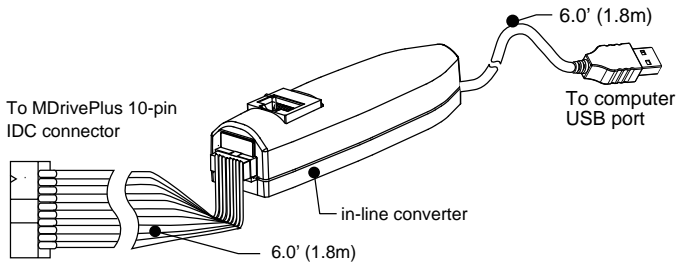

Mating Connector Kit p/n: CK-01

Use to make your own cables, kit contains 5 mating connector shells for making interface cables.

IDC Parts Shell: SAMTEC TCSD-05-01-N
Ribbon Cable: AMP 1-57051-9

P2 Communications — RS-422/485

10-pin wire crimp

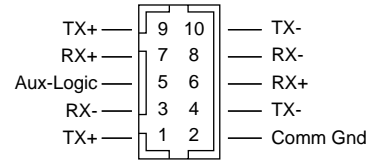

Communications Converter p/n: MD-CC402-001

Electrically isolated in-line USB to RS-422/485 converter pre-wired with mating connector to conveniently program and set configuration parameters.

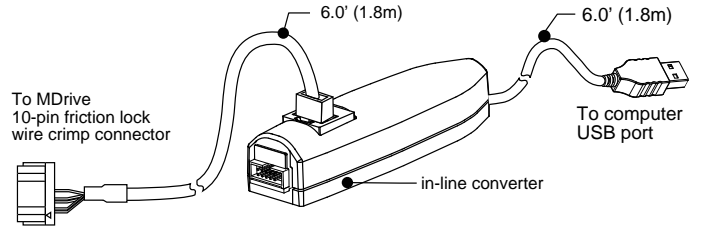

Prototype Development Cable p/n: PD10-1434-FL3

Speed test and development with pre-wired mating connector. Recommended for multi-drop systems, can be used in conjunction with the MD-CC402-001.

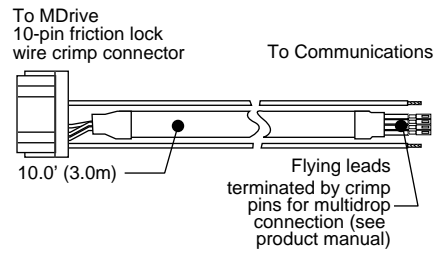

Wire Colors	Function
White/Red Stripe	Aux-Logic
White/Blue Stripe	TX+
Blue/White Stripe	TX-
White/Orange Stripe	RX+
Orange/White Stripe	RX-
Green/White Stripe	GND

Mating Connector Kit p/n: CK-02

Use to make your own cables, kit contains 5 mating connector shells with crimp pins. Hirose crimp tool recommended.

Hirose Parts Shell: DF11-10DS-2C
Pins: DF11-2428SC