

MDrive® 23 IP65 Motion Control



General Specifications

Electrical Specifications	
Input Voltage (+V) Range*	+12 to +75 VDC
Max Power Supply Current (Per MDrive 23)*	2 A
Aux-Logic Input Voltage**	+12 to +24 VDC
Aux-Logic Input Current**	194 mA Max

*Actual power supply current will depend on voltage and load.
 **Used to power logic circuitry in the absence of +V.

Environmental Specifications		
Operating Temperature (non-condensing)	Heat Sink	-40°C to +85°C
	Motor	-40°C to +100°C
Sealing		IP65 Compliant

I/O Specifications	
General Purpose I/O - Number and Type	
I/O Points 1-4, 9-12	8 I/O programmable as inputs or outputs (sinking or sourcing)
General Purpose I/O - Electrical	
Inputs	TTL up to +24 VDC
Sinking Outputs	Up to +24 VDC
Sourcing Outputs	+12 to +24 VDC
Output Sink Current	up to 600 mA (One Channel in each I/O Bank)
Logic Threshold (Logic 0)	< 0.8 VDC
Logic Threshold (Logic 1)	> 2.2 VDC
Protection (Sinking)	Over Temp, Short Circuit
Protection (Sourcing)	Transient Over Voltage, Inductive Clamp
Analog Input	
Resolution	10 Bit
Range (Voltage Mode)	0 to +5 VDC, 0 to +10 VDC
Range (Current Mode)	4 to 20 mA, 0 to 20mA
Clock I/O	
Types	Step/Direction, Up/Down, Quadrature
Logic Threshold	+5V TTL Input, TTL Output (with 2 kΩ Load to Ground)
Trip Output/Capture Input	
Logic Threshold	+5V TTL Input, TTL Output (with 2 kΩ Load to Ground)

Communications Specifications	
Protocol	RS-422/RS-485
BAUD Rate	4.8k, 9.6k, 19.2k, 38.4k, 115.2 kbps
CANopen Option	
Protocol	CAN 2.0B Active
Communications Profile	CIA DS-301
BAUD Rate	10, 20, 50, 125, 250, 500, 800 kBits/s, 1MBit/s (default)
Note: 800 kbps not supported by the MD-CC500-000 USB to CANopen dongle.	

Motion Specifications	
Microstep Resolution - Open Loop	
Number of Resolutions	20

Available Microsteps Per Revolution									
200	400	800	1000	1600	2000	3200	5000	6400	10000
12800	20000	25000	25600	40000	50000	51200	36000 ¹	21600 ²	25400 ³

1=0.01 deg/μstep 2=1 arc minute/μstep 3=0.001 mm/μstep

Software Specifications	
Program Storage Type/Size	Flash/6384 Bytes
User Program Labels and Variables	192
Party Mode Addresses	62

Mechanical Specifications

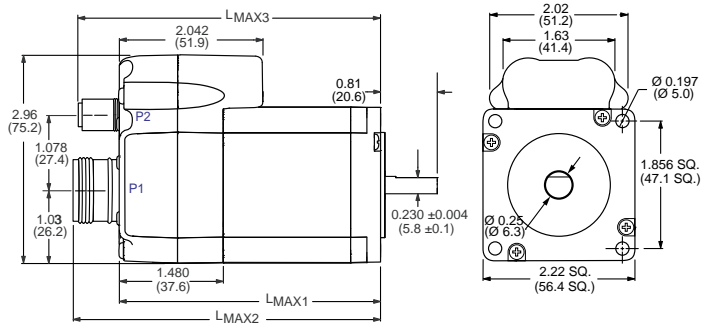

Motor Length	Dimensions in inches (mm)		
	LMAX1	LMAX2	LMAX3
Single	2.82 (71.63)	3.48 (88.39)	3.42 (86.87)
Double	3.16 (80.26)	3.82 (97.03)	3.76 (95.50)
Triple	4.02 (102.11)	4.67 (118.62)	4.62 (117.35)

Notes and Warnings

Installation, configuration and maintenance must be carried out by qualified technicians only. You must have detailed information to be able to carry out this work. This information can be found in the user manuals.

- Unexpected dangers may be encountered when working with this product!
- Incorrect use may destroy this product and connected components!

The user manuals are not included. You can obtain them from the Internet at: <http://www.imshome.com/downloads/manuals.html>.

Required for Setup*

- PC running Microsoft® Windows XP Service Pack 2 or greater.
- IMS Terminal integrated program editor and terminal emulator (available online).
- +12 to +75 VDC unregulated linear or switching power supply.
- RS-422/485 communications interface (recommended: MD-CC401-001 communication converter). Or CANopen communications converter (recommended: MD-CC500-000).

Depending on your MDrive connectors configuration, you may also need:

- I/O and Power interface to 19-pin M23 circular connector (recommended: MD-CS100-000 or MD-CS101-000 prototype development cordset).

* If you purchased your MDrive with a QuickStart Kit, you have received all of the connecting cables needed for initial functional setup and system testing.

Getting Started

All documentation, software and resources are available online at: http://www.imshome.com/products/mdrive_motor_driver.html.

Connecting Power and I/O

Your MDrive is configured with power and I/O combined on a single connector. Please refer to the opposite side of this document for connecting details and available connectivity options including Prototype Development Cables and mating connector recommendations.

Connecting Communications — RS-422/485

1. Connect RS-422/485 communications converter to MDrive and PC.
2. Install the communication converter drivers onto PC (available online).
3. Install and open IMS Terminal.
4. Apply power to MDrive.
5. Within IMS Terminal, click into the Terminal Window (shown below).
6. Key in CTRL+C. The MDrive sign-on message: "Copyright 2001-2008 by Intelligent Motion Systems, Inc." should appear, verifying that communications is active.

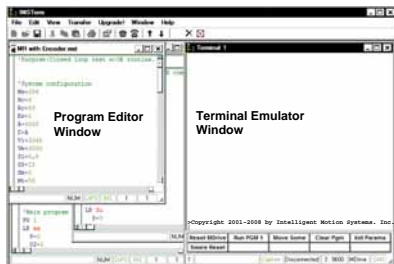

Connecting Communications — CANopen

A "Getting Started" tutorial using the IMS CANopen Tester GUI with the MD-CC500-000 USB to CANopen dongle is located in the CANopen implementation manual, available online.

MDrive 23 IP65 Motion Control Connectivity Options

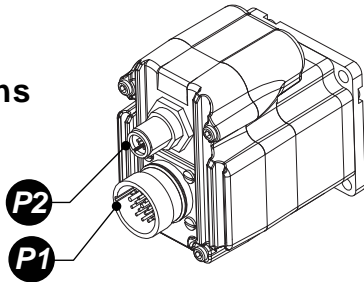

Connector Style	Function
P1 M23 Circular (male)	I/O & Power
P2 M12 Circular (female)	Communications
M12 Circular (male)	Communications (CANopen version)

P1 I/O and Power

19-pin M23 circular connector (male)

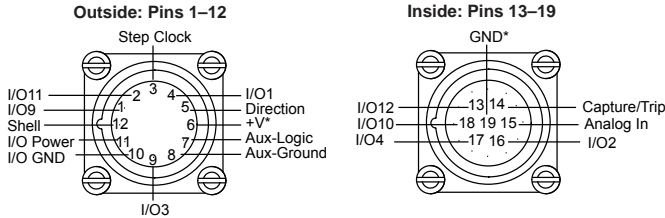

Prototype Development Cable

p/n (straight connector): MD-CS100-000
p/n (right-angle connector): MD-CS101-000

Pre-wired mating connector interfaces to an MDrive 19-pin M23 circular connector, with flying leads other end, for quick test/development.

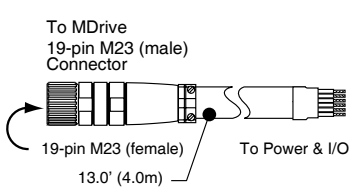

Wire Colors	Function	Encoder Function
Violet	I/O9	Channel A+
Red	I/O11	Channel B+
Gray	Step Clock	Index+
Red/Blue	I/O1	I/O1
Green	Direction	Index-
Blue	+V*	+V*
Gray/Pink	Aux-Logic	Aux-Logic
White/Green	Comm GND	Comm GND
White/Yellow	I/O3	I/O3
White/Gray	I/O GND	I/O GND
Black	I/O Power	I/O Power
Green/Yellow	Shell Connect	Shell Connect
Yellow/Brown	I/O12	Channel B-
Brown/Green	Capture/Trip	Capture/Trip
White	Analog In	Analog In
Yellow	I/O2	I/O2
Pink	I/O4	I/O4
Gray/Brown	I/O10	I/O10
Brown	GND*	GND*

*No Connect on AC Plus units

Mating Connector Recommendations

The MD-CS100-000 is recommended with 19-pin M23 connector.
For comparable connector only, shop vendors:

- Lumberg
- Phoenix
- Turck
- RDE Connectors

P2 Communications — RS-422/485

5-pin M12 circular connector (female)

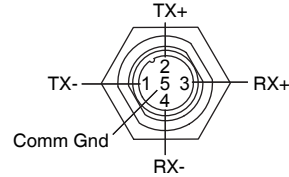

Communications Converter p/n: MD-CC401-001

Electrically isolated in-line USB to RS-422/485 converter pre-wired with mating connector to conveniently program and set configuration parameters.

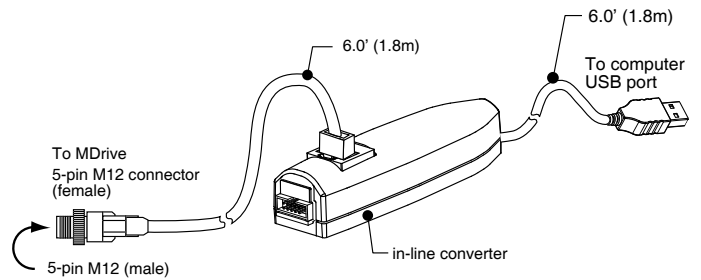

Mating Connector Recommendations

The MD-CC401-001 is recommended with 5-pin M12 connector.
For comparable connector only, shop vendors:

- Lumberg
- Phoenix
- Turck
- RDE Connectors

P2 Communications — CANopen version

M12 (male)

Communications Converter p/n: MD-CC500-000

Electrically isolated in-line USB to CANopen converter. USB "A" Type connector to DB-9 (male). An interface cable must be constructed by the user to interface to the MDrive.

Mating Cable Requirements

The following diagram illustrates the parts and connections for an interface cable connecting the MD-CC500-000 to the MDrive.

Parts Required	Connectors:	(1) DB-9 (female), (1) 5-pin M12 (female)
	Power Supply:	+7 to +30 VDC
	Terminating Resistor:	120 Ω 1%

