

MDrive[®] Hybrid

Integrated motion systems with
Hybrid Motion Technology™



MDrive 23 Hybrid
Step • Torque • Speed



MDrive® Hybrid Step • Torque • Speed
 Sizes: 23, 34 & 34ac

Presentation

The MDrive® Hybrid Step • Torque • Speed is a very compact motion system that solves many servo applications with a low cost solution. The system includes a 1.8° 2-phase stepper motor integrated with a high performance microstepping drive, internal encoder integral to system operation, and Hybrid Motion Technology™ (HMT). HMT combines the best of servo and stepper motor technologies, while delivering unique capabilities and enhancements over both.

MDrive Hybrid integrated motion control systems use RS-422/485 communications. The MDrive Hybrid Step • Torque • Speed systems can be configured to operate in one of four modes:

- Step — in Step/Direction mode, the MDrive Hybrid is controlled by an external step clock signal.
- Torque — in Torque Control mode, the MDrive Hybrid maintains a constant, preset torque output of the motor. The torque may be set in software, or controlled via the analog input using a 0 to +5 V, 0 to +10 V or -10 to +10 V signal.
- Speed — in Speed Control mode, the MDrive Hybrid operates as an intelligent speed control, with velocity being controlled via the analog input by a 0 to +5 V, 0 to +10 V or -10 to +10 V signal.
- Velocity — in Velocity Control mode, the MDrive Hybrid operates at a constant velocity commanded by the slew parameter.

MDrive Hybrid Step • Torque • Speed system settings are via a supplied configuration GUI featuring:

- Easy installation via web interface
- Automatic communication configuration
- Tool-tips display valid range settings for each option

Application areas

The MDrive Hybrid is ideal for machine builders who want a low cost alternative to servo motors and brushed DC motors. The highly compact, integrated electronics of the MDrive Hybrid reduce the potential for problems due to electrical noise by eliminating the cable between motor and drive. This stepper-based system requires no tuning, and provides real-time closed loop control through an internal encoder.

These compact, powerful and cost effective motion control solutions deliver unsurpassed smoothness and performance that will reduce system cost, design and assembly time for a large range of motor applications — both servo and stepper.

Features

- Highly integrated microstepping drive and high torque 1.8° 2-phase stepper motor
- HMT control for exceptional performance
- Internal encoder, with signals available for external use
- Single supply: from +12 up to +75 VDC or 120 and 240 VAC
- Cost effective
- Extremely compact
- 20 microstep resolutions up to 51,200 steps per rev including: Degrees, Metric, Arc Minutes
- Several motor stack lengths available
- Available options:
 - Long life linear actuator (1)
 - Rear control knob for manual position
 - QuickStart Kit
 - Drive Protection Module
- Graphical user interface provided for quick and easy parameter setup

(1) Only available with MDrive23Hybrid systems. See separate documentation.

Step • Torque • Speed specifications			MDrive 23	MDrive 34	MDrive 34 ac	
Input power	Voltage	VDC	12 to 60	12 to 75	—	—
		VAC	—	—	120	240
	Current maximum (1)		3.5A	4A	95 to 132 VAC @ 50/60 Hz	95 to 264 VAC @ 50/60 Hz
Thermal	Operating temp non-condensing	Heat sink	-40° to +85°C	-40° to +75°C	-40° to +75°C	
		Motor	-40° to +100°C	-40° to +90°C	-40° to +90°C	
Temp output warning	Open-drain type		not applicable	+5 to +24 VDC, 50 mA current	+5 to +24 VDC, 50 mA current	
Protection	Type		not applicable	not applicable	- Thermal - Over voltage/current	
Isolated input	Voltage range		+5 to +24 VDC sourcing or sinking			
Motion	Digital filter range		50 nS to 12.9 μS (10 MHz to 38.8 kHz)			
	Clock types (Step mode)		Step/direction, quadrature, step up/step down			
	Step frequency		5 MHz maximum			
			100 ns minimum pulse width			
	Microstep resolution	Number of settings		20		
Steps per revolution			Binary	200, 400, 800, 1600, 3200, 6400, 12800, 25600, 51200, 36000 (0.01 deg/μstep), 21600 (1 arc minute/μstep), 25400 (0.001 mm/μstep)		
		Decimal	1000, 2000, 5000, 10000, 20000, 25000, 40000, 50000			
Encoder	Line counts		100, 200, 250, 256, 400, 500, 512, 1000			
Communication	Type		RS-422/485			
	Baud rate		4.8 to 115.2 kbps			

Setup parameters (2)

A system configuration GUI is provided for ease of setup and configuring your device. The image (right) depicts the GUI's main screen with choice of operating mode, primary and secondary parameter settings.

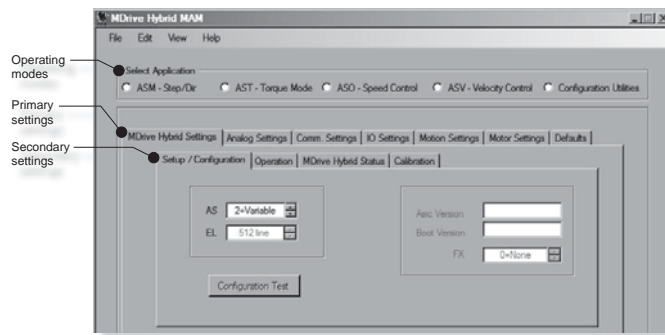

Note that available settings vary with each one of the three operating modes. Shown below is an overview of all settings with general descriptions. More detailed information is covered in the product manual.

		Description
Operating modes	Step & Direction	For point-to-point positioning, clock types: step/direction, quadrature, step up/step down
	Torque Control	Operates in relation to an analog input for positioning to torque setting Resolution: 0 – 100% Accuracy, to scale: ± 5%
	Speed Control	Operates as an independent velocity control device, no external controller required
Hybrid Motion Technology™ (HMT) settings	Setup/configuration	Turn HMT off/on in fixed or variable mode; set and confirm encoder line count
	Operation	Set control bounds for motor torque and speed, lead, lag, and make-up of lost steps
	HMT status	Display status alerts of 8 pre-programmed fields, read-only
	Calibration	To maintain synchronization, select options for motor's rotor-to-stator physical position
General settings	Analog	Enable active
	Communication	Set baud rate; enable/disable parity mode and features; Check Sum integrity quality assurance
	I/O	Clock and filter settings; Attention Output with 11 pre-programmed fields to select among
Defaults		Set various motion settings which vary with the operating mode selected, ex. Current, MSEL
		The Speed Control Mode also includes settings for acceleration, deceleration, velocity and flags
Defaults		Restore system defaults or previously stored settings; view current communication settings

(1) Actual power supply current will depend on voltage and load.

(2) All parameters are set using the supplied system configuration GUI. An optional Communication Converter is recommended with first orders.

 See User Manual for complete details: www.imshome.com/manuals.html

Mechanical specifications, dimensions in inches (mm)

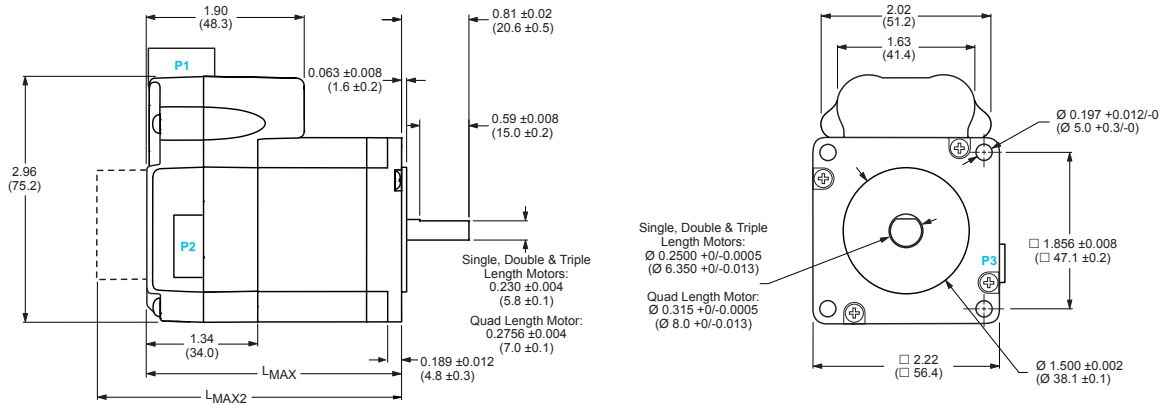

Motor stack length	Lmax (1)	Lmax2 (2)
Single	2.65 (67.31)	3.36 (85.34)
Double	3.02 (76.71)	3.73 (94.74)
Triple	3.88 (98.55)	4.59 (116.59)
Quad	5.28 (134.15)	5.99 (152.19)

(1) Single shaft.
 (2) Control knob.

P1 connector
 I/O & Power

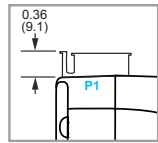

12-pin locking wire crimp connector

P2 connector
 Communication

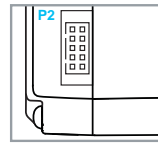

10-pin friction lock wire crimp connector

P3 connector
 Encoder

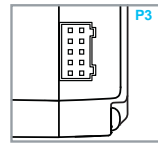

10-pin locking wire crimp connector

Lmax2 option

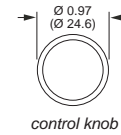

control knob

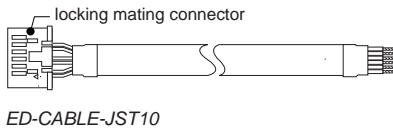
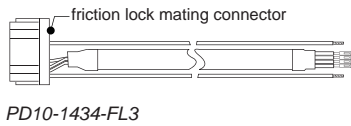
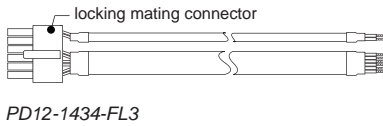
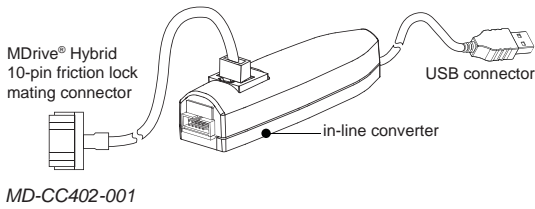

Installation accessories

Description	Length feet (m)	Part number
-------------	-----------------	-------------

QuickStart Kit

For rapid design verification, all-inclusive QuickStart Kits include connectivity, instructions and CD for MDrive Hybrid initial functional setup and system testing.

- For all MDrive23 Step • Torque • Speed systems — add "K" to part number (1)

Communication converter

Electrically isolated, in-line converter pre-wired with mating connector to conveniently set/program communication parameters for a single MDrive Hybrid via a PC's USB port.

- Mates to 10-pin friction lock wire crimp connector 12.0 (3.6) MD-CC402-001

Prototype development cable

Speed test/development with pre-wired mating connector with other cable end open.

- Mates to 12-pin locking wire crimp connector for I/O and power 10.0 (3.0) PD12-1434-FL3
- Mates to 10-pin friction lock wire crimp connector for communication 10.0 (3.0) PD10-1434-FL3
- Mates to 10-pin locking wire crimp connector for encoder 6.0 (1.8) ED-CABLE-JST10

Mating connector kit

Connectors for assembly of cables, cable material not supplied. Sold in lots of 5. Manufacturer's crimp tool recommended for crimp connectors.

- 12-pin locking wire crimp connector for I/O and power — CK-03
- 10-pin friction lock wire crimp connector for communication — CK-02
- 10-pin locking wire crimp connector for encoder — CK-13

Drive protection module

Limits surge current and voltage to a safe level when DC input power is switched on-and-off to an MDrive Hybrid.

- For all MDrive23 Step • Torque • Speed systems — DPM75

(1) See page 16.

MDrive® 23 Hybrid

Step • Torque • Speed

MDrive® 23 Hybrid



- P1: I/O and Power**
12-pin locking wire crimp connector
- P3: Encoder**
10-pin locking wire crimp connector (not visible)
- P2: Communication**
10-pin friction lock wire crimp connector

Step • Torque • Speed													
Part numbers													
Example:	K	M	A	M	3	C	R	L	2	3	A	6	-EAM-N
QuickStart Kit K = kit option, or leave blank if not wanted	K	M	A	M	3	C	R	L	2	3	A	6	-EAM-N
MDrive Hybrid version MAM = Step•Torque•Speed	K	M	A	M	3	C	R	L	2	3	A	6	-EAM-N
Type 3 = HMT	K	M	A	M	3	C	R	L	2	3	A	6	-EAM-N
P1 connector C = wire crimp						C							
Communication R = RS-422/485	K	M	A	M	3	C	R	L	2	3	A	6	-EAM-N
P2 connector L = wire crimp	K	M	A	M	3	C	R	L	2	3	A	6	-EAM-N
Motor size 23 = NEMA 23 (2.3" / 57 mm)	K	M	A	M	3	C	R	L	2	3	A	6	-EAM-N
Motor length A = single stack B = double stack C = triple stack D = quad stack	K	M	A	M	3	C	R	L	2	3	A	6	-EAM-N
Drive voltage 6 = +12 to +60 VDC	K	M	A	M	3	C	R	L	2	3	A	6	-EAM-N
Encoder, differential internal encoder with index mark, signals available for external use (1) -EAM = 100 line count -EBM = 200 line count -ECM = 250 line count -EWM = 256 line count -EDM = 400 line count -EHM = 500 line count -EXM = 512 line count -EJM = 1000 line count	K	M	A	M	3	C	R	L	2	3	A	6	-EAM-N
Options Leave blank if not wanted -N = rear control knob for manual positioning													-N

(1) Size 23 systems have magnetic encoders.
NOTE: system performance is optimized with higher encoder resolution selections.



Easy MDrive part numbers via an interactive tool at:
www.imshome.com/MDrivePlus.html

Motor specifications MDrive 23 Hybrid

		Holding torque	Detent torque	Rotor inertia	Weight (motor + driver)
Motor stack length	Single	90.0 oz-in / 64.0 N-cm	3.9 oz-in / 2.7 N-cm	0.0025 oz-in-sec ² / 0.18 kg-cm ²	21.6 oz / 612.3 g
	Double	144.0 oz-in / 102.0 N-cm	5.6 oz-in / 3.92 N-cm	0.0037 oz-in-sec ² / 0.26 kg-cm ²	26.4 oz / 748.4 g
	Triple	239.0 oz-in / 169.0 N-cm	9.7 oz-in / 6.86 N-cm	0.0065 oz-in-sec ² / 0.46 kg-cm ²	39.2 oz / 1111.3 g
	Quad	283.0 oz-in / 200.0 N-cm	14.2 oz-in / 10.0 N-cm	0.0108 oz-in-sec ² / 0.76 kg-cm ²	61.6 oz / 1746.3 g

Speed torque characteristics MDrive 23 Hybrid

Single stack length Double stack length

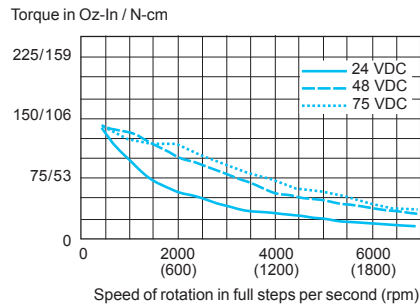
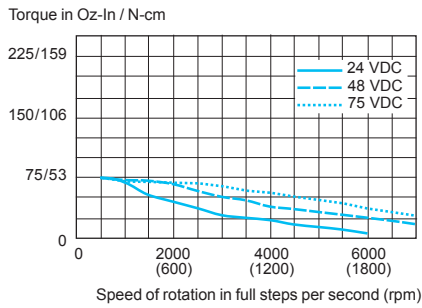

Triple stack length Quad stack length

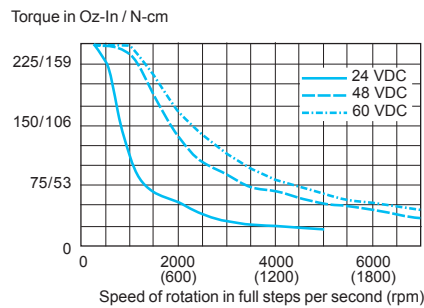
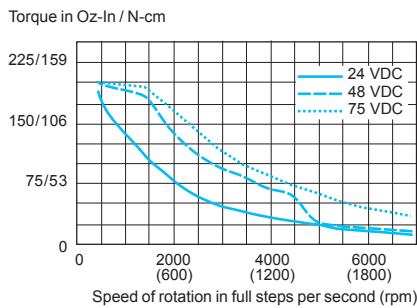

USA SALES OFFICES

Eastern Region

Tel. 862 208-9742 - Fax 973 661-1275

e-mail: e.region@imshome.com

Northeast Region

Tel. 860 368-9703

e-mail: n.region@imshome.com

Central Region

Tel. 860 295-6102

e-mail: c.region@imshome.com

Western Region

Tel. 602 578-7201

e-mail: w.region@imshome.com

IMS EUROPEAN SALES MANAGEMENT

4 Quai Des Etroits

69005 Lyon, France

Tel. +33/4 7256 5113 - Fax +33/4 7838 1537

e-mail: europa.sales@imshome.com

TECHNICAL SUPPORT

Tel. +00 (1) 860 295-6102 - Fax +00 (1) 860 295-6107

e-mail: etech@imshome.com

Schneider Electric Motion USA

370 North Main Street, P.O. Box 457

Marlborough, CT 06447 - U.S.A.

Tel. +00 (1) 860 295-6102 - Fax +00 (1) 860 295-6107

e-mail: info@imshome.com

www.schneider-electric-motion.us